



VORTICE

vortice.com



INDUSTRIAL VENTILATION 

CATALOGUE

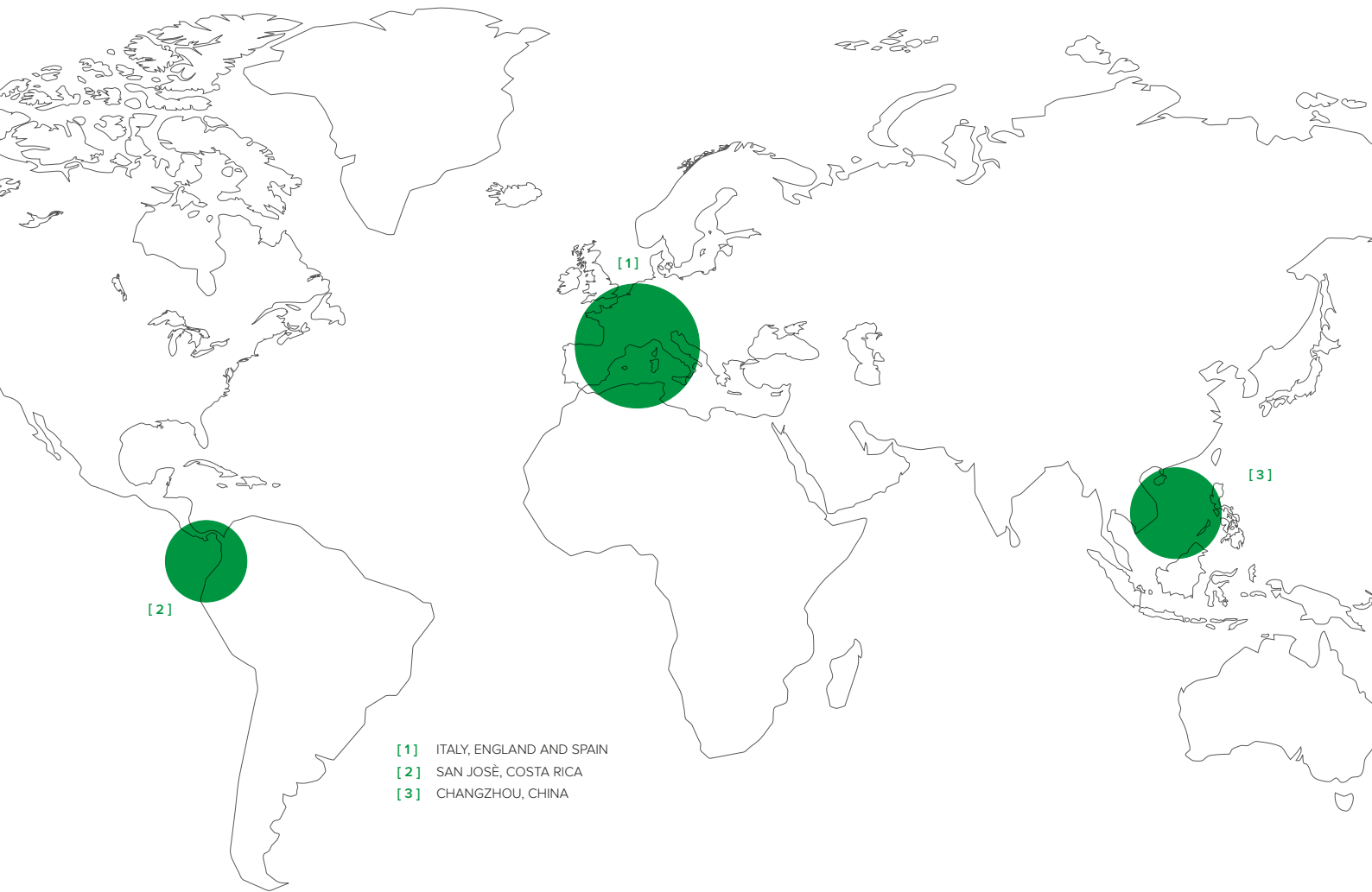

- [1] ITALY, ENGLAND AND SPAIN
- [2] SAN JOSÉ, COSTA RICA
- [3] CHANGZHOU, CHINA



Vortice Headquarters

Today **VORTICE S.p.A.** is part of a multinational group, **VORTICE GROUP**, which operates through its own companies or local distributors in over 90 countries worldwide and has a rich portfolio of products that guarantee air quality and climate comfort. The historical headquarters of **VORTICE S.p.A.** are in Tribiano (Milan).

The **VORTICE GROUP** also includes:

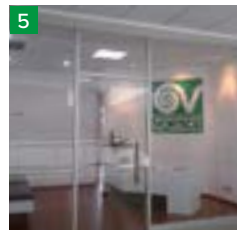
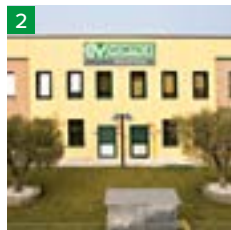

- 1** **VORTICE UK Ltd**, English branch opened in 1977 based in Burton on Trent.
- 2** **VORTICE INDUSTRIAL**, born from the acquisition in 2010 of Loran srl, based in Isola della Scala (VR).
- 3** **CASALS** historic Spanish brand of VENTILACIÓN INDUSTRIAL IND. S.L., based in Sant Joan de les Abadesses, Girona, acquired in 2019.

- 4** **VORTICE Ventilation System**, company inaugurated in 2013 with headquarters in Changzhou China.
- 5** **VORTICE Latam**, based in San José, Costa Rica, established in 2012.

INDEX



VORTICEL E RANGE page 04 Low-pressure plate axial fans	VORTICENT C E RANGE page 86 Centrifugal fans
VORTICEL A-E RANGE page 14 Low-pressure plate axial fans	E-ATEX RANGE page 98 Axial plate-mounted fans for installation in potentially explosive areas
VORTICEL MP RANGE page 24 Medium-pressure plate axial fans	C-ATEX RANGE page 104 Centrifugal fans for installation in potentially explosive areas
VORTICEL MPC-E RANGE page 32 Medium-pressure long cased axial fans	TORRETTE RF-EU RANGE page 110 Centrifugal roof fans with horizontal discharge
VORT JET A RANGE page 38 Impulse axial jet fans	TORRETTE TR-E RANGE page 120 Centrifugal roof fans for horizontal discharge
VORT JET A F400 RANGE page 44 Impulse axial jet fans	TORRETTE TR-E-V RANGE page 128 Centrifugal roof fans with vertical discharge
VORT JET R RANGE page 50 Induction centrifugal jet fans	TORRETTE TR-ED RANGE page 136 Centrifugal roof fans with horizontal discharge for hot fumes extraction
VORT JET R F400 RANGE page 54 Induction centrifugal jet fans	TORRETTE TR-ED-V RANGE page 146 Centrifugal roof fans with vertical discharge for hot fumes extraction
MPC-ED RANGE page 58 Fully cased axial flow fans	ACCESSORIES page 156
MPC-HP RANGE page 64 Fully cased axial flow fans	CONTROLLERS page 164
MPC-ED F400 RANGE page 76 Fully cased axial flow fans	

Ranges in the following are CE marked in compliance with the Directives and regulations listed below:

• Machine Directive (2006/42/CE)	Standards relevant to Machinery Directive	Standards relevant to Electromagnetic Compatibility Directive
• EMC wDirective (2014/30/CE)	• EN 60204-1	• EN 55014-1
• Erp Directive (2009/125/CE)	• EN 12100	• EN 55014-2
• Erp Regulation N° 327/2011	• EN 12499	• EN 61000-3-2
	• EN 13857	• EN 61000-3-3

Certification of conformity (EN 12101-3)

Standards relevant to performances measurement (ISO 5801)

Standards relevant to hot fumes extraction (EN 12101-3)



VORTICEL E RANGE

Low-pressure plate axial fans

Industrial wall-mounted axial fans, available in different diameters and in single and three-phase versions, designed for the ventilation of commercial and industrial premises, such as gyms, dry cleaners, joineries, garages, warehouses and stables.

Key features

- Robust and weatherproof construction.
- Motors with high (IP44) degree of protection against dust and water.

Versions

- 7 models, in single and three-phase versions, with 2 and 4 poles, with a nominal diameter between 250 and 350 mm.
- 12 models, in single and three-phase versions, with 2 and 4 poles, with a nominal diameter between 300 and 600 mm, available only for the extra EU market.

Technical features

- Wall panels made of pressed steel, pickled, phosphated and epoxy powder-coated with hammered effect finish, guaranteeing long-term resistance to aggressive agents, in grey colour with hammered finish.
- Ventilation ports, fashioned in one piece with the wall panels, gauged to optimize airflow.
- Safety and anti-bird protective grilles designed in accordance with the UNI ISO 13857 standard combining the function of motor bracket, made of electrically welded steel rings with epoxy black paint finish. Easy removal simplifies the maintenance and cleaning of the fan.
- Class F thermally protected asynchronous motors, with shafts turning on ball bearings with double sealing screen, characterized by high (IP44) degree of protection against dust and water, speed adjustable by Vortex controllers.
- Starting capacitors of the single-phase models comply with the EN 60252-1 standard and are third-party certified.
- Impellers with 6-fin shaped blades fitted on grooved hubs in die-cast aluminium, dynamically balanced (UNI ISO 1940, Class 6.3), moulded in plastic resin loaded with glass fibres to combine dimensional stability, strength and resistance to aggressive agents.
- Degree of protection against dust and water: IP44.
- Electrical insulation class: I (grounding required).

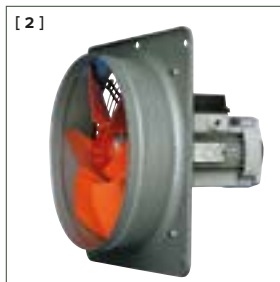
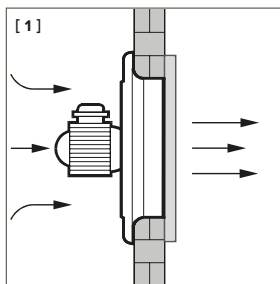

[1] These devices are suitable for applications that do not require the overcoming of load losses and for the extraction of non-dusty, non-acid or corrosive air.

[2] Side profile

Note

- The fans of the VORTICEL E range comply with Reg. ErP No. 327/2011/UE.
- The fans of the VORTICEL E range are designed for applications not characterized by high pressure drops and in the absence of significant concentrations of abrasive powders or acid or corrosive substances.



TECHNICAL DATA

	PRODUCTS	CODE	V~50HZ	W	A	POLES	RPM	MAX AIRFLOW		MAX PRESSURE		Lp dB(A) * 3 m	MAX °C**	KG
								m³/h	l/s	mmH₂O	Pa			
SINGLE-PHASE	E 252 M	40203	220-240	95-105	0.45-0.47	2	2800	1500	416.7	20.0	196	71.0	70	3.5
	E 254 M	40303	220-240	55-65	0.31-0.39	4	1400	1000	277.8	6.7	66	50.5	60	3.0
	E 304 M	40503	220-240	55-70	0.33-0.40	4	1400	1360	377.8	7.5	74	54.0	65	3.0
	E 354 M	40703	220-240	85-95	0.44-0.45	4	1400	1850	514.0	4.6	45	66.5	65	4.0
THREE-PHASE	E 254 T	40356	220-380 240-415	55 70	0.35/0.20 0.40/0.23	4	1400	1000	277.8	7.3	71	53.0	55	3.0
	E 304 T	40556	220-380 240-415	65 80	0.32/0.19 0.38/0.22	4	1400	1400	389.0	8.2	81	53.0	50	3.0
	E 354 T	40756	220-380 240-415	90 100	0.34/0.20 0.38/0.22	4	1400	1900	528.0	7.1	70	61.0	60	4.0

*Sound pressure level measured at 3 m in free field conditions in accordance with standard ISO 3741.

** Maximum continuous operating temperature of the product.

AVAILABLE ONLY FOR THE EXTRA EU MARKET

	PRODUCTS	CODE	V~50HZ	W	A	POLES	RPM	MAX AIRFLOW		MAX PRESSURE		Lp dB(A) * 3 m	MAX °C**	KG
								m³/h	l/s	mmH₂O	Pa			
SINGLE-PHASE	E 302 M	40403	220-240	190-195	0.85-0.90	2	2800	2350	653	31.5	309	66.0	70	3.0
	E 404 M	40903	220-240	190-200	0.90-0.95	4	1400	3150	875	12.0	118	57.0	70	5.0
	E 454 M	41153	220-240	195-210	0.93-0.95	4	1400	3900	1083	9.0	88	66.0	70	7.0
	E 504 M	41219	220-240	200-220	0.90-0.92	4	1400	4500	1250	6.0	59	61.5	70	8.6
	E 604 M	41459	220-240	320-354	1.45-1.45	4	1400	7000	1944	8.2	80	69.0	65	10.0
THREE-PHASE	E 302 T	40456	220-380 240-415	180 200	0.78-0.44 0.40-0.23	2	2800	2400	667	32.5	319	65.0	70	3.0
	E 404 T	40956	220-380 240-415	190 200	0.60-0.35 0.65-0.38	4	1400	3200	889	17.7	174	60.0	70	5.0
	E 454 T	41154	220-380 240-415	230 240	0.69-0.40 0.72-0.42	4	1400	3900	1083	15.0	147	66.0	70	7
	E 504 T	41154	220-380 240-415	235 245	0.74-0.43 0.74-0.43	4	1400	4800	1333	11.7	115	61.5	70	8.6
	E 506 T	41206	220-380 240-415	145 165	0.43-0.25 0.46-0.27	6	1000	3900	1083	6.8	67	56.0	70	8.5
	E 604 T	41457	220-380 240-415	360 380	1.00-0.62 1.00-0.62	4	1400	7700	2139	14.5	142	69.5	70	10.0
	E 606 T	41506	220-380 240-415	145 165	0.44-0.26 0.46-0.27	6	1000	4800	1333	4.7	46	65.0	70	10.0

*Sound pressure level measured at 3 m in free field conditions in accordance with standard ISO 3741.

** Maximum continuous operating temperature of the product.



INDUSTRIAL VENTILATION

VORTICEL E RANGE

DIMENSIONS

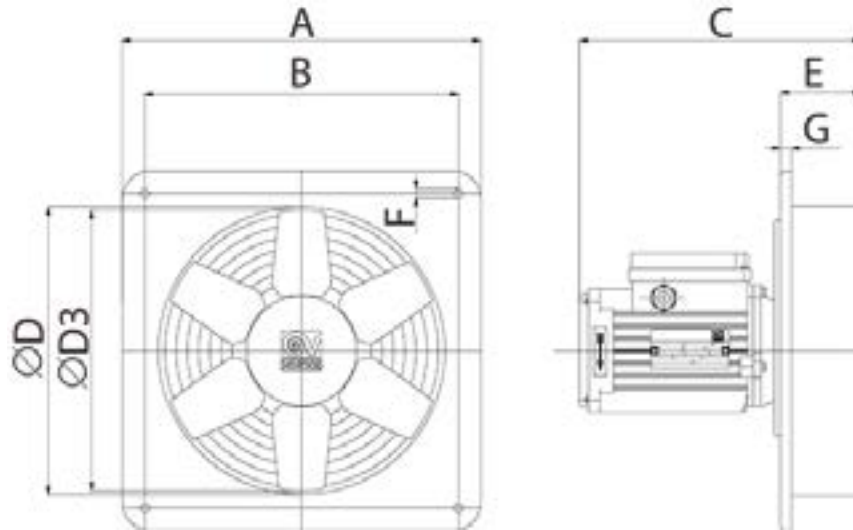

PRODUCTS	A	B	C	ØD	ØD3	E	F	G
E 252 M	320	280	201	256	250	68	8	10
E 254 M	320	280	201	256	250	68	8	10
E 254 T	320	280	201	256	250	68	8	10
E 302 M	380	330	254	308	300	70	8	10
E 302 T	380	330	254	308	300	70	8	10
E 304 M	380	330	203	308	300	70	8	10
E 304 T	380	330	203	308	300	70	8	10
E 354 M	450	380	203	360	350	70	8	10
E 354 T	450	380	203	360	350	70	8	10
E 404 M	510	430	274	410	400	90	12	15
E 404 T	510	430	274	410	400	90	12	15
E 454 M	630	530	269	460	450	85	12	15
E 454 T	630	530	269	460	450	85	12	15
E 504 M	630	530	269	510	500	85	12	15
E 504 T	630	530	269	510	500	85	12	15
E 506 T	630	530	269	510	500	85	12	15
E 604 M	760	630	283	610	600	100	12	15
E 604 T	760	630	283	610	600	100	12	15
E 606 T	760	630	285	610	600	100	12	15

Dimensions (mm)



PERFORMANCE CURVES

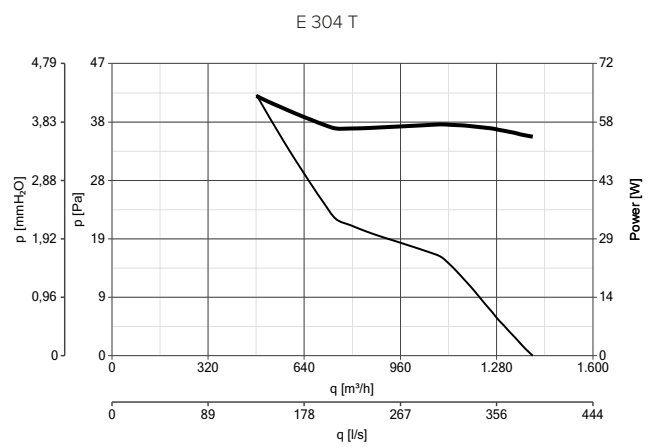
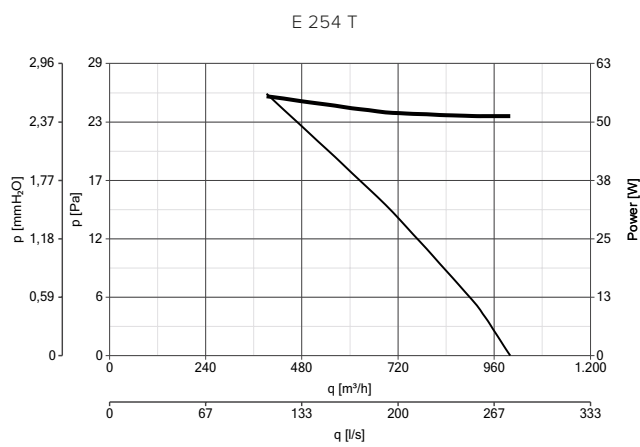
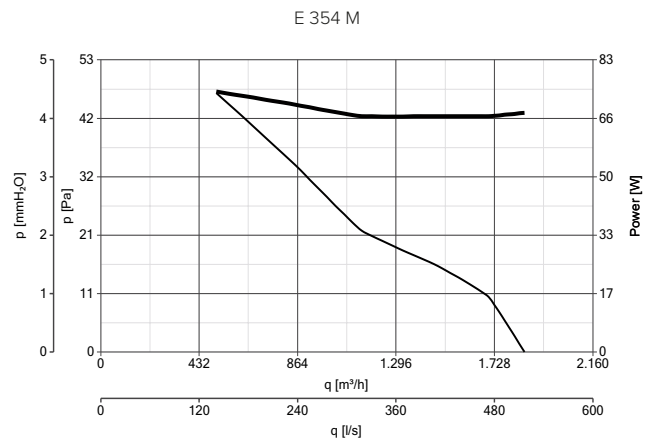
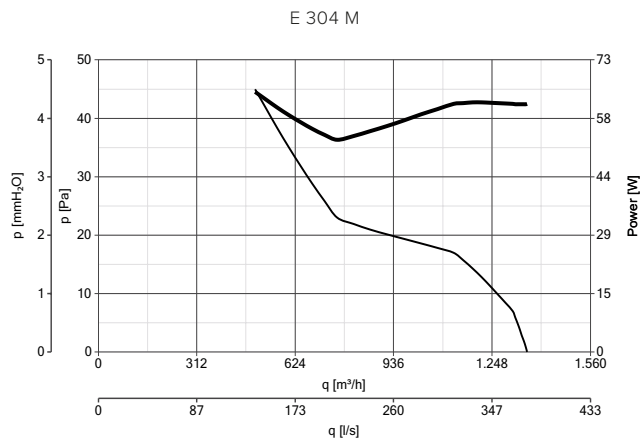
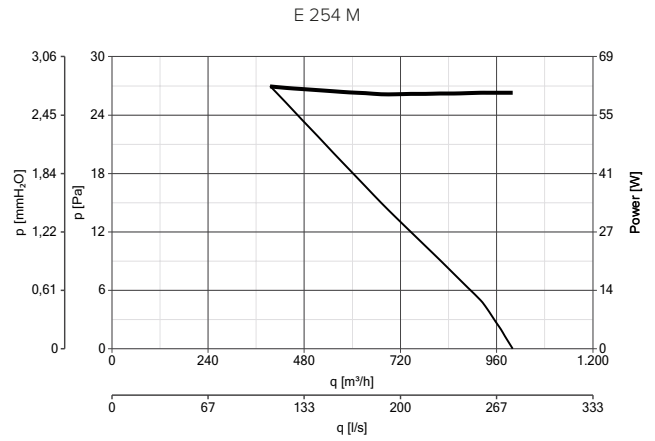
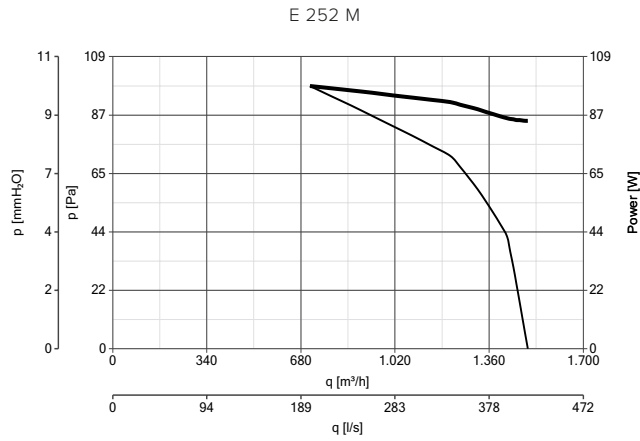

Power consumption
 Delivery



INDUSTRIAL VENTILATION

VORTICEL E RANGE

PERFORMANCE CURVES

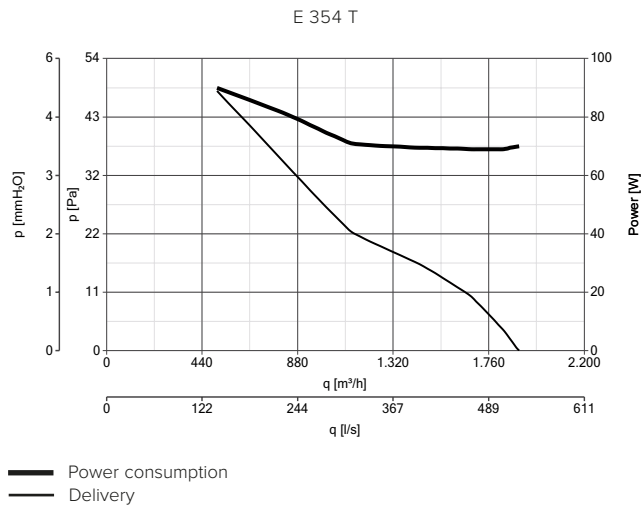



PERFORMANCE CURVES (AVAILABLE ONLY FOR THE EXTRA EU MARKET)

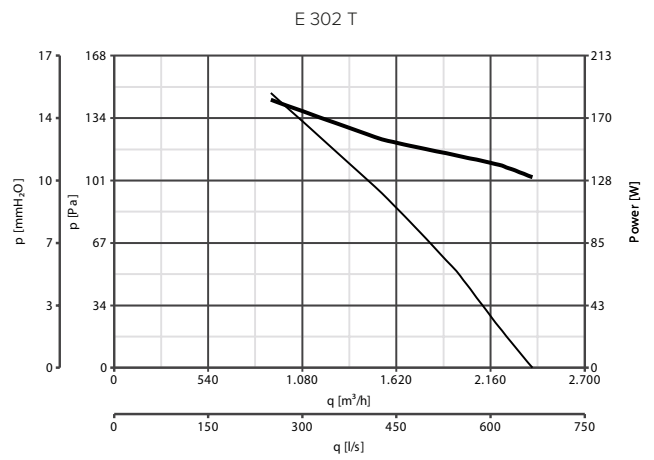
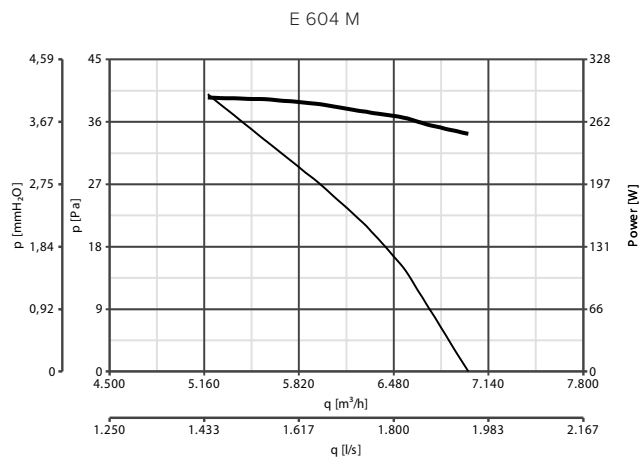
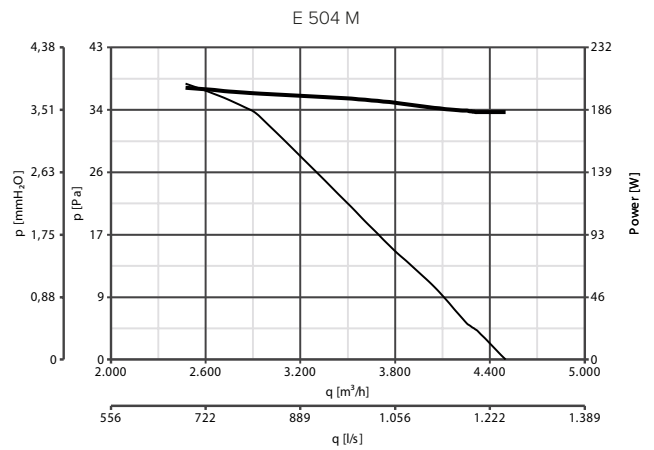
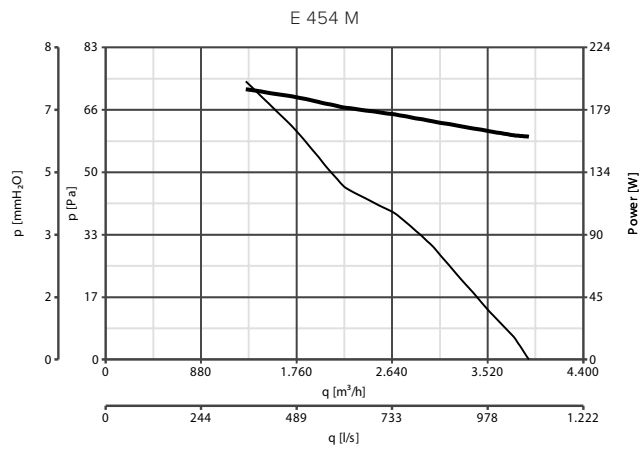
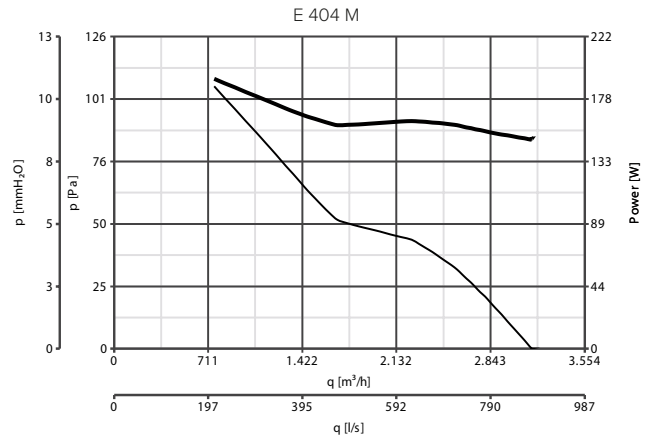
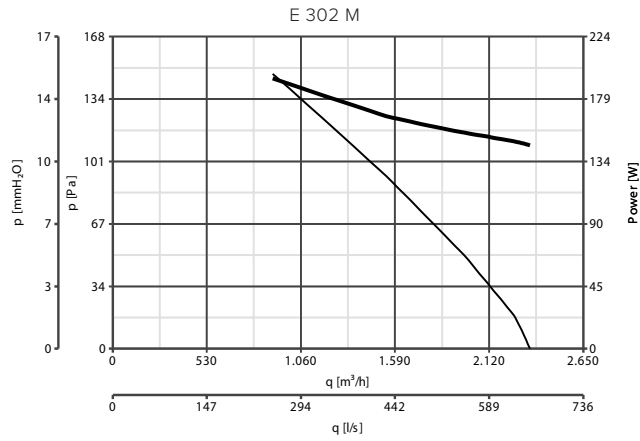

Power consumption
 Delivery



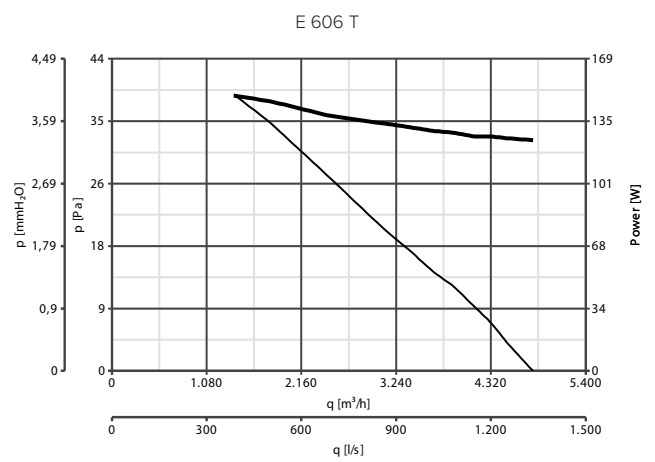
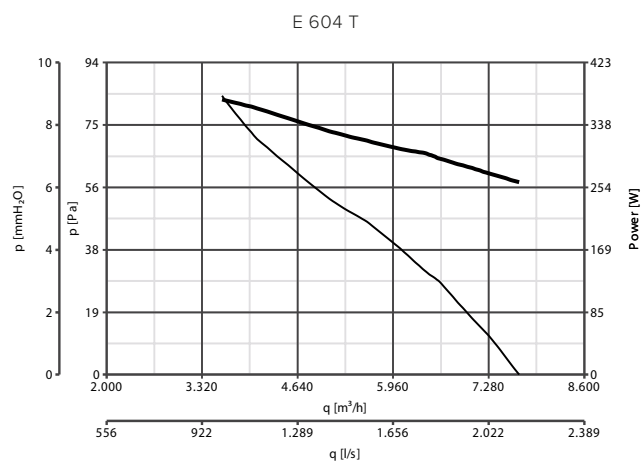
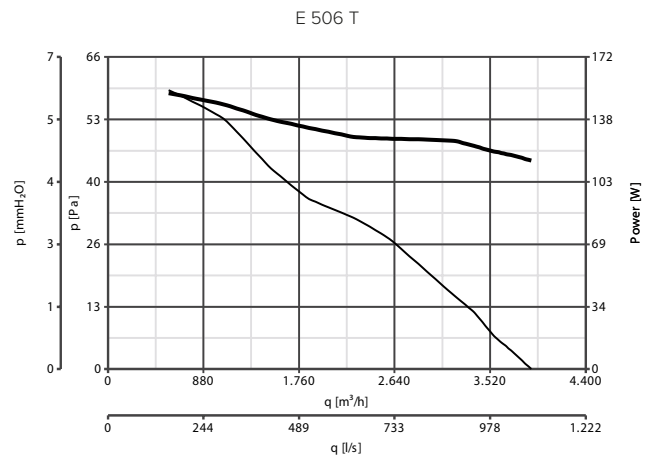
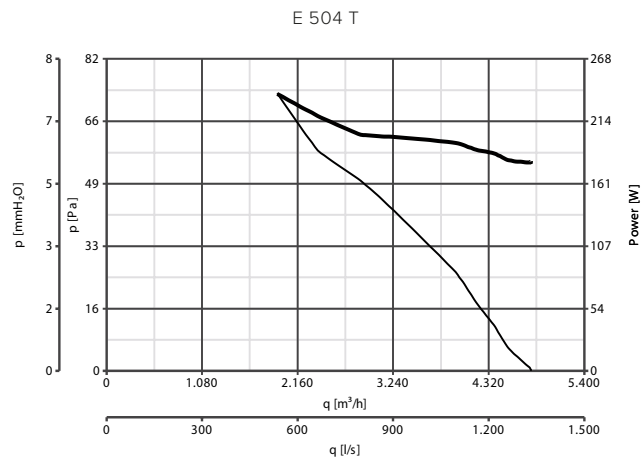
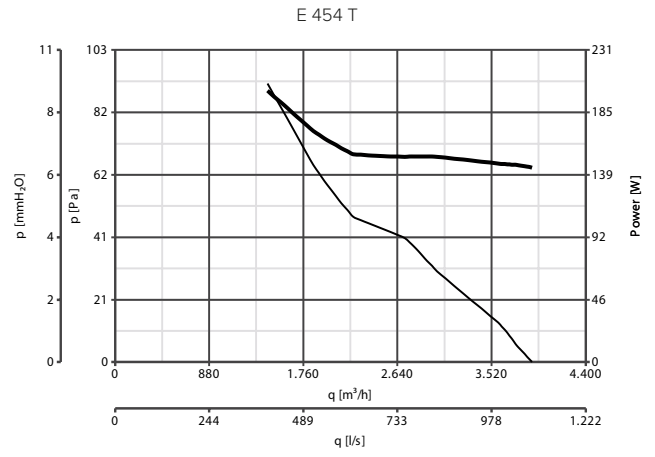
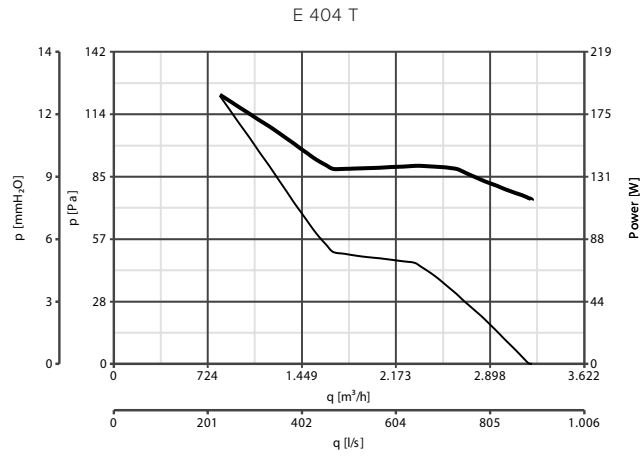

PERFORMANCE CURVES







— Power consumption
— Delivery



ACCESSORIES

MODELS	DESCRIPTION	CODE	PRODUCTS
	DPU - Spacer for panel installation	250	52151 40203 - 40303 - 40356
		300	52251 40503 - 40556 - 40403 - 40456
		350	52351 40703 - 40756
		400	52251 40903 - 40956 - 41154
	PGR - Gravity shutter	250	50150 40203 - 40303 - 40356
		300	50250 40503 - 40556 - 40403
		350	50350 40703 - 40756
	TRA - Frame with safety net	250	51150 40203 - 40303 - 40356
		300	51250 40503 - 40556 - 40403
		350	51350 40703 - 40756

CONTROLLERS

MODELS	DESCRIPTION	CODE	PRODUCTS
	IRM 30 - Three position single-phase speed controller	12921	40203 - 40303 - 40503 - 40703 40403 - 40903 - 41153 - 41459
	IRT 15 - Three position three-phase speed controller	12923	40356 - 40556 - 40756 - 40456 - 40956 - 41157 - 41154 - 41206 - 41457 41506
	IREM 3 - 3A Single-phase speed controller	12931	40203 - 40303 - 40503 - 40703 40403 - 40903 - 41153 - 41459
	IREM 5 - 5A Single-phase speed controller *	12932	40203 - 40303 - 40503 - 40703 40403 - 40903 - 41153 - 41459
	IREM 9 - 9A Single-phase speed controller **	12933	40203 - 40303 - 40503 - 40703 40403 - 40903 - 41153 - 41459
	IREM INVERTER 4 M - Single-phase speed controller with inverter***	12815	40203 - 40303 - 40503 - 40703 40403 - 40903 - 41219 - 41459 - 41153
	IRET INVERTER 2.5 M - Three-phase speed controller with inverter***	12816	40356 - 40556 - 40756 - 40456 40956 - 41154 - 41157 - 41206 - 41457 41506
	POT - Potentiometer	12828	12815 - 12816

*Can control several fans up to a max 5A.

** Intended to simultaneously control appliance, up to a max 9A.

*** To adjust a regulator with inverter, combine a 0-10V potentiometer as code 12828



INDUSTRIAL VENTILATION

VORTICEL E RANGE







VORTICEL A-E RANGE

Low-pressure plate axial fans

Industrial wall-mounted slim axial fans, available in different diameters and in single and three phase versions, designed for the ventilation of commercial and industrial premises, such as offices, gyms, restaurants, discos, dry cleaners and warehouses.

Key features

- Reduced axial clearance
- Possibility of installation in the presence of pressure drops (e.g. discharge via duct or through filters)
- Robust and weatherproof construction.
- Motors with high (IP54) degree of protection against dust and water.

Versions

- 19 models, in single and three-phase versions, with 2, 4 and 6 poles, with a nominal diameter between 250 and 630 mm.

Technical features

- Wall panels made of pressed steel, pickled, phosphated and epoxy powder coated with hammered effect finish, guaranteeing long-term resistance to aggressive agents, in grey colour with hammered finish.
- Ventilation ports, fashioned in one piece with the wall panels, elongated profile, gauged to optimize airflow.
- Safety and anti-bird protective grilles designed in accordance with the UNI ISO 13857 standard combining the function of motor bracket, made of electrically welded steel rings with epoxy black paint finish. Easy removal simplifies the maintenance and cleaning of the fan.
- Class F thermally protected asynchronous rotor type motors in order to contain the axial clearance of the fan, with shafts mounted on double shielded ball bearings, characterized by high (IP54) degree of protection against dust and water, speed adjustable by Vortex controllers.
- Starting capacitors of the single-phase models comply with the EN 60252-1 standard and are third-party certified.
- Dynamically balanced impeller (UNI ISO 1940, Class 6.3); variable number of blades from 4 to 7 according to the model, moulded in electrically galvanised sheet steel and polyester powder-coated.

Note

- The fans of the VORTICEL A-E range comply with Reg. ErP No. 327/2011/EU.
- The fans of the VORTICEL A-E range are compatible with applications that envision high pressure drops, such as those induced by discharge into ventilation ducts or by coupling to air filters. They are not suitable for handling flows characterized by significant concentrations of abrasive powders or acid or corrosive substances.

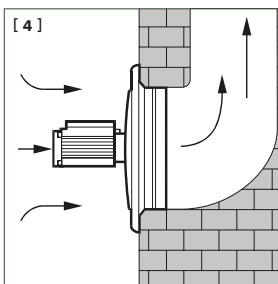
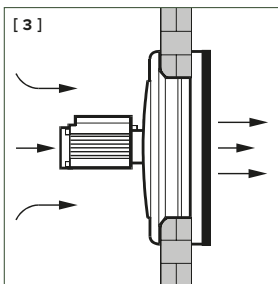
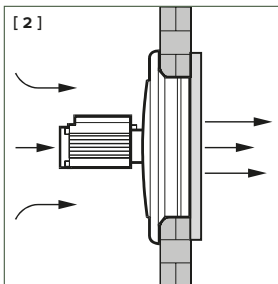

[1] Reduced thickness. [2] [3] [4] These devices can be applied with exhaust in the ventilation duct combined with filters used in all installations where there are pressure drops. The ventilated air must not be dusty, acidic or corrosive.



TECHNICAL DATA

	PRODUCTS	CODE	V~50HZ	W	A	POLES	RPM	MAX AIRFLOW		MAX PRESSURE		Lp dB(A)* 3 m	MAX °C**	KG
								m³/h	l/s	mmH ₂ O	Pa			
SINGLE-PHASE	A-E 252 M	42207	220-240	95	0.41	2	2500	1365	379	379	177	53.0	50	2.1
	A-E 254 M	42208	220-240	38	0.17	4	1400	764	212	212	61	38.5	50	2.1
	A-E 304 M	42216	220-240	81	0.35	4	1400	1563	434	434	130	43.0	50	3.0
	A-E 354 M	42258	220-240	170	0.75	4	1400	2960	822	822	100	49.5	50	6.2
	A-E 404 M	42260	220-240	300	1.33	4	1400	4310	1197	1197	152	55.6	50	9.3
	A-E 454 M	42307	220-240	270	1.19	4	1400	5250	1458	1458	127	54.8	50	15.0
	A-E 504 M	42316	220-240	482	2.12	4	1400	6639	1844	1844	186	59.0	50	13.2
	A-E 506 M	42337	220-240	290	1.27	6	1000	4805	1335	1335	152	57.2	50	17.6
	A-E 566 M	42356	220-240	350	1.60	6	1000	6715	1865	1865	134	57.2	50	24.2
	THREE-PHASE	A-E 254 T	42357	380-415	50	0.22	4	1400	785	218	218	134	39.0	50
A-E 304 T		42227	380-415	79	0.22	4	1400	1696	471	471	129	46.0	50	3.4
A-E 354 T		42259	380-415	166	0.35	4	1400	2980	828	828	115	48.7	50	6.2
A-E 404 T		42261	380-415	318	0.65	4	1400	3832	1064	1064	246	62.5	50	6.3
A-E 454 T		42308	380-415	370	0.73	4	1350	5187	1440	1440	155	58.0	50	6.5
A-E 504 T		42327	380-415	485	1.12	4	1400	6966	1935	1935	128	60.5	40	11.1
A-E 506 T		42346	380-415	250	0.79	6	1000	5040	1400	1400	96	52.7	50	15.0
A-E 564 T		42336	380-415	925	1.71	4	1400	9255	2570	2570	285	54.9	40	14.8
A-E 566 T		42366	380-415	480	1.06	6	1000	8050	2236	2236	175	56.7	50	20.8
A-E 636 T		42347	380-415	522	1.10	6	1000	9502	2639	2639	154	58.0	50	15.8

*Sound pressure level measured at 1 and 3 m in free field conditions in accordance with standard ISO 3741.

** Maximum continuous operating temperature of the product.



INDUSTRIAL VENTILATION

VORTICEL A-E RANGE

ERP DATA DIRECTIVE N° 327/2011/UE

	PRODUCTS	CODE	MEASUREMENT CAT.	EFFICIENCY CAT.	YEAR OF CONSTRUCTION	VARIABLE DRIVE	η	N.	kW Pe	m ³ /h q	BEP* Pa p	RPM	Spec. ratio <1.04
SINGLE-PHASE	A-E 354 M	42258	A	STATIC	2015	NO	29.0	41.0	0.1450	1975	74.1	1333	YES
	A-E 404 M	42260	A	STATIC	2015	NO	32.1	42.0	0.2282	3121	84.6	1375	YES
	A-E 454 M	42307	A	STATIC	2015	NO	31.6	41.5	0.2749	3501	89.4	1309	YES
	A-E 504 M	42316	A	STATIC	2013	NO	32.2	41.0	0.3972	4749	101	1285	YES
	A-E 506 M	42337	A	STATIC	2015	NO	29.9	40.0	0.2293	3681	67.1	924	YES
	A-E 566 M	42356	A	STATIC	2015	NO	32.7	42.0	0.2816	4468	74.3	891	YES
	A-E 354 T	42259	A	STATIC	2015	NO	29.5	41.0	0.1415	2107	71.2	1332	YES
THREE-PHASE	A-E 404 T	42261	A	STATIC	2013	NO	29.2	40.0	0.2078	2376	96	1428	YES
	A-E 454 T	42308	A	STATIC	2013	NO	30.8	40.0	0.3049	3442	101	1384	YES
	A-E 504 T	42327	A	STATIC	2013	NO	32.9	41.0	0.4741	5056	116	1366	YES
	A-E 506 T	42346	A	STATIC	2015	NO	29.5	40.0	0.2162	3408	68.3	957	YES
	A-E 564 T	42336	A	STATIC	2013	NO	36.6	44.0	0.7527	6528	159	1349	YES
	A-E 566 T	42366	A	STATIC	2015	NO	31.7	41.0	0.3749	5249	81.4	936	YES
	A-E 636 T	42347	A	STATIC	2013	NO	33.8	43.0	0.410	6309	82	923	YES

* Best efficiency point.



DIMENSIONS

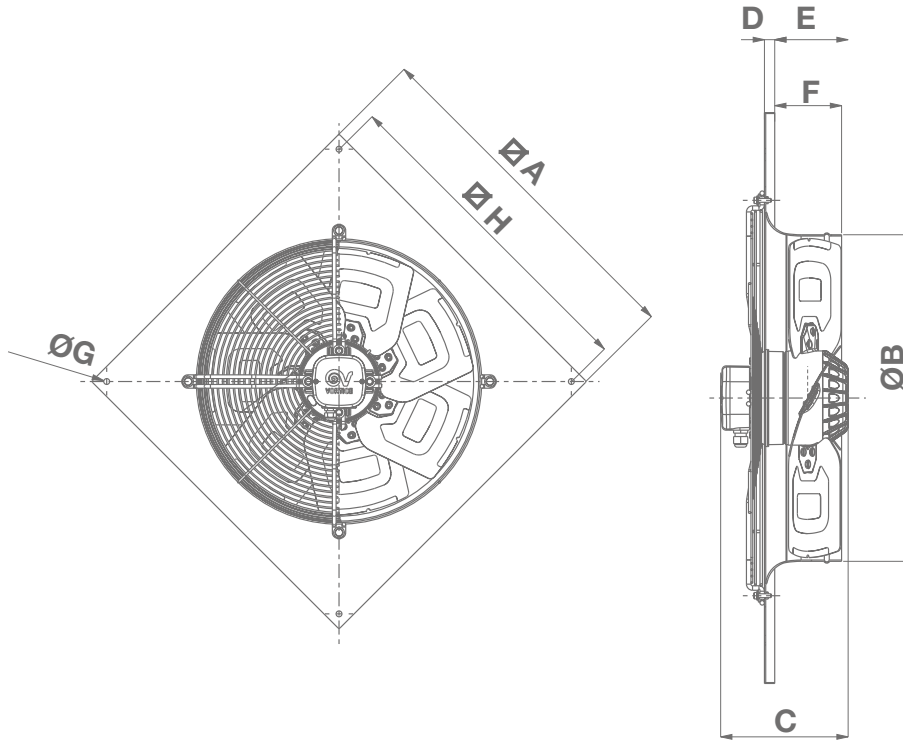

PRODUCTS	BLADES	ØA	ØB	C	D	E	F	G	ØH
A-E 252 M	5	320	264	149	10	-	82	8	280
A-E 254 M	5	320	264	149	10	-	82	8	280
A-E 254 T	5	320	264	149	10	-	82	8	280
A-E 304 M	5	380	316	151	10	-	84	8	330
A-E 304 T	5	380	316	151	10	-	84	8	330
A-E 354 M	5	450	361	155	12	85	74	9	380
A-E 354 T	5	450	366	155	12	85	74	9	380
A-E 404 M	4	510	406	200	12	108	88	12	430
A-E 454 M	4	630	455	206	15	100	85	12	530
A-E 506 M	7	630	508	218	16	134	105	11	530
A-E 506 T	4	630	508	198	16	114	105	11	530
A-E 566 M	5	725	563	248	16	161	105	11	675
A-E 566 T	5	725	563	218	16	131	105	11	675

Dimensions (mm)



INDUSTRIAL VENTILATION

VORTICEL A-E RANGE

DIMENSIONS

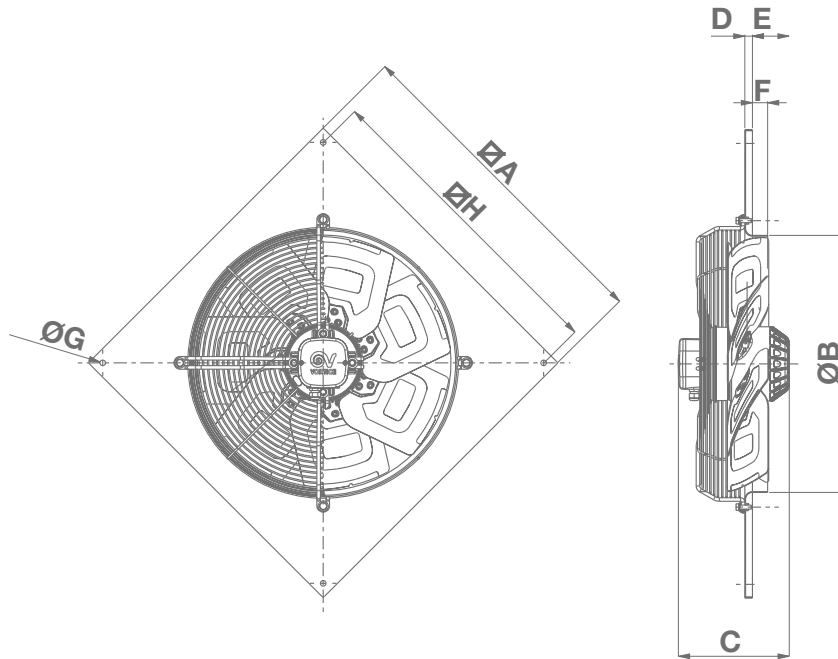

PRODUCTS	BLADES	ØA	ØB	C	D	E	F	G	ØH
A-E 404 T	4	510	406	207	15	67	30	12	430
A-E 454 T	4	630	455	207	15	67	30	12	530
A-E 504 M	4	630	507	218	15	72	30	11	530
A-E 504 T	4	630	507	198	15	52	30	11	530
A-E 564 T	4	725	563	218	15	67	30	11	675
A-E 636 T	4	805	638	218	15	68	45	11	750

Dimensions (mm)

PERFORMANCE CURVES

A-E 252 M

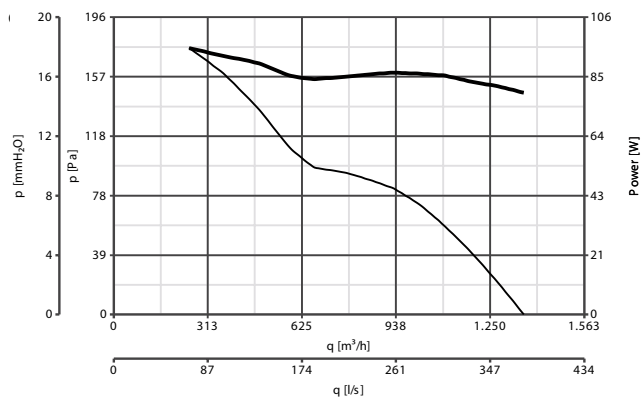

A-E 254 M

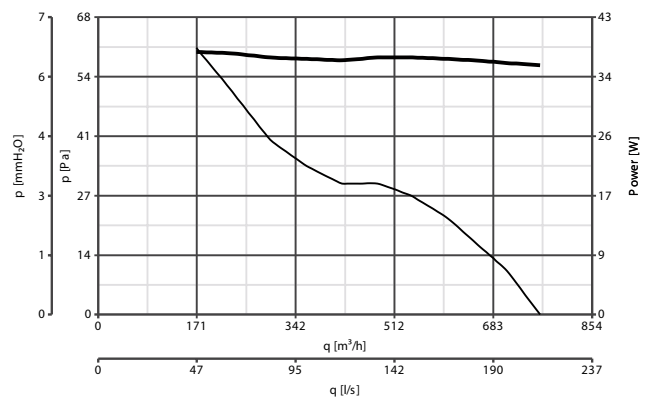

— Power consumption
— Delivery



PERFORMANCE CURVES

A-E 304 M

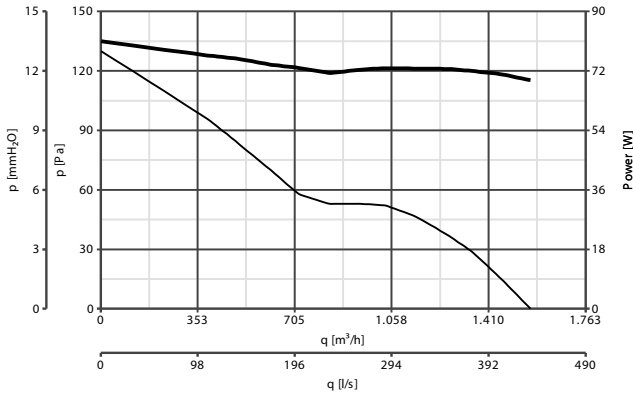

A-E 354 M

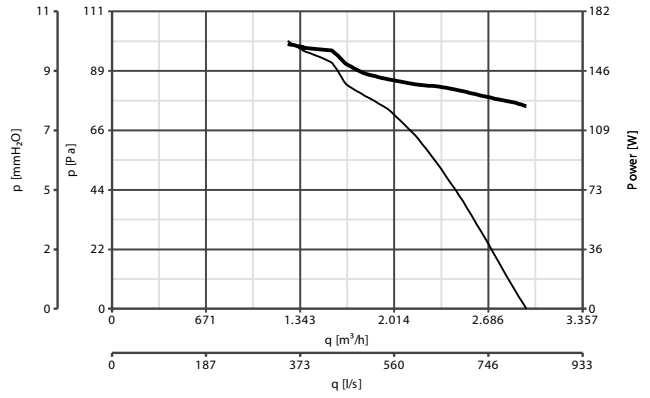

A-E 404 M

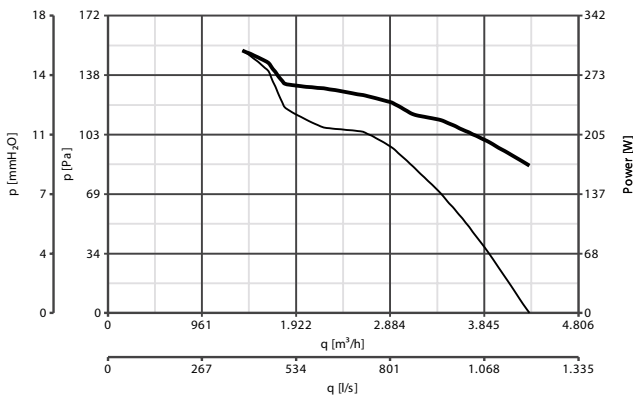

A-E 454 M

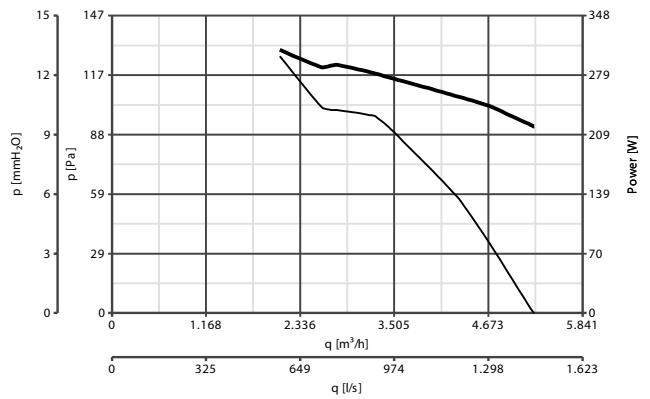

A-E 504 M

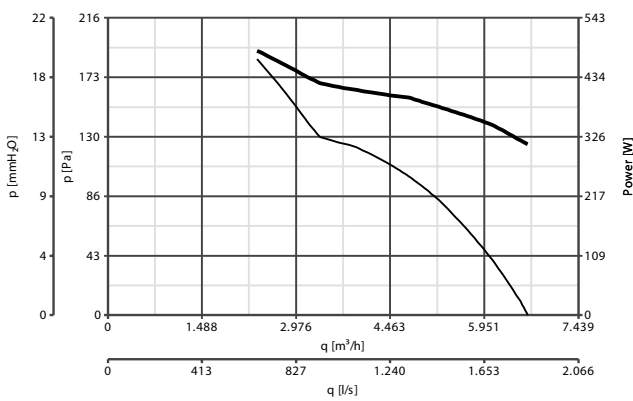

A-E 506 M

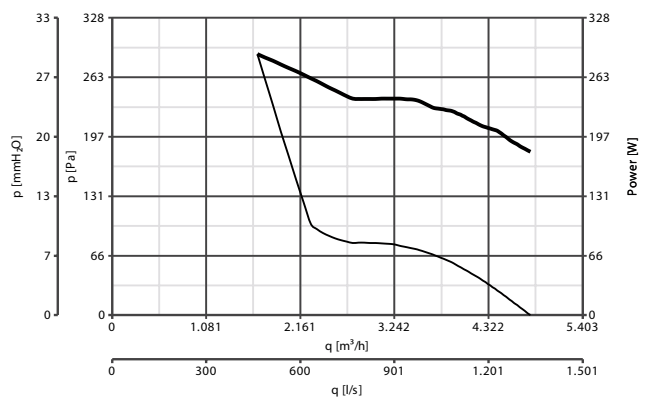

— Power consumption
— Delivery



PERFORMANCE CURVES

A-E 566 M

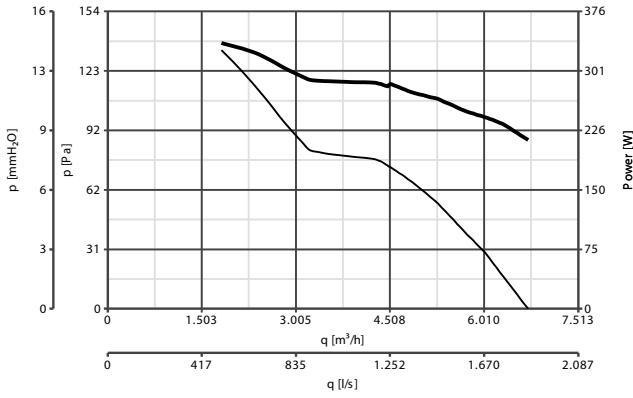

A-E 254 T

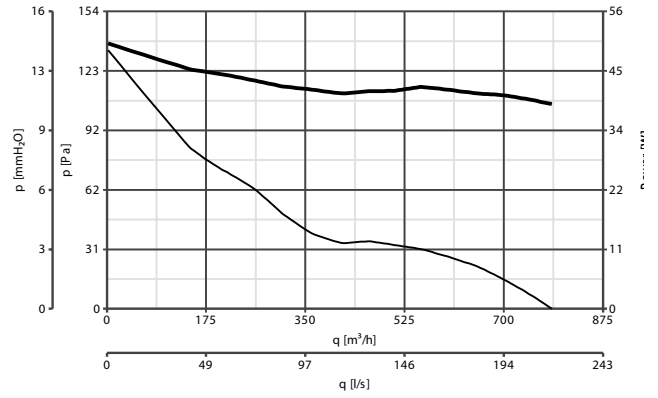

A-E 304 T

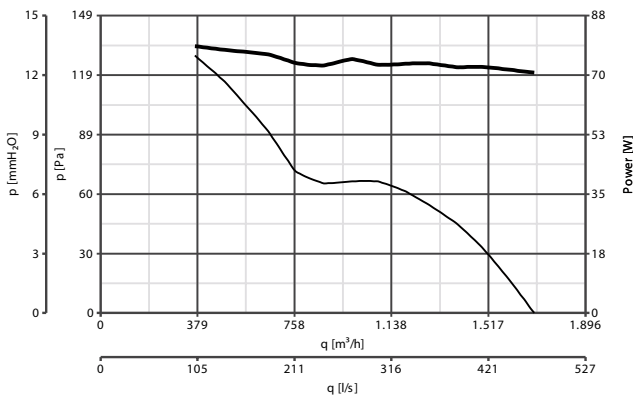

A-E 354 T

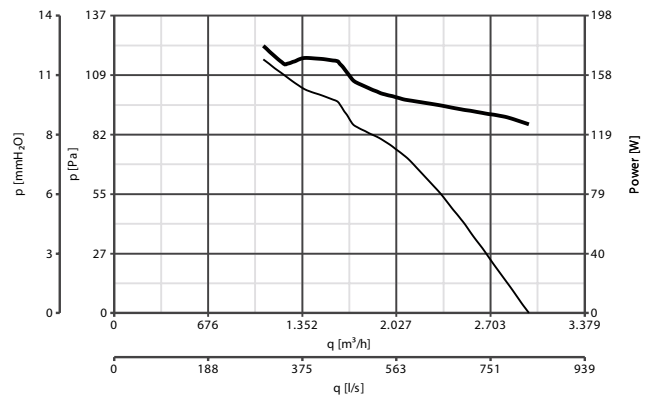

A-E 404 T

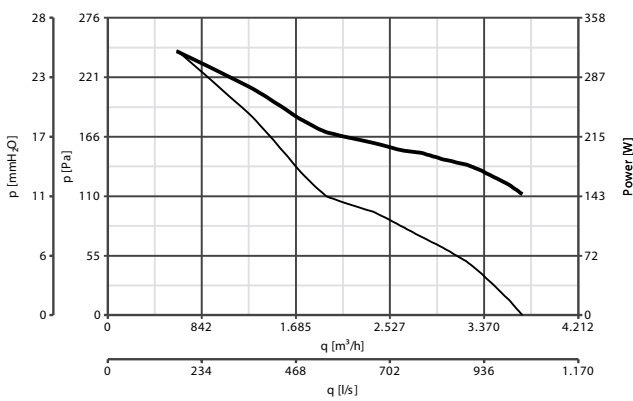

A-E 454 T

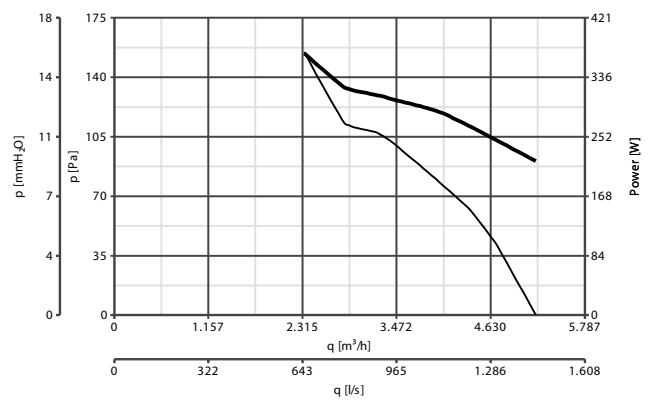

Power consumption
 Delivery



PERFORMANCE CURVES

A-E 504 T

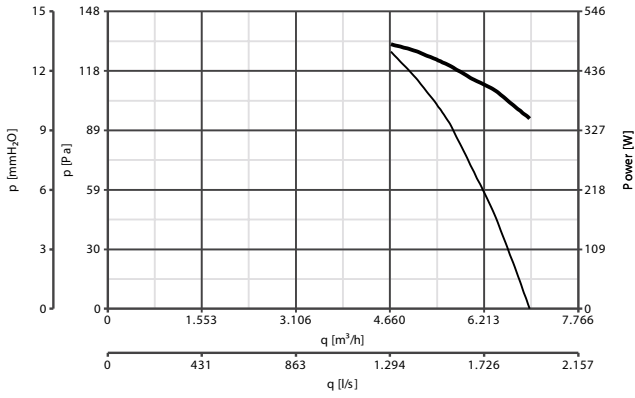

A-E 506 T

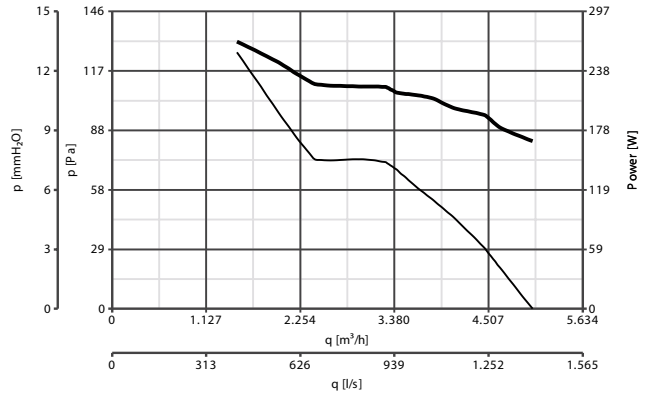

A-E 564 T

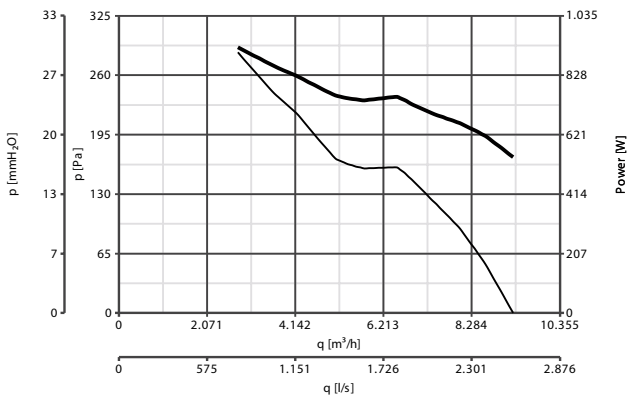

A-E 566 T

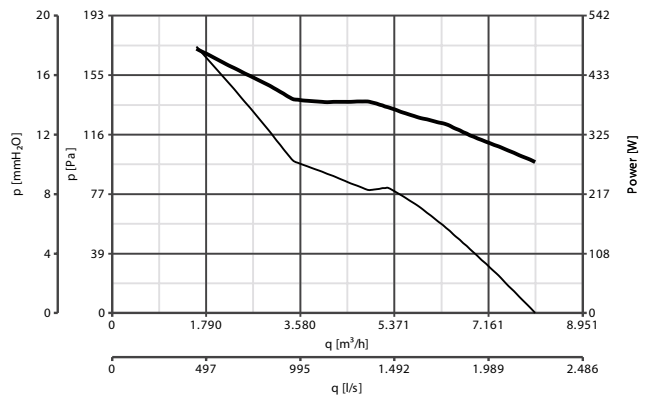

A-E 636 T

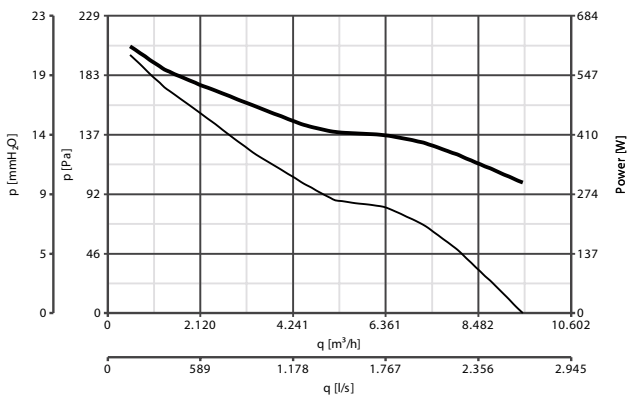



Power consumption
 Delivery







INDUSTRIAL VENTILATION

VORTICEL A-E RANGE

ACCESSORIES

MODELS	DESCRIPTION	CODE	PRODUCTS
	DPU - Spacer for panel installation	250	42207 - 42208 - 42357
		300	42216 - 42227
		350	42258 - 42259
		400	42260 - 42261
	PGR - Gravity shutter	250	42207 - 42208 - 42357
		300	42216 - 42227
		350	42258 - 42259
		400	42260 - 42261
		450/500	42307 - 42316 - 42337 - 42308 - 42327 - 42346 - 42347
	TRA - Frame with safety net	250	42207 - 42208 - 42357
		300	42216 - 42227
		350	42258 - 42259
		400	42260 - 42261
		400/500	42307 - 42316 - 42337 - 42308 - 42327 - 42346

CONTROLLERS

MODELS	DESCRIPTION	CODE	PRODUCTS
	IRM 30 - Three position single-phase speed controller	12921	42258 - 42260 - 42337 - 42356
	IRT 15 - Three position three-phase speed controller	12923	42227 - 42259 - 42261 - 42346 - 42657
	IRT 35 - Three-phase variable voltage drive	12924	42261 - 42308 - 42327 - 42336 - 42346 - 42347 - 42366
	IREM 3 - 3A Single-phase speed controller	12931	42207 - 42208 - 42216 - 42258 - 42260 - 42316 - 42337 - 42356
	C 1.5 - 1.5A Electronic speed controller	12966	42207 - 42208 - 42216 - 42258
	IREM INVERTER 4 M - Single-phase speed controller with inverter*	12815	42207 - 42208 - 42216 - 42258 - 42260 - 42307 - 42316 - 42337 - 42356
	IRET INVERTER 2.5 M - Three-phase speed controller with inverter*	12816	42357 - 42227 - 42259 - 42261 - 42308 - 42327 - 42346 - 42336 - 42366 - 42347
	POT - Potentiometer	12828	12815 - 12816

* To adjust a regulator with inverter, combine a 0-10V potentiometer as code 12828





VORTICEL MP RANGE

Medium-pressure plate axial fans

Wall-hung slim industrial medium-pressure axial fans, available with several diameters and in single and three phase versions; particularly suitable for the ventilation of business and industrial premises, such as offices, gyms, restaurants, discos, dye plants, industrial buildings

Key features

- High performance.
- Continuous operation high maximum environment temperature (70°C).
- Motors with high protection rating (IP55) from dusts and water.

Versions

- 19 models, in single and three phase version, with 2, 4 and 6 poles, with nominal diameter between 250 and 600 mm.

Technical features

- Moulded pickled phosphate-coated steel wall panels, painted with grey polyester powder for superior resistance against weathering over time and with hammered finish.
- Accident prevention and anti-bird grilles in compliance with the ISO 13857 Standard, integrating the motor support function, realised in electro-welded steel rings and painted with black epoxy powder. Easy removal simplifies maintenance and cleaning of the fan.
- Asynchronous induction motors (standard size UMELEC B5), with shaft mounted ball bearings and with cooling fans for more effective dissipation of the heat.
- Wing profile impeller with overlapping blades designed to reduce sound levels derived from air turbulence. Non-deformable polypropylene (PP) blades with high resistance and high dimensional stability and die-cast aluminum hub.
- Wide continuous operation temperature range: - 15°C / + 70°C.
- Maximum operating temperature with hot fumes 70 ° C.
- Motors protection rating (IP55).
- Insulation class: I (earthing is required).

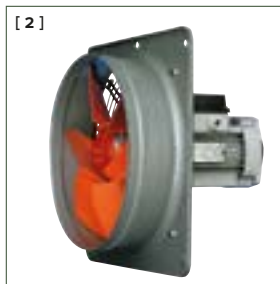
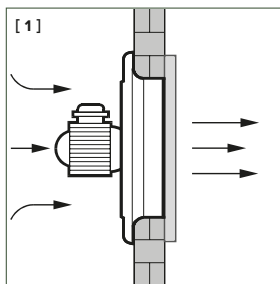

[1] These devices are suitable for applications that do not require the overcoming of load losses and for the extraction of non-dusty, non-acid or corrosive air.
[2] Side profile

Note

- The VORTICEL MP range fans are compliant with the ErP N. 327/2011/EU Reg: (only models 254 M, 304 M, 254 T and 304 T).
- The VORTICEL MP range fans are compatible with applications that envision significant head losses, such as those induced by discharge into ventilation ducts or by coupling to air filters. They are not suitable for handling streams characterised by significant concentrations of abrasive dusts or acid or corrosive substances.



TECHNICAL DATA

	PRODUCTS	CODE	V~50HZ	W	A	POLES	RPM	MAX AIRFLOW		MAX PRESSURE		Lp dB(A) * 3 m	°C** MAX	KG
								m³/h	l/s	mmH₂O	Pa			
SINGLE-PHASE	MP 252 M	42252	220-240	205-230	1.00-1.00	2	2800	2000	556	41	402	70	70	6.1
	MP 254 M	42254	220-240	60-65	0.29-0.29	4	1400	1150	319	13W	127	53	70	6.1
	MP 302 M	42202	220-240	520-550	2.60-2.65	2	2800	3500	972	60	588	75	70	9.4
	MP 304 M	42204	220-240	110-110	0.55-0.55	4	1400	2200	611	13	127	59	70	6.9
	MP 354 M	42214	220-240	240-270	1.15-1.18	4	1400	3150	875	18	177	64	70	10.2
	MP 404 M	42224	220-240	300-340	1.40-1.45	4	1400	4300	1194,4	13,7	134	66	70	11.2
THREE-PHASE	MP 254 T	42354	220/380 240/415	60 65	0.35/0.20 0.35/0.20	4	1400	1150	319	12	118	53	70	6.1
	MP 302 T	42302	220/380 240/415	540 560	2.10/1.20 2.25/1.30	2	2800	3500	972	65	638	75	70	9.4
	MP 304 T	42304	220/380 240/415	110 110	0.24/0.24 0.41/0.41	4	1400	2040	566,7	15	147	59	70	6.9
	MP 354 T	42314	220/380 240/415	185 210	0.62/0.36 0.64/0.37	4	1400	3150	875	18,4	180	64	70	10.2
	MP 404 T	42324	220/380 240/415	295 330	0.98/0.57 1.00/0.59	4	1400	4350	1208	18	177	66	70	11.2
	MP 454 T	42335	220/380 240/415	730 780	3.00/1.75 3.00/1.75	4	1400	6800	1889	34,6	339	66,5	70	18.5
	MP 504 T	42344	220/380 240/415	1100 1200	3.70/2.15 3.70/2.15	4	1400	8800	2444,4	37	363	74	70	19.2
	MP 506 T	42334	220/380 240/415	400 430	1.90/1.12 1.90/1.12	6	1000	6100	1694	17	167	63,5	70	19.3
	MP 604 T	42374	220/380 240/415	2200 2350	7,6/4,4 7,6/4,4	4	1400	14500	4028	39,6	388	79,5	70	28.1
	MP 606 T	42364	220/380 240/415	730 760	3,20/1,90 3,20/1,90	6	1000	10000	2778	18	177	68,5	70	28.2

*Sound pressure level measured at 1 and 3 m in free field conditions in accordance with standard ISO 3741.

** Maximum continuous operating temperature of the product.



INDUSTRIAL VENTILATION

VORTICEL MP RANGE

DIMENSIONS

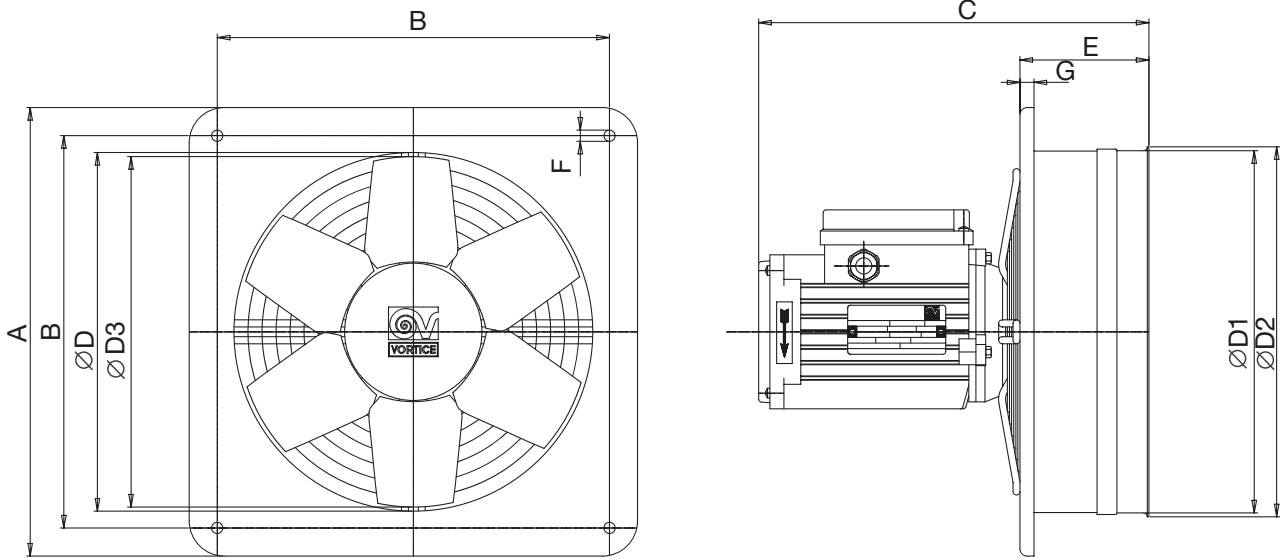

PRODUCTS	A	B	C	ØD	ØD1	ØD2	ØD3	E	ØF	G
MP 252	320	280	279	256	258.5	264	250	92	8	10
MP 254	320	280	279	256	258.5	264	250	92	8	10
MP 302	380	330	308	308	310.5	316	300	94	8	10
MP 304	380	330	279	308	310.5	316	300	94	8	10
MP 354	450	380	288	360	362.5	368	350	94	8	10
MP 404	510	430	308	410	412.5	418	400	114	12	15
MP 454	630	530	381	460	462.5	468	450	109	12	15
MP 504	630	530	381	510	512.5	518	500	109	12	15
MP 506	630	530	381	510	512.5	518	500	109	12	15
MP 604	760	630	430	610	612.5	618	600	124	12	15
MP 606	760	630	430	610	612.5	618	600	124	12	15

Dimensions (mm)



PERFORMANCE CURVES

MP 252 M

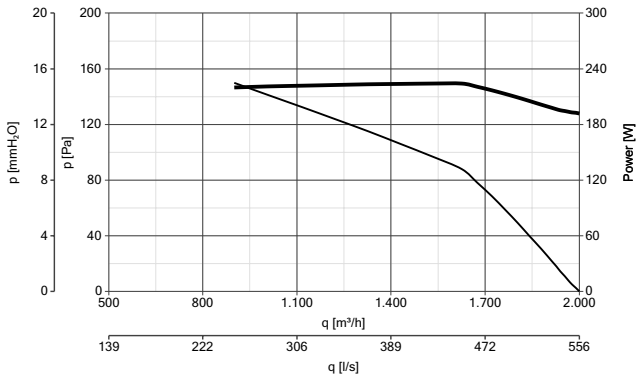

MP 254 M

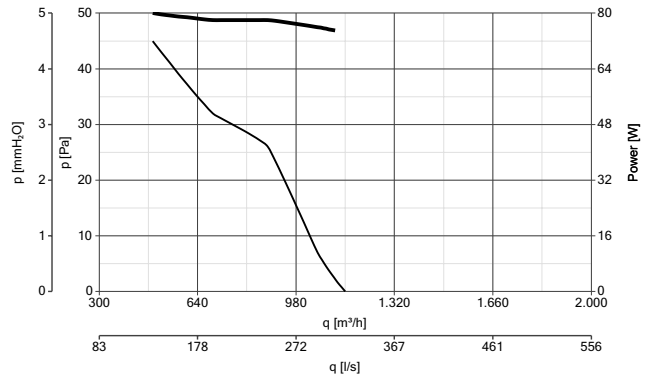

MP 302 M

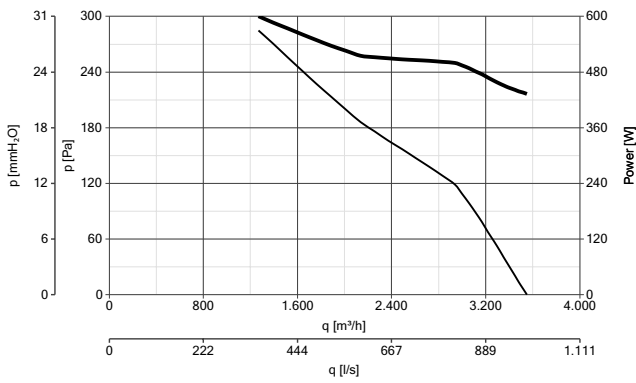

MP 304 M

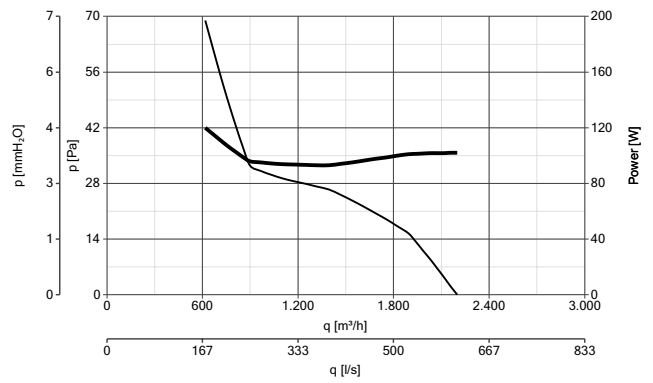

MP 354 M

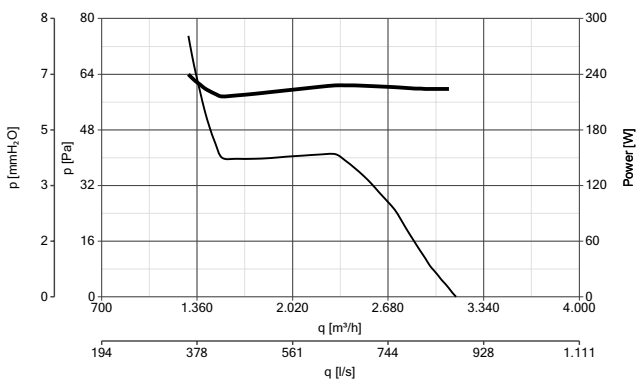

MP 404 M

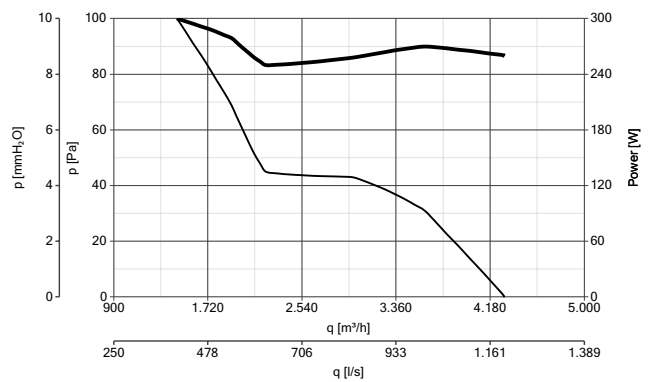

Power consumption
 Delivery



PERFORMANCE CURVES

MP 254 T

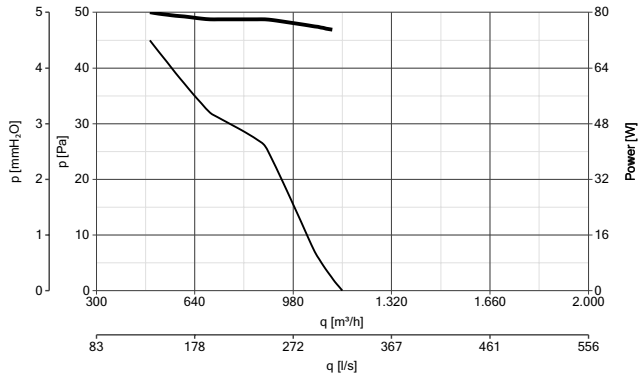

MP 302 T

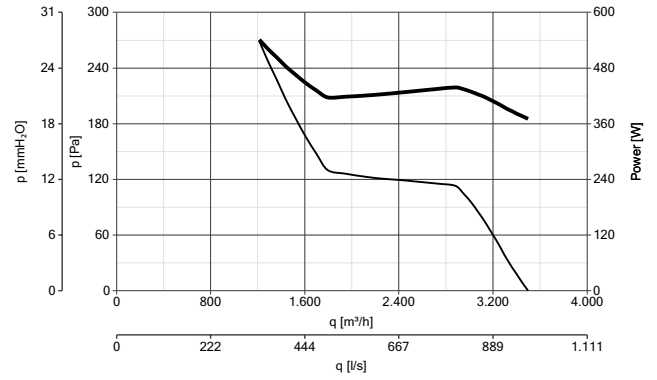

MP 304 T

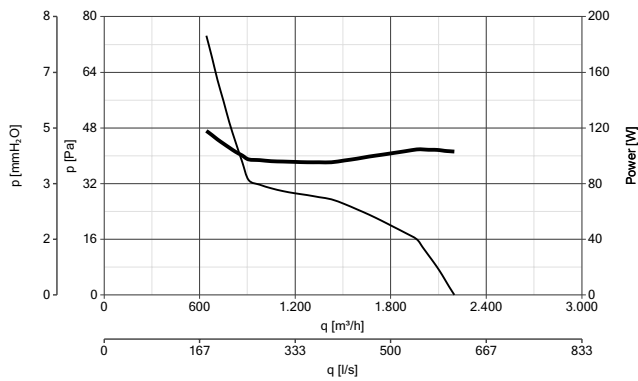

MP 354 T

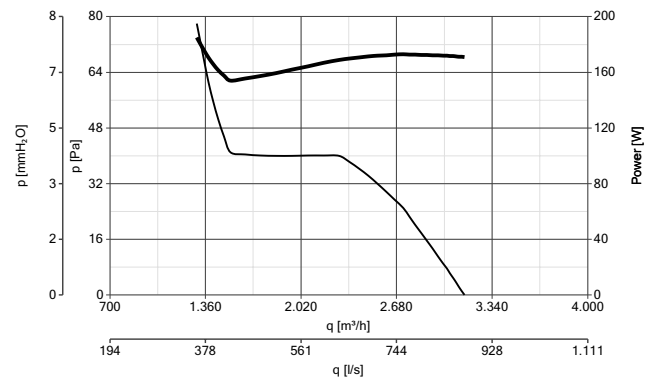

MP 404 T

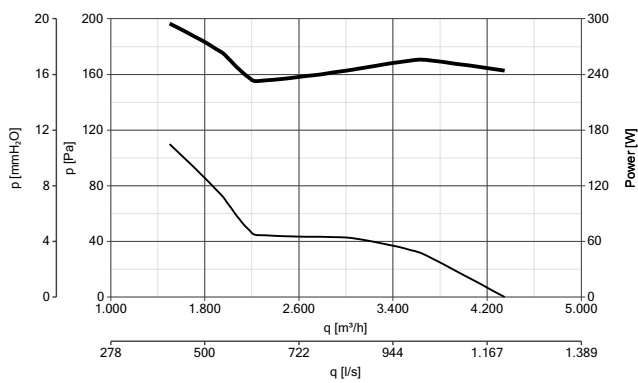

MP 454 T

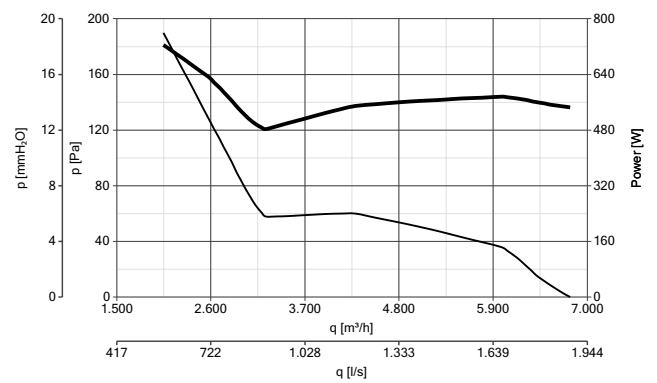

— Power consumption
— Delivery



PERFORMANCE CURVES

MP 504 T

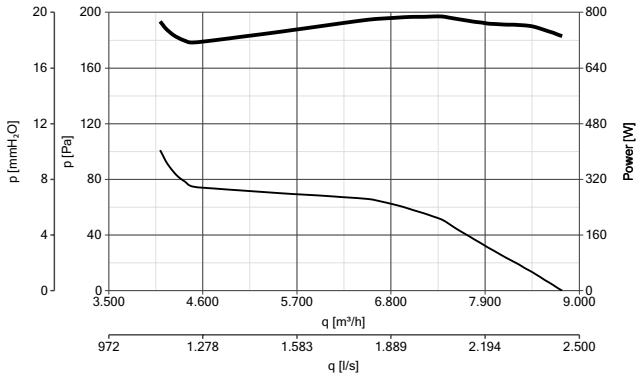

MP 506 T

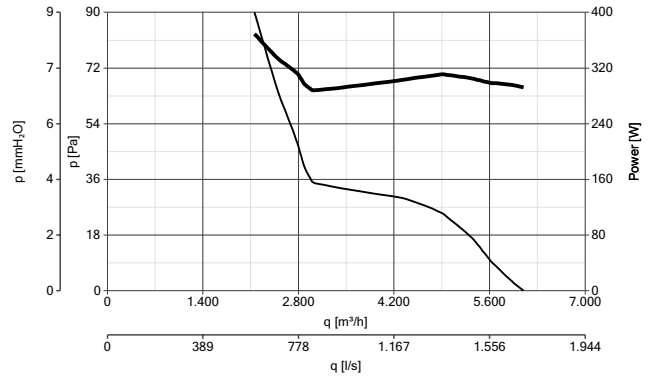

MP 604 T

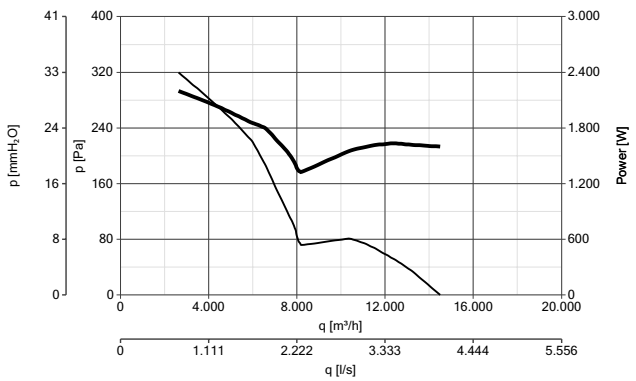

MP 606 T
MP 606 T

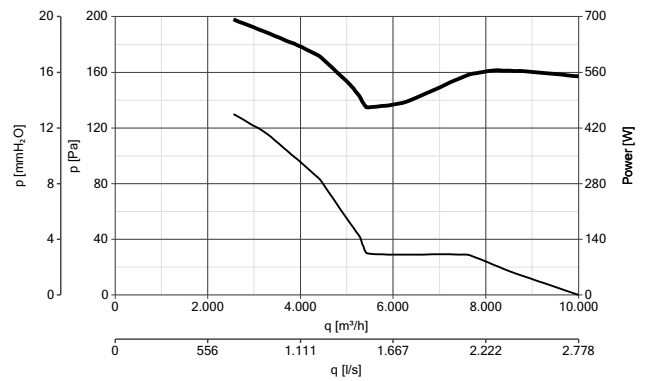



— Power consumption
— Delivery







INDUSTRIAL VENTILATION

VORTICEL MP RANGE

ACCESSORIES

MODELS	DESCRIPTION	CODE	PRODUCTS
	DPU - Spacer for panel installation	250	52151 42252 - 42254 - 42354
		300	52251 42202 - 42204 - 42302 - 42304
		350	52351 42214 - 42314
		400	52451 42224 - 42324
	PGR - Gravity shutter	250	50150 42252 - 42254 - 42354
		300	50250 42202 - 42204 - 42302 - 42304
		350	50350 42214 - 42314
		400	50450 42224 - 42324
	TRA - Protecion grille	250	51150 42202 - 42204 - 42302 - 42304
		300	51250 42204 - 42304
		350	51350 42214 - 42314
		400	51450 42224 - 42324
		450/500	51550 42334 - 42335 - 42344
		600	51650 42364 - 42374

CONTROLLERS

MODELS	DESCRIPTION	CODE	PRODUCTS
	IRM 30 - Three position single-phase speed controller	12921	42254 - 42354
	IRT 15 - Three position three-phase speed controller	12923	42304 - 42314 - 42324 - 42354
	IRT 35 - Three-phase variable voltage drive	12924	42302 - 42334 - 42335 - 42344 42364
	IREM 3 - 3A Single-phase speed controller	12931	42204 - 42214 - 42224 - 42252
	IREM 5 - 5A Single-phase speed controller *	12932	42204 - 42214 - 42224 - 42252
	IREM 9 - 9A Single-phase speed controller **	12933	42204 - 42214 - 42224 - 42252
	IREM INVERTER 4 M - Single-phase speed controller with inverter***	12815	42202 - 42304 - 42214 - 42224 42252 - 42254
	IRET INVERTER 2.5 M - Three-phase speed controller with inverter***	12816	42302 - 42304 - 42314 - 42324 - 42334 - 42354
	IRET INVERTER 5 M - Three-phase speed controller with inverter***	12817	42335 - 42344 - 42364
	POT - Potentiometer	12828	12815 - 12816

*Can control several fans up to a max 5A.

** Intended to simultaneously control appliance, up to a max 9A.

*** To adjust a regulator with inverter, combine a 0-10V potentiometer as code 12828

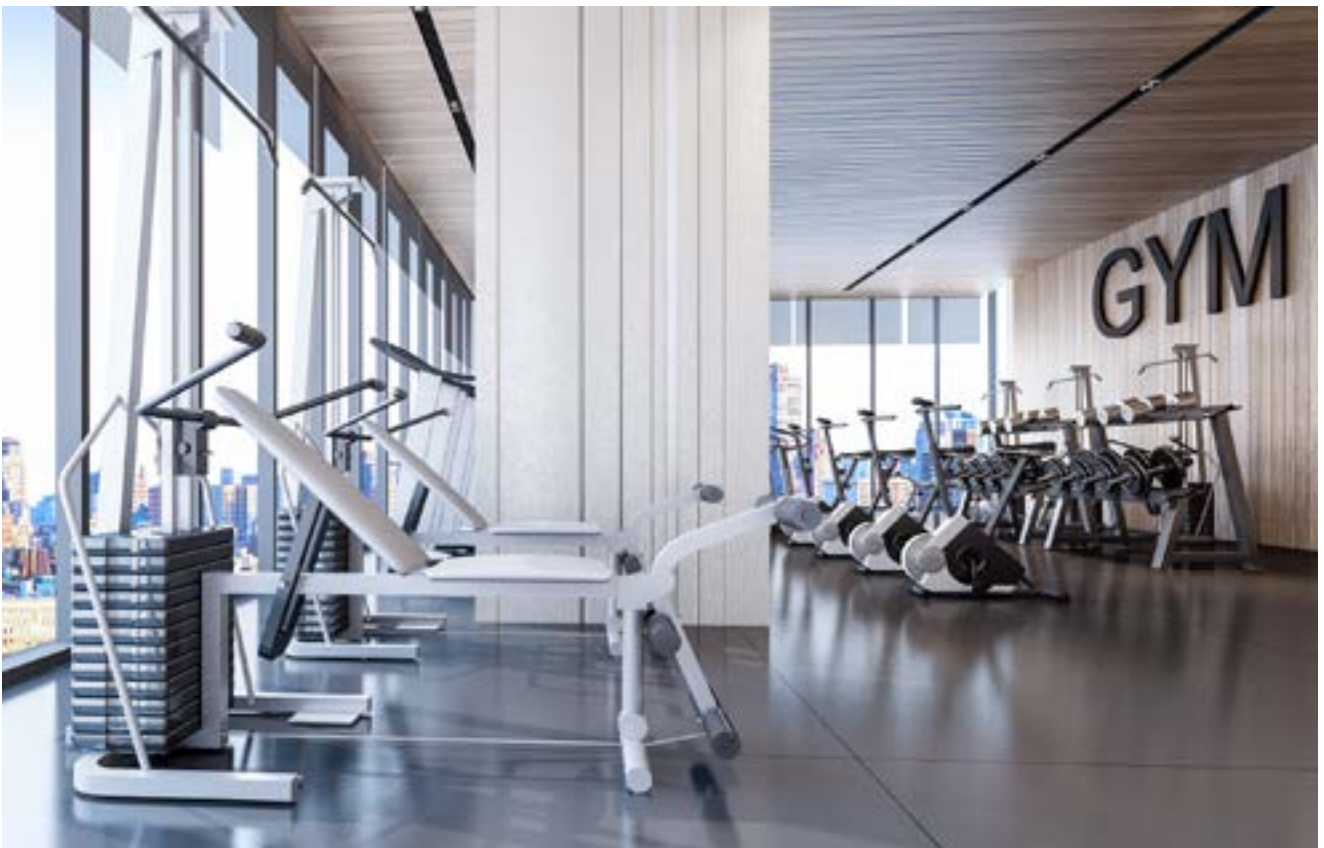



VORTICEL MPC-E RANGE

Medium-pressure long cased axial fans

Industrial ducted medium pressure axial fans, available in different diameters and single and three-phase versions, designed for the ventilation of commercial and industrial premises such as warehouses, greenhouses, agricultural premises and workshops, with free or duct discharge.

Key features

- Robust and weatherproof construction.
- Easy, quick set-up.
- Continuous operation at high maximum environmental temperature (70°C).

Versions

10 models, in single and three-phase version, with 2 and 4 poles, with a nominal diameter between 250 and 400 mm.

Technical features

- Case made of two pickled phosphated sheet steel flanged cylinders, calendered, welded and grey polyester powder-coated for higher long-term resistance against weathering and with hammered finish.
- Class F thermally protected asynchronous motors, with shafts turning on ball bearings with double sealing screen, characterized by high (IP55) degree of protection against dust and water, speed adjustable by Vortice controllers.
- Starting capacitors of the single-phase models comply with the EN 60252-1 Standard and are third-party certified.
- Impellers with 6-fin shaped blades fitted on grooved hubs in die-cast aluminium, dynamically balanced (UNI ISO 1940, Class 6.3), moulded in plastic resin loaded with glass fibres to combine dimensional stability, strength and resistance to aggressive agents

Note

- The fans of the VORTICEL MPC-E range comply with Reg. ErP No. 327/2011/UE.
- The fans of the VORTICEL MPC-E range are compatible with applications that envision high pressure drops, such as those induced by discharge into ventilation ducts or by coupling to air filters. They are not suitable for handling flows characterized by significant concentrations of abrasive powders or acid or corrosive substances.

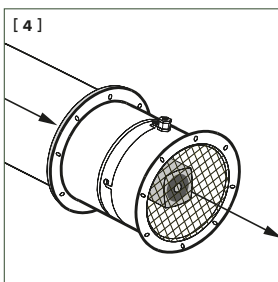
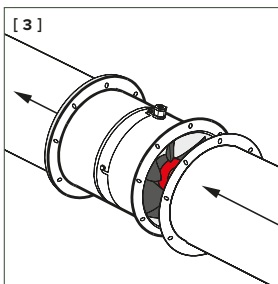
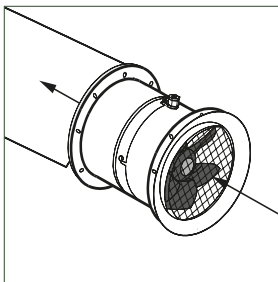

[1] Robust construction. [2] [3] [4] These devices can be applied with exhaust in the ventilation duct combined with filters used in all installations where there are pressure drops. The ventilated air must not be dusty, acidic or corrosive.





TECHNICAL DATA

	PRODUCTS	CODE	V~50HZ	W	A	POLES	RPM	MAX AIRFLOW		MAX PRESSURE		LW dB(A)	Lp dB(A)* 3 m	MAX °C**	KG
								m³/h	l/s	mmH₂O	Pa				
SINGLE-PHASE	MPC-E 254 M	42263	230	70	0.32	4	1460	1180	328	9.0	82	45.8	25.3	70	8.2
	MPC-E 302 M	42209	230	375	1.80	2	2940	2850	792	60.0	588	79.9	59.4	70	12.3
	MPC-E 304 M	42210	230	110	0.50	4	1390	2160	600	10.1	99	55.3	34.8	70	10.2
	MPC-E 354 M	42217	230	152	0.70	4	1450	3150	875	17.2	169	57.3	36.8	70	13.4
	MPC-E 404 M	42228	230	272	1.30	4	1440	4800	1333	18.7	183	68.6	48.1	70	14.0
THREE-PHASE	MPC-E 254 T	42359	400	60	0.21	4	1460	1210	336	8.2	80	45.8	25.3	70	8.2
	MPC-E 302 T	42309	400	360	1.00	2	2940	2900	805	60.0	588	79.2	58.7	70	12.3
	MPC-E 304 T	42310	400	107	0.24	4	1400	2250	625	10.4	102	55.3	34.8	70	10.2
	MPC-E 354 T	42317	400	155	0.30	4	1425	3550	986	15.9	156	66.7	46.2	70	13.4
	MPC-E 404 T	42328	400	225	0.40	4	1365	4700	1305	16.5	162	67.4	46.9	70	14.0

*Sound pressure level measured at 3 m in free field conditions in accordance with standard ISO 3741.

** Maximum continuous operating temperature of the product.

ERP DATA DIRECTIVE N° 327/2011/UE

	PRODUCTS	CODE	MEASUREMENT CAT.	EFFICIENCY CAT.	YEAR OF CONSTRUCTION	VARIABLE DRIVE	η	N.	kW Pe	m³/h q	BEP*		RPM	Spec. ratio <1.04
											Pa p	RPM		
SINGLE-PHASE	MPC-E 302 M	42209	C	STATIC	2015	NO	31.2	40.4	0.35	2080	186	2930	YES	
	MPC-E 354 M	42217	C	STATIC	2015	NO	29.9	41.5	0.15	2086	76	1450	YES	
	MPC-E 404 M	42228	C	STATIC	2015	NO	30.5	40.4	0.27	3711	80	1435	YES	
THREE-PHASE	MPC-E 302 T	42309	C	STATIC	2015	NO	31.0	40.2	0.34	2072	179	2920	YES	
	MPC-E 354 T	42317	C	STATIC	2015	NO	29.4	40.8	0.15	2565	64	1415	YES	
	MPC-E 404 T	42328	C	STATIC	2015	NO	30.5	41.0	0.24	2886	78	1373	YES	

* Best efficiency point.



INDUSTRIAL VENTILATION

VORTICEL MPC-E RANGE

DIMENSIONS

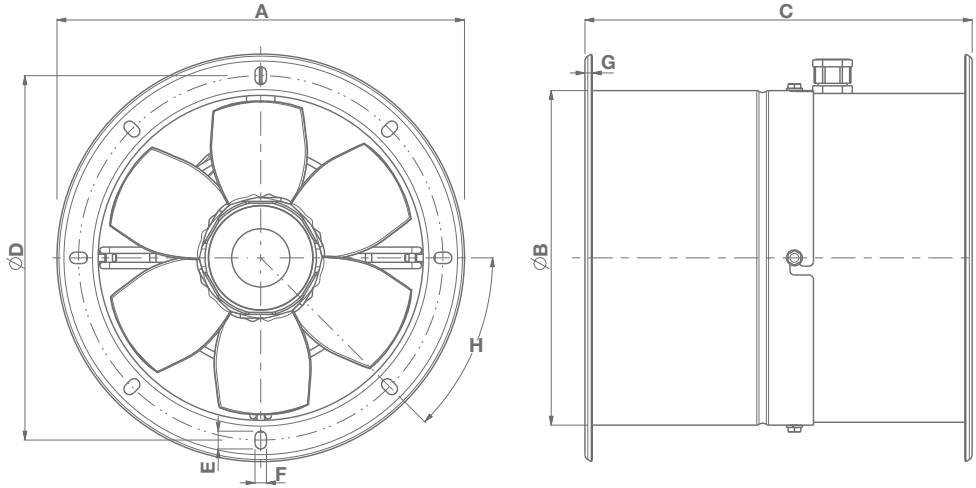

PRODUCTS	ØA	ØB	C	ØD	E	F	G	H
MPC-E 254	319	264	300	292	14	9	4	45°
MPC-E 302	393	316	330	366	14	9	4	45°
MPC-E 304	393	316	330	366	14	9	4	45°
MPC-E 354	432	368	330	405	14	9	4	45°
MPC-E 404	475	418	330	448	14	9	4	45°

Dimensions (mm)



PERFORMANCE CURVES

MPC-E 254 M

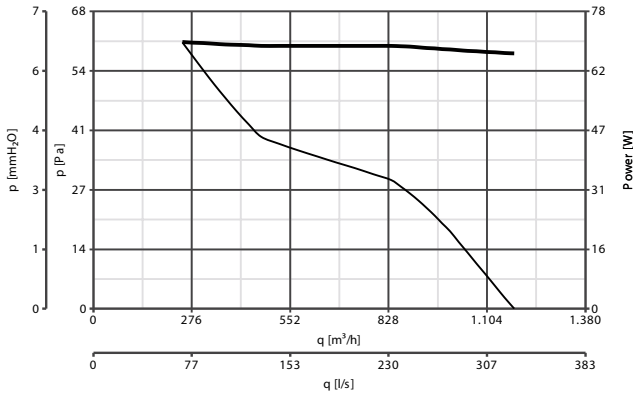

MPC-E 302 M

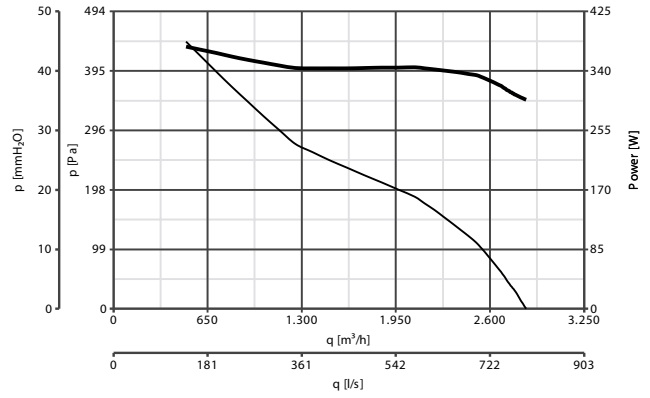

MPC-E 304 M

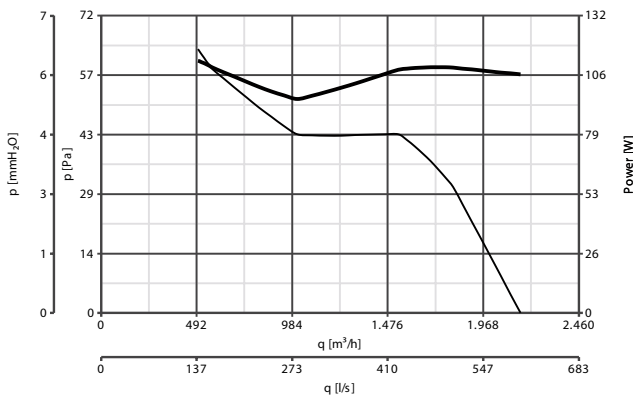

MPC-E 354 M

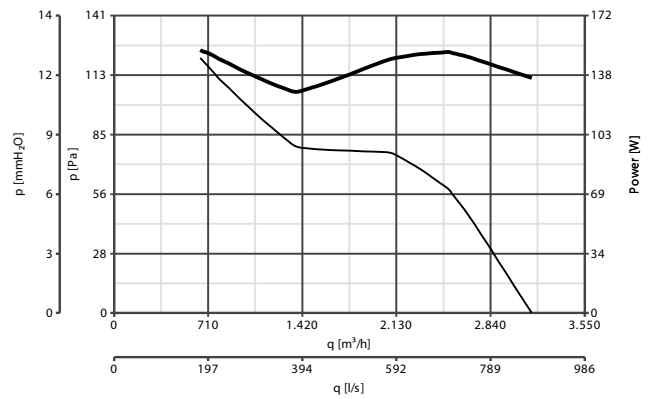

MPC-E 404 M

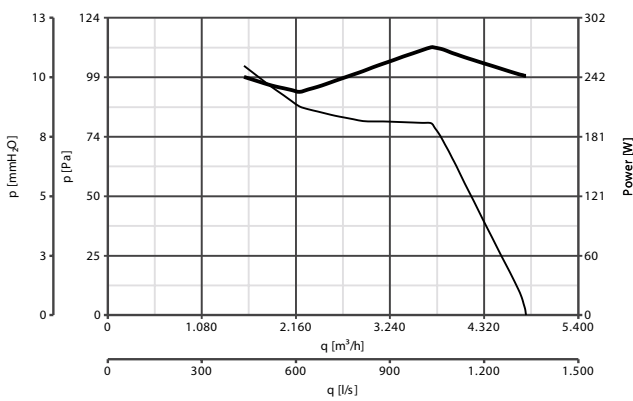

MPC-E 254 T

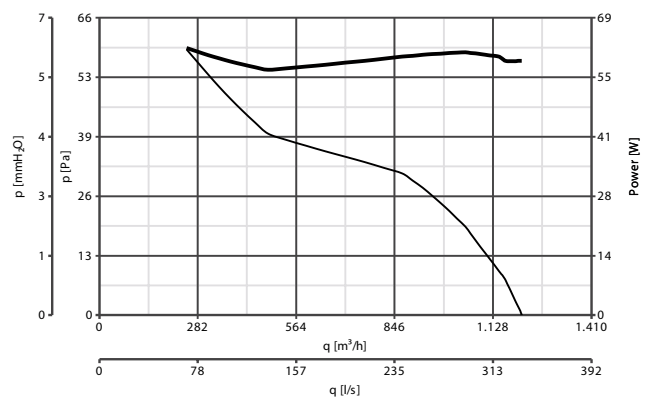

Power consumption
 Delivery



INDUSTRIAL VENTILATION

VORTICEL MPC-E RANGE

PERFORMANCE CURVES

MPC-E 302 T

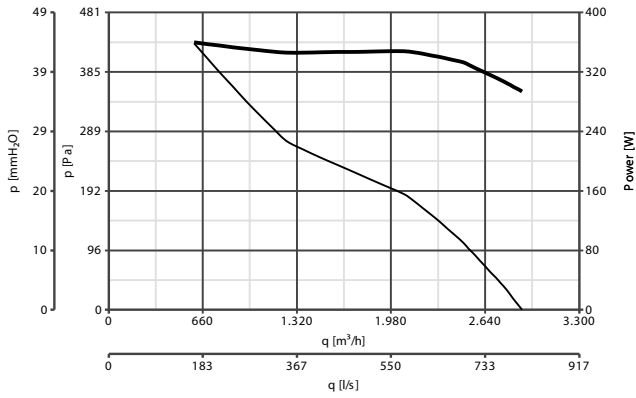

MPC-E 304 T

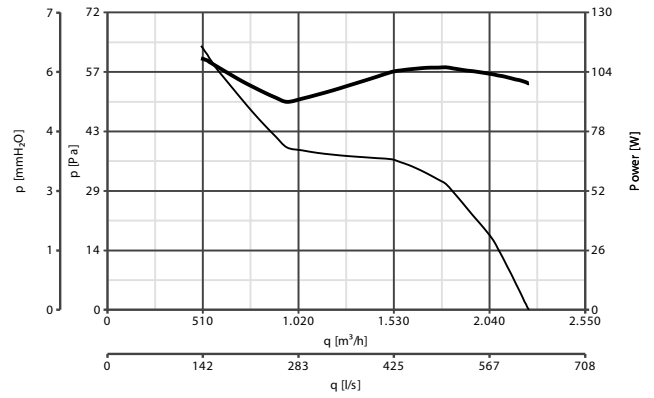

MPC-E 354 T

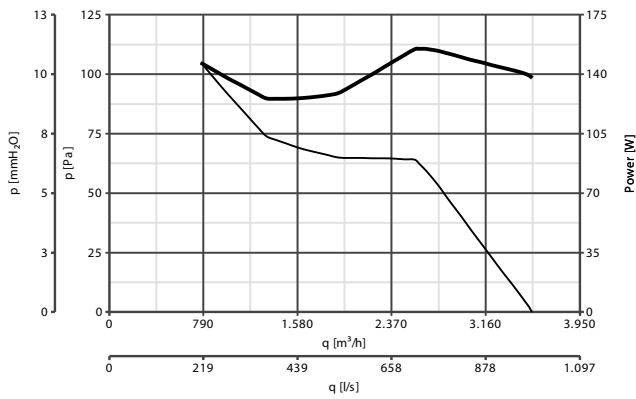



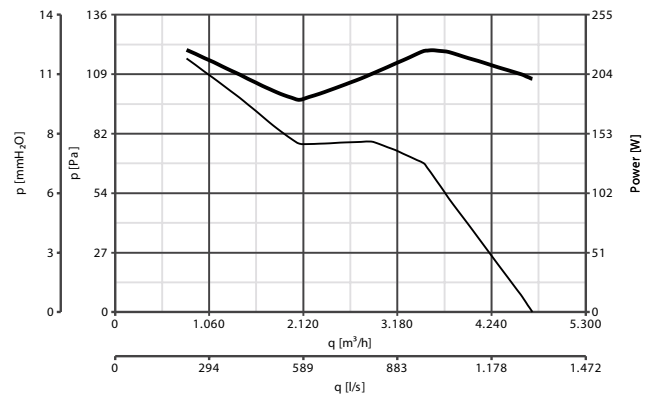

MPC-E 404 T





Power consumption
 Delivery



ACCESSORIES

MODELS	DESCRIPTION	CODE	PRODUCTS
	MPC BO - Suction connector	250	42263 - 42359
		300	42209 - 42210 - 42309 - 42310
		350	42217 - 42317
		400	42228 - 42328
	MPC RA - Flexible connector	250	42263 - 42359
		300	42209 - 42210 - 42309 - 42310
		350	42217 - 42317
		400	42228 - 42328
	MPC SU - Mounting feet	250	42263 - 42359
		300	42209 - 42210 - 42309 - 42310
		350	42217 - 42317
		400	42228 - 42328
	MPC FL - Coupling flange	250	42263 - 42359
		300	42209 - 42210 - 42309 - 42310
		350	42217 - 42317
		400	42228 - 42328
	MPC RP - Protection grille	250	42263 - 42359
		300	42209 - 42210 - 42309 - 42310
		350	42217 - 42317
		400	42228 - 42328

CONTROLLERS

MODELS	DESCRIPTION	CODE	PRODUCTS
	IRM 30 - Three position single-phase speed controller	12921	42263 - 42210
	IRM 40 - Three position single-phase speed controller	12922	42209 - 42217 - 42228
	IRT 15 - Three-phase variable voltage drive	12923	42359 - 42310 - 42317 - 42328
	IRT 35 - Three-phase variable voltage drive	12924	42309
	IREM 3 - 3A Single-phase speed controller	12931	42263 - 42210 - 42217 - 42228
	IREM 5 - 5A Single-phase speed controller *	12932	42209
	IRET 6 - 6A 5A Single-phase speed controller	12934	42359 - 42309 - 42310 - 42317 - 42328

*Can control several fans up to a max 5A.

** To adjust a regulator with inverter, combine a 0-10V potentiometer as code 12828



Efectis

Certification of conformity to EN 12101-3
standard issued by EPECTIS

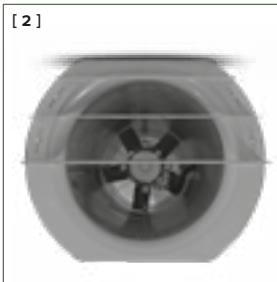
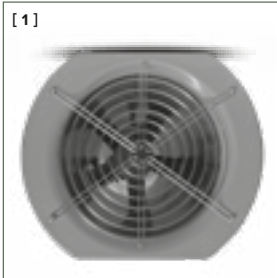

VORT JET A RANGE

Impulse axial jet fans



Axial impulse jet fans specifically designed for installation in underground car parks, guaranteeing the correct removal of exhaust gases and the effective and prompt extraction of high temperature fumes and the simultaneous creation of suitable escape routes for occupants in the event of fire.

There are many benefits of installing this type of appliance, which can be summarised as:

- High efficacy: the area of fire and smoke propagation is limited in view of its rapid removal.
- Easy and economic installation, in virtue of the absence of piping and ducts.
- Reduced consumption, up to 40% lower with respect to traditional ventilation systems, thanks to no pressure drops that can be traced to the piping.
- Lower electrical plant costs, given the possibility of using smaller and less expensive emergency generators.
- Easy maintenance.
- Flexible installation, thanks to proportionally reduced clearance.
- Maximised use of car park volumes, given the absence of cumbersome ducts.

Key features

- Thanks to the double speed motors, it is possible to combine ventilation mode operation, to guarantee suitable ventilation in car parks, to Fire Safety mode, with the action of the appropriately positioned MPC ED and MPC HP fans, appropriately positioned in the car park for the extraction of fumes and the simultaneous contribution of non-polluted air in correspondence with escape routes.
- Possibility of guaranteeing car park safety in the event of fire by minimising the number of units installed, thanks to the possibility of inverting the direction of the flow induced (Reversible R versions).
- Possibility of installation even in car parks with low ceilings, frequently found in cities, thanks to the availability of reduced diameter models.
- Completeness of the solution proposed, which is not limited simply to fans, but which also includes an extensive catalogue of accessories (alarm control units, sensors, shutters, etc.) accompanying the system, with the added value of support system design service, offered as an optional.

Versions

- 8 models, different based on the dimensions, functions and performance offered.



Technical features

- Galvanised sheet steel construction.
- Mono or bi-directional axial fans (R models), made of impellers with nominal diameters of 315, 355 and 400 mm, with die-cast aluminium airfoil blades, designed to optimise aeraulic efficiency, reduce the formation of vortices and thus contain consumption and noise emissions. Double speed, three-phase induction motors, with shafts turning on ball bearings (Dahlander system).
- Galvanised sheet steel deflectors mounted on the extraction side on unidirectional models. The deflectors are present at both ends on the reversible models (R).
- Galvanised steel grille on the delivery side.
- Galvanised steel sheet brackets for ceiling installation, supplied as standard with the product.
- Galvanised steel sheet oval end silencers, to contain clearance. Designed to guarantee correct laminar flow of the air handled. Rock wool sound-proofing lining with density 80 kg/m3.
- Electrical junction box mounted outside the product, for easy access to correctly wire the product to the mains.

TECHNICAL DATA

PRODUCTS	CODE	DIAM. Ø (M)	V~50HZ	MOTOR POWER (KW)	A	POLES	FLOW RATE M³/H MIN/MAX	AIR SPEED (M/S)	LP DB(A) MIN/MAX @ 1 M	CLASS.	THRUST (N)	KG
VORT JET-A 315/2	45641	315	400	0.24	0.72	2/4	2250	16	48 66	F300-120	6	114
VORT JET-A 315/2 R*	45643			0.96	2.3		4500	8	49 67		24	115.2
VORT JET-A 355/2	45645	355	400	0.3	0.96	2/4	3500	20	53 70	F300-120	10	123.4
VORT JET-A 355/2 R*	45647			1.32	2.99		7000	10	54 71		45	124.6
VORT JET-A 400/2	45649	400	400	0.3	0.96	2/4	4100	18.2	50 63	F300-120	13	139.3
VORT JET-A 400/2 R*	45651			1.32	2.99		8200	9.3	52 64		50	140.5
VORT JET-A 400/2 S	45653	400	400	0.6	1.85	2/4	5000 10000	11.8 23.7	54 70	F300-120	21 85	148.3
VORT JET-A 400/2 S R*	45655			2.64	5.56		5325 10650	11.2 22.3	55 72		19 75	149.5

*Reversible models





INDUSTRIAL VENTILATION

VORT JET A RANGE

DIMENSIONS

VORT JET-A RANGE

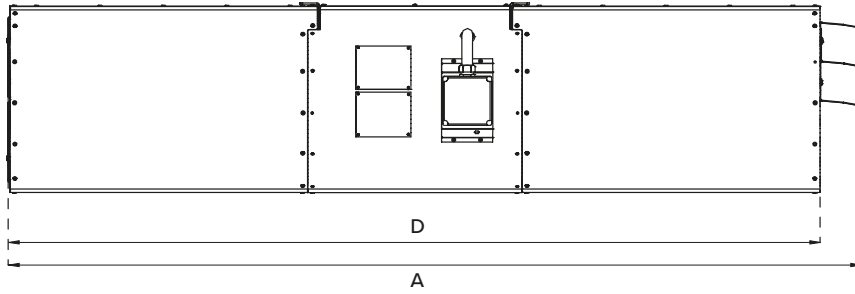

VORT JET-A R RANGE

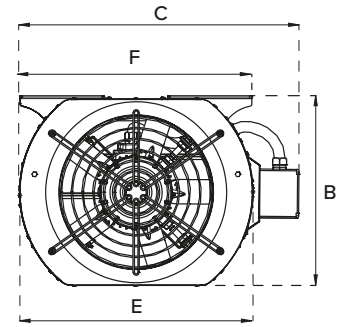
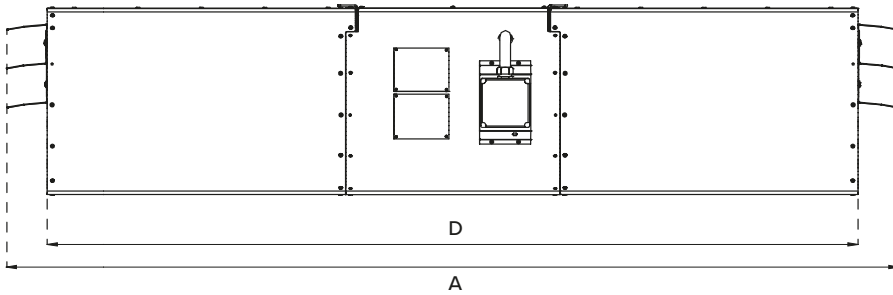



PRODUCTS	A	B	C	D	E	F
VORT JET-A 315	1747	389	572	1661	478	475
VORT JET-A 355	1907	444	613	1821	514	515
VORT JET-A 400	2087	488	659	2001	562	560
VORT JET-A 315/2 R	1827	389	572	1661	478	475
VORT JET-A 355/2 R	1984	444	613	1821	514	515
VORT JET-A 400/2 R	2167	488	659	2001	562	560

Dimensions (mm)



ACCESSORIES

MODELS	DESCRIPTION	CODE	PRODUCTS
	<p>SRM - Galvanized steel sheet motorised rectangular dampers for wall installation.</p> <p>The dampers are available in many heights, varying in steps of 200 mm, equal to the height of the individual fin, up to a maximum of 2000 mm. They are also available in various lengths, in the range of 200 mm and 2000 mm in steps of 50 mm.</p>		
		Ø 400	21438 SCM-400
		Ø 450	21439 SCM-450
		Ø 500	21440 SCM-500
		Ø560	21441 SCM-560
		Ø 630	21442 SCM-630
	<p>SCM - Galvanized steel sheet motorised circular dampers for installation on walls and coupled with axial fans.</p>	Ø 710	21443 SCM-710
		Ø 800	21444 SCM-800
		Ø 900	21445 SCM-900
		Ø 1000	21446 SCM-1000
		Ø 1120	21447 SCM-1120
		Ø 1250	21448 SCM-1250
		Ø 1400	21449 SCM-1400



SOFTWARE

Fan Selection

VORTICE Fan selection allows customers the ability to select the right fan starting from the duty point (flow rate and static pressure) in case MPC HP and MPC ED. The fan selection process has been designed for an easy use.

Fans can be selected from categories ranging from “MPC HP” to “MPC ED” to "VORT JET". These categories can be further broken down into diameter, prices and efficiency.

Once the product category/type are selected and the operating conditions are entered, the program searches across all available products to meet the selection criteria. Once a fan is selected, the user has the option to view

its technical data, its performance curve (if any) and its identification code, print the results or save the selection for future uses. In addition, he can create a drawing for the selected fan.

The software allows the user to specify a very detailed list of input data and parameters. It enables also a very detailed and specific selection, giving the user the possibility to specify a wide range of information for the fans to be selected. In a very quick and straightforward way, the software propose a set of fans that match the input criteria.

The image displays a collage of screenshots from the VORTICE Fan Selection software. At the top left is the 'SELECT FAN' search interface with various input fields for location, air flow, pressure, and fan speed. To its right is a table titled '32 Axial Fans Found' with columns for fan ID, name, and other specifications. Below these are several detailed views: a fan's physical appearance and specifications; a graph showing 'Required Point' and 'Actual Performance' curves; a detailed performance graph with 'Required Power', 'Required Efficiency', and 'Overall Efficiency' metrics; and a technical drawing of a fan with its dimensions and a list of specifications.





VORT JET A F400 RANGE

Impulse axial jet fans



Impulse jet fans (axial) specifically designed for installation in underground car parks, guaranteeing the correct removal of exhaust gases and, in the event of fire, the effective and prompt extraction of high temperature fumes and the simultaneous creation of suitable escape routes for the occupants.

There are many benefits from installing this type of appliance and they can be summarised as:

- High efficacy: the area of propagation of the fire smoke is limited in view of its rapid removal.
- Easy and economic installation, in virtue of the absence of piping and ducts.
- Reduced consumption, up to 40% lower with respect to traditional ventilation systems, thanks to no head losses that can be traced to the piping.
- Lower electric plant costs, given the possibility to use smaller and less expensive emergency generators.
- Easy maintenance.
- Flexible installation, thanks to proportionally reduced clearance.
- Maximised use of car park volumes, given the absence of cumbersome ducts.

Key features

- Thanks to the double speed motors, it is possible to combine operation in ventilation mode (to guarantee suitable ventilation in the car park) to that of Fire Safety (with the action of the appropriately positioned MPC ED and MPC HP fans), appropriately positioned in the car park, for the extraction of fumes and the simultaneous contribution of non-polluted air in correspondence with escape routes.
- Possibility of guaranteeing safety of the car park in the event of fire by minimising the number of units installed, thanks to the possibility of inverting the direction of the flow induced (Reversible R versions).
- Possibility of installation in car parks with low ceilings, frequent in the city, thanks to the availability of models with reduced diameter.
- Completeness of the solution proposed, which is not limited to the offer of the fans, but which is enriched with a wide catalogue of accessories (alarm control units, sensors, shutters, etc.) accompanying the system, and gives it value with the support service to the design of the system offered as an optional.

Versions

24 models, different in size, performance and functions.



Technical features

- Fire resistance certified F400/120.
- Mono or reversible (R) ducted axial fans, made up of impellers with nominal diameters of 315, 355 and 400 mm, with die-cast aluminium airfoil blades, studied to optimise aerodynamic efficiency, reduce the formation of vortices and thus contain consumption and noise emissions. Reinforced steel sheet enclosures.
- Class H, double speed, (Dahlander) three-phase motors with shafts mounted on ball bearings. All models are available in standard and enhanced version (S variants).
- Galvanised steel sheet circular end silencers, designed to guarantee correct laminar flow of the air handled. Rock wool sound-proofing lining.
- Steel sheet deflectors complete with grille in correspondence with the extraction side, to prevent damage to persons and prevent the intake of foreign bodies. Reversible models (R versions) mount a pair of deflectors.
- Brackets for ceiling installation, supplied as per standard with the product.
- Electric junction boxes mounted outside the product, easy to access for correct wiring of the product to the mains.





INDUSTRIAL VENTILATION

VORT JET A F400 RANGE

TECHNICAL DATA

PRODUCTS	CODE	DIAM. Ø (M)	V~50HZ	MOTOR POWER (KW)	A	POLES	FLOW RATE M ³ /H MIN/MAX	AIR SPEED (M/S)	LP DB(A) MIN/MAX @ 1 M	CLASS.	THRUST (N)	KG
VORT JET-A 315 F400	45612	315	230	0,55	2,36	2	4280	16,27	67	F400/120	23	91
			400		1,36							
VORT JET-A 315 R F400	45613	315	230	0,55	2,36	2	4140	16,27	65	F400/120	22	95
			400		1,36							
VORT JET-A 315/2 F400	45614	315	400	0,12	0,45	2	2140	8,14	51	F400/120	11,5	91
				0,55	1,47	4	4280	16,27	62		23	
VORT JET-A 315/2 R F400	45615	315	400	0,12	0,45	2	2070	7,84	49	F400/120	11	95
				0,55	1,47	4	4140	15,74	65		22	
VORT JET-A 315 S F400	45637	315	230	1,1	2,39	2	5140	19,54	70	F400/120	33	93
			400		4,14							
VORT JET-A 315 S R F400	45638	315	230	1,1	2,39	2	4500	17,11	68	F400/120	26	97
			400		4,14							
VORT JET-A 315/2 S F400	45639	315	400	1,1	0,59	2	2570	9,77	54	F400/120	16,5	93
				0,18	2,36	4	5140	19,54	70		33	
VORT JET-A 315/2 S R F400	45640	315	400	1,1	0,59	2	2465	6,54	52	F400/120	11	99
				0,18	2,36	4	4930	13,09	68		22	
VORT JET-A 355 F400	45616	355	230	0,55	1,36	2	4930	13,09	72	F400/120	22	99
			400		2,36							
VORT JET-A 355 R F400	45617	355	230	0,55	1,36	2	5190	13,78	70	F400/120	24	101
			400		2,36							
VORT JET-A 355/2 F400	45618	355	400	0,12	0,45	2	2465	6,54	56	F400/120	11	99
				0,55	1,47	4	4930	13,09	72		22	
VORT JET-A 355/2 R F400	45619	355	400	0,12	0,45	2	2595	6,89	54	F400/120	12	101
				0,55	1,47	4	5190	13,78	70		24	
VORT JET-A 355 S F400	45642	355	230	1,1	2,39	2	6480	17,2	70	F400/120	37	101
			400		4,14							
VORT JET-A 355 S R F400	45644	355	230	1,1	2,39	2	6400	16,99	68	F400/120	36	103
			400		4,14							
VORT JET-A 355/2 S F400	45646	355	400	0,18	0,59	2	3240	8,6	54	F400/120	18,5	101
				1,1	2,36	4	6480	17,2	70		37	
VORT JET-A 355/2 S R F400	45648	355	400	0,18	0,59	2	3200	8,5	52	F400/120	18	103
				1,1	2,36	4	6400	16,99	68		36	
VORT JET-A 400 F400	45633	400	230	1,1	2,39	2	8050	17,53	75	F400/120	47	121
			400		4,14							
VORT JET-A 400 R F400	45634	400	230	1,1	2,39	2	7740	16,86	73	F400/120	43	125
			400		4,14							
VORT JET-A 400 /2 F400	45635	400	400	0,18	0,59	2	4025	8,77	59	F400/120	23,5	121
				1,1	2,36	4	8050	17,53	75		47	
VORT JET-A 400 /2 R F400	45636	400	400	0,18	0,59	2	3870	8,43	57	F400/120	21,5	125
				1,1	2,36	4	7740	16,86	73		43	
VORT JET-A 400 S F400	45650	400	230	1,5	3,14	2	8850	19,27	77	F400/120	57	128
			400		5,83							
VORT JET-A 400 S R F400	45652	400	230	1,5	3,14	2	8890	18,92	75	F400/120	55	128
			400		5,83							
VORT JET-A 400/2 S F400	45654	400	400	0,37	0,37	2	4345	9,46	61	F400/120	27,5	128
				1,5	1,5	4	8690	18,92	77		55	
VORT JET-A 400 /2 S R F400	45656	400	400	0,37	0,37	2	4325	9,64	59	F400/120	28,5	128
				1,5	1,5	4	8850	19,27	75		57	



DIMENSIONS

VORT JET-A F400 Range

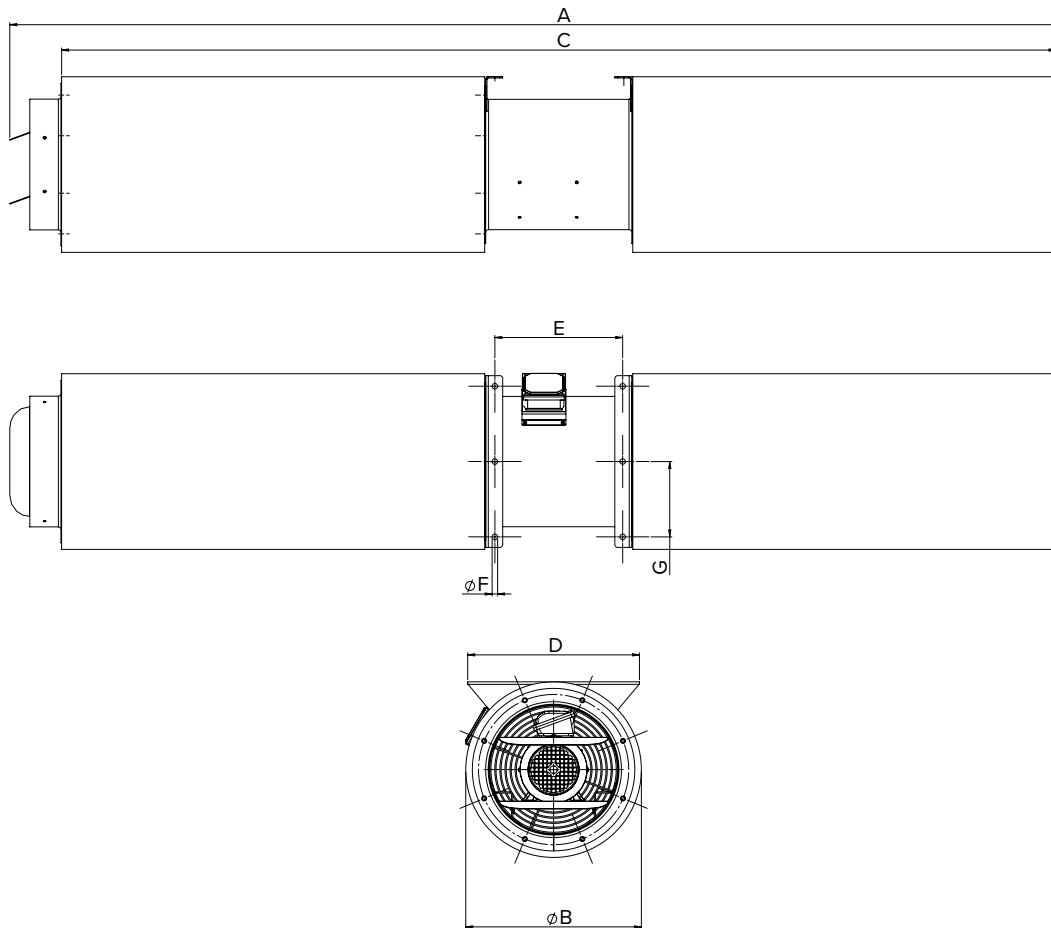

PRODUCT	A	B	C	D	E	F	G
VORT JET-A 315	2480	415	2350	406	302	13	356
VORT JET-A 355	2525	455	2395	461	347	13	411
VORT JET-A 400	2570	500	2440	506	392	13	456

Dimensions (mm)



INDUSTRIAL VENTILATION

VORT JET A F400 RANGE

DIMENSIONS

VORT JET-A R F400 Range

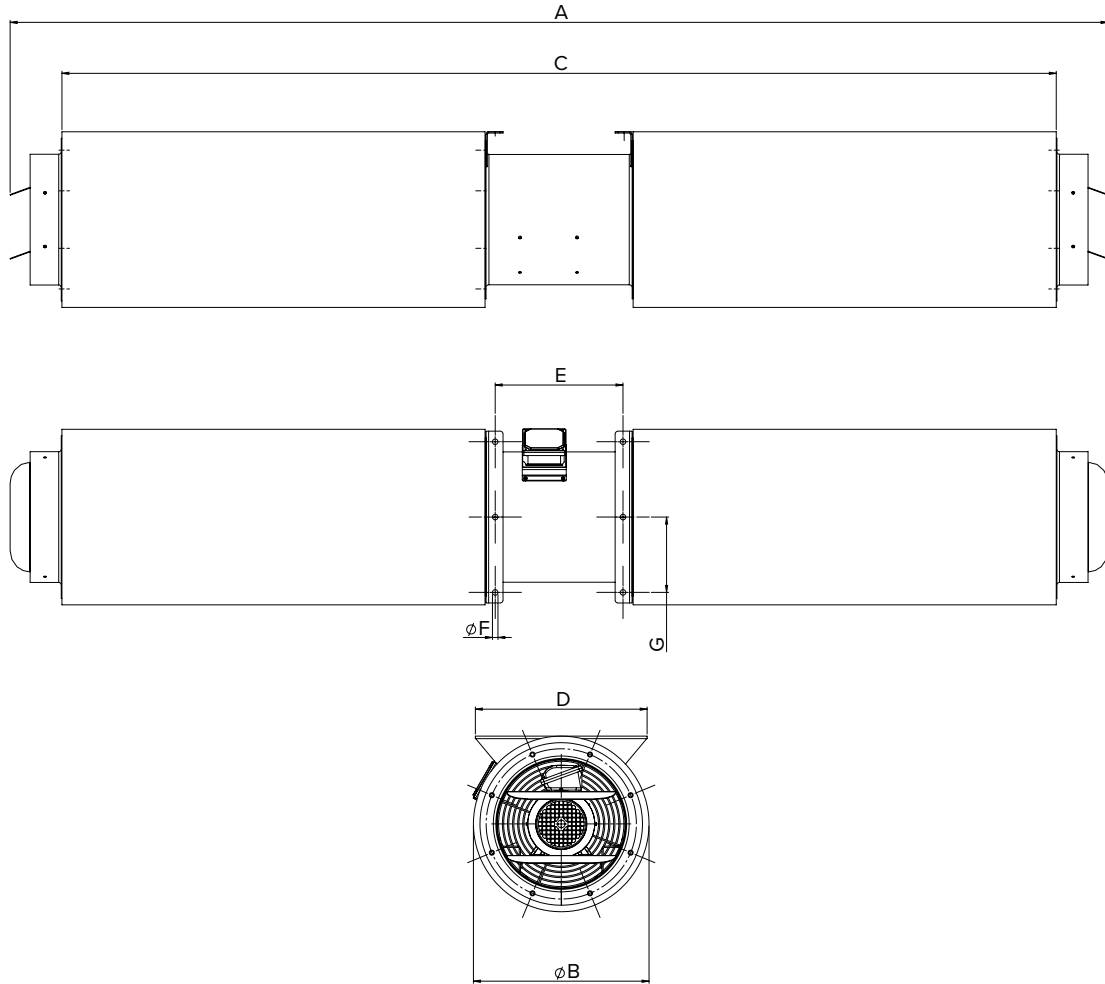

PRODUCT	A	B	C	D	E	F	G
VORT JET-A R 315	2594	415	2350	406	302	13	356
VORT JET-A R 355	2639	455	2395	461	347	13	411
VORT JET-A R 400	2684	500	2440	506	392	13	456

Dimensions (mm)



SOFTWARE



VORTICE Fan selection Pro is the latest development of the Vortice selection software.

All that you need to know about Vortice products is available in our free selection software at: vortice.com

With **Fan selection Pro**, powered by Vortice, it is possible to find the most suitable fan to the needs of an installation by introducing an airflow and pressure point, and/or using filters for fan, motor, turbine, blades, among many others. Quickly and easily you will find the product you need for your ventilation system and even make comparatives between different options that are listed to the search results.

After finding the desired product or products just click to get a technical report in PDF with all technical information: image, description, RRP, characteristic curve (with static pressure, dynamic pressure, total pressure, power consumption, performance and resistive curve, static, dynamic pressure, total pressure, absorbed power, performance, resistive curve, mechanical power, static and total efficiencies without motor and assembled), acoustic spectrum, dimensions drawing, wiring diagram, related accessories and related documentation (manuals, certificates, EC declaration of conformity, declaration of performance, etc.).

The latest improvement of **VORTICE Fan selection Pro** allows to make the optimal selection of the motor depending on the requested outy point.

Now **VORTICE Fan selection Pro** offers the possibility to select the most efficient fan for a specific installation.

More data shown with more types of curve:

- Mechanical power
- Absorbed power
- Static and total efficiencies without the engine and the assembled assembly (with the engine included, taking into account the efficiency of the engine depending on the factor of use thereof).

Not all **Vortice Fan selection Pro** users have the same privileges to access the information. Registration is required in order to have all options available. To learn everything the software offers you, register and access the program now for free.

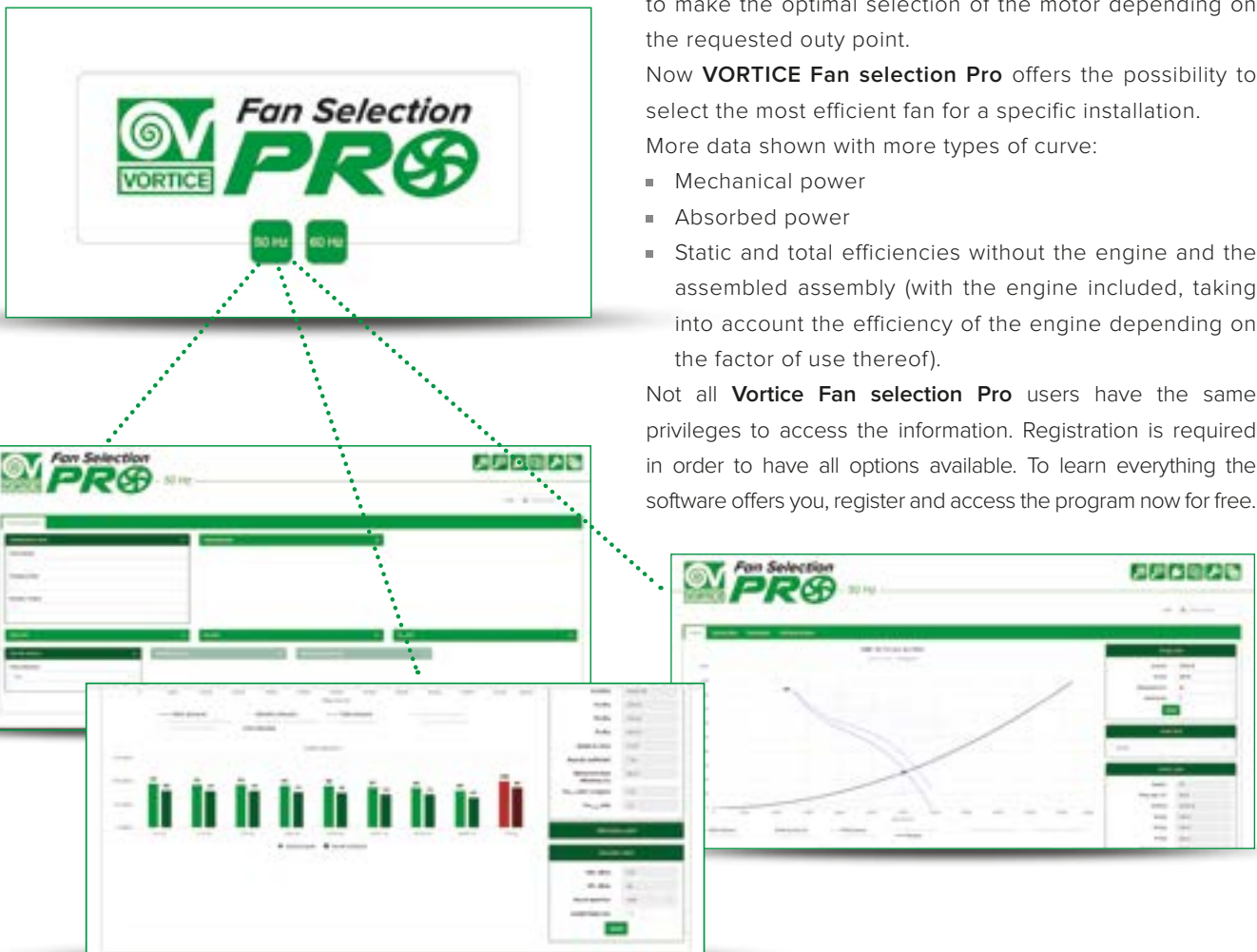



Efectis

Certification of conformity to EN 12101-3
standard issued by EFACTIS

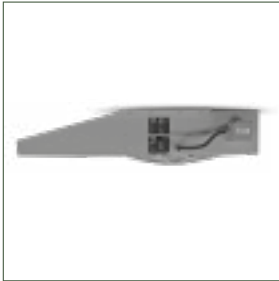

VORT JET R RANGE

Induction centrifugal jet fans



Induction jet fans (radial) specifically designed for installation in underground car parks, guaranteeing the correct removal of exhaust gases and, in the event of fire, the effective and prompt extraction of high temperature fumes and the simultaneous creation of suitable escape routes for the occupants.

There are many benefits from installing this type of appliance and they can be summarised as:

- High efficacy: the area of propagation of the fire smoke is limited in view of its rapid removal.
- Easy and economic installation, in virtue of the absence of piping and ducts.
- Reduced consumption, up to 40% lower with respect to traditional ventilation systems, thanks to no head losses that can be traced to the piping.
- Lower electric plant costs, given the possibility to use smaller and less expensive emergency generators.
- Easy maintenance.
- Flexible installation, thanks to proportionally reduced clearance.
- Maximised use of car park volumes, given the absence of cumbersome ducts.

Key features

- Thanks to the double speed motors, it is possible to combine operation in ventilation mode (to guarantee suitable ventilation in the car park) to that of Fire Safety (with the action of the appropriately positioned MPC ED and MPC HP fans), appropriately positioned in the car park, for the extraction of fumes and the simultaneous contribution of non-polluted air in correspondence with escape routes.
- Possibility of installation also in car parks with low ceilings, frequent in the city, thanks to the reduced vertical clearance.
- Completeness of the solution proposed, which is not limited to the offer of the fans, but which is enriched with a wide catalogue of accessories (alarm control units, sensors, shutters, etc.) accompanying the system, and gives it value with the support service to the design of the system offered as an optional.

Versions

- 2 models, different due to dimensions and performance.

Technical features

- Construction in galvanised sheet steel, characterised by reduced thickness (height varies from 295 mm in the 560 model to 335 mm in the 630 model), to promote installation in premises with limited height.
- Radial fans with backward-curve blade impellers with nominal diameter of 560 and 630 mm.
- Double speed, three-phase induction motors, with shafts mounted on ball bearings (Dahlander system).
- Galvanised sheet steel brackets for ceiling installation, supplied as per standard with the product.
- Electric junction boxes mounted outside the products, easy to access for correct wiring of the product to the mains.



TECHNICAL DATA

PRODUCTS	CODE	DIAM. Ø (M)	V~50HZ	MOTOR POWER (KW)	A	POLES	FLOW RATE M ³ /H MIN/MAX	AIR SPEED (M/S)	LP DB(A) MIN/MAX @ 1 M	CLASS.	THRUST (N)	KG
VORT JET-R 560/2	45657	560	400	0.36 1.44	1.55 3.5	2/4	2858 5087	12.6 25.6	58 73	F300-120	50 12	83
VORT JET-R 630/2	45659	630	400	0.66 2.64	2.42 6.05	2/4	3830 9072	13.3 31.5	59 74	F300-120	96 17	143

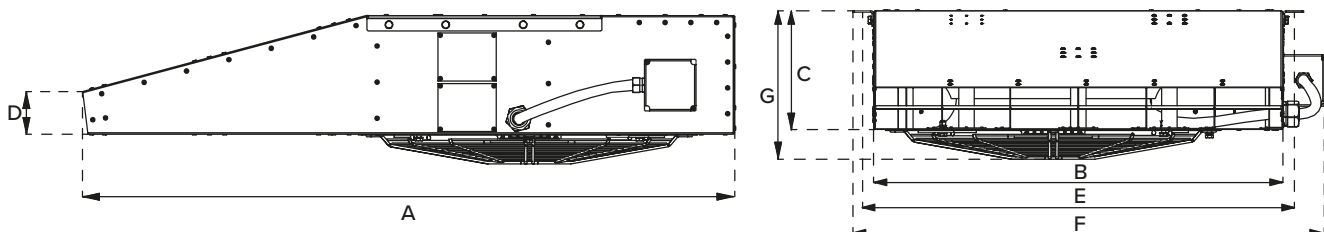

DIMENSIONS



PRODUCTS	A	B	C	D	E	F	G
VORT JET-R 560/2	1265	795	230	80	837	920	295
VORT JET-R 630/2	1830	1150	290	67	1200	1275	335

Dimensions mm

ACCESORIES

MODELS	DESCRIPTION	CODE	PRODUCTS
	SRM - Galvanized steel sheet motorised rectangular dampers for wall installation. The dampers are available in many heights, varying in steps of 200 mm, equal to the height of the individual fin, up to a maximum of 2000 mm. They are also available in various lengths, in the range of 200 mm and 2000 mm in steps of 50 mm.		
		Ø 400	21438 SCM-400
		Ø 450	21439 SCM-450
		Ø 500	21440 SCM-500
		Ø560	SCM-560
		Ø 630	21442 SCM-630
		Ø 710	21443 SCM-710
		Ø 800	21444 SCM-800
		Ø 900	21445 SCM-900
		Ø 1000	21446 SCM-1000
		Ø 1120	21447 SCM-1120
		Ø 1250	21448 SCM-1250
		Ø 1400	21449 SCM-1400
	SCM - Galvanized steel sheet motorised circular dampers for installation on walls and coupled with axial fans.		



SOFTWARE



Fan Selection

VORTICE Fan selection allows customers the ability to select the right fan starting from the duty point (flow rate and static pressure) in case MPC HP and MPC ED. The fan selection process has been designed for an easy use.

Fans can be selected from categories ranging from “MPC HP” to “MPC ED” to "VORT JET". These categories can be further broken down into diameter, prices and efficiency.

Once the product category/type are selected and the operating conditions are entered, the program searches across all available products to meet the selection criteria. Once a fan is selected, the user has the option to view its technical data, its performance curve (if any) and its identification code, print the results or save the selection for future uses. In addition, he can create a drawing for the selected fan. The software allows the user to specify a very detailed list of input data and parameters. It enables also a very detailed and specific selection, giving the user the possibility to specify a wide range of information for the fans to be selected. In a very quick and straightforward way, the software propose a set of fans that match the input criteria.

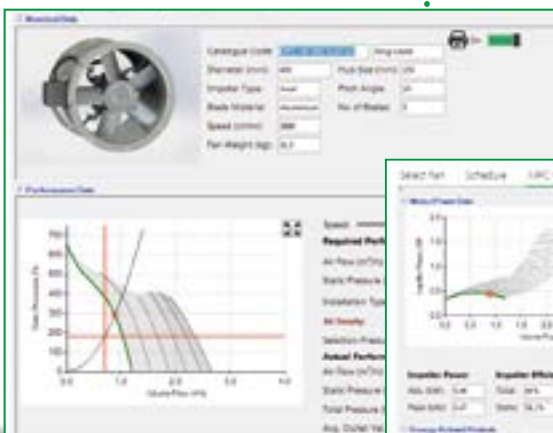
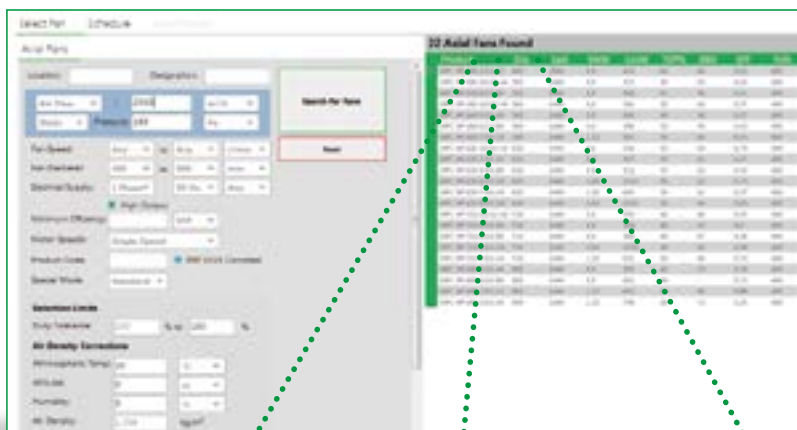





VORT JET R F400 RANGE

Impulse axial jet fans



Impulse jet fans (axial) specifically designed for installation in underground car parks, guaranteeing the correct removal of exhaust gases and, in the event of fire, the effective and prompt extraction of high temperature fumes and the simultaneous creation of suitable escape routes for the occupants.

There are many benefits from installing this type of appliance and they can be summarised as:

- High efficacy: the area of propagation of the fire smoke is limited in view of its rapid removal.
- Easy and economic installation, in virtue of the absence of piping and ducts.
- Reduced consumption, up to 40% lower with respect to traditional ventilation systems, thanks to no head losses that can be traced to the piping.
- Lower electric plant costs, given the possibility to use smaller and less expensive emergency generators.
- Easy maintenance.
- Flexible installation, thanks to proportionally reduced clearance.
- Maximised use of car park volumes, given the absence of cumbersome ducts.

Key features

- Thanks to the double speed motors, it is possible to combine operation in ventilation mode (to guarantee suitable ventilation in the car park) to that of Fire Safety (with the action of the appropriately positioned MPC ED and MPC HP fans), appropriately positioned in the car park, for the extraction of fumes and the simultaneous contribution of non-polluted air in correspondence with escape routes.
- Possibility of guaranteeing safety of the car park in the event of fire by minimising the number of units installed, thanks to the possibility of inverting the direction of the flow induced (Reversible R versions).
- Possibility of installation in car parks with low ceilings, frequent in the city, thanks to the availability of models with reduced diameter.
- Completeness of the solution proposed, which is not limited to the offer of the fans, but which is enriched with a wide catalogue of accessories (alarm control units, sensors, shutters, etc.) accompanying the system, and gives it value with the support service to the design of the system offered as an optional.

Versions

3 models, different in size, functions and performance provided.

Technical features

- Fire resistance certified F400/120.
- Casings made of galvanised steel sheet, characterised by reduced thickness (height varies from 281 mm to 352.5 mm, depending on the model), to promote installation in premises with limited height.
- Class H, double speed, (Dahlander) three-phase motors with shafts mounted on ball bearings. The model equipped with a 630 mm impeller is available in standard and enhanced version (S variant).
- Steel sheet brackets for ceiling installation, supplied as per standard with the product.
- Electric junction boxes mounted outside the products, easy to access for correct wiring of the product to the mains.



TECHNICAL DATA

PRODUCTS	CODE	DIAM. Ø (M)	V~50HZ	MOTOR POWER (KW)	A	POLES	FLOW RATE M ³ /H MIN/MAX	AIR SPEED (M/S)	LP DB(A) MIN/MAX @ 1 M	CLASS.	THRUST (N)	KG
VORT JET-R 560/2 F400	45717	560	400	0,18	1,14	4	2900	11,9	59	F400/120	50	83
				1,1	2,71	8	5800	23,9	75			
VORT JET-R 630/2 F400	45718	630	400	0,37	1,8	4	4150	14,4	61	F400/120	75	130
				2,2	5,6	8	8300	28,7	77			
VORT JET-R 630/2 S F400	45719	630	400	0,38	1,9	4	4600	15,9	63	F400/120	75	130
				2,2	5,6	8	9200	31,9	78			

DIMENSIONS

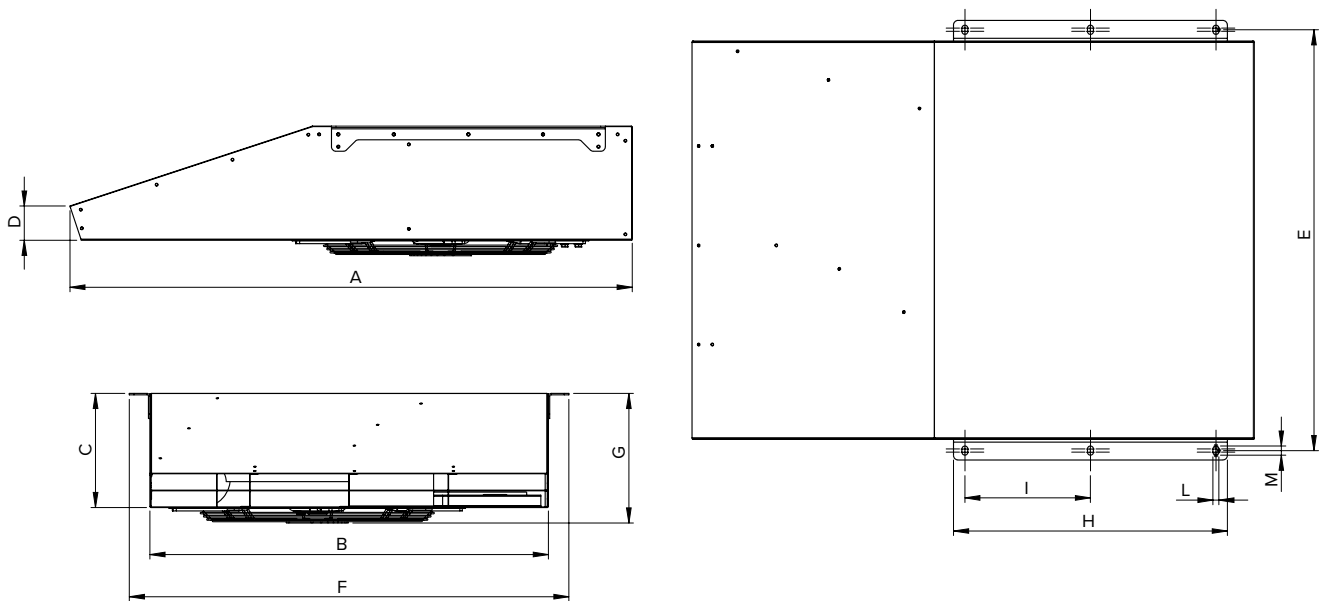

PRODUCT	A	B	C	D	E	F	G	H	I	L	M
VORT JET-R 560/2 F400	1232	873	250	75	922	963	284	600	275	13	20
VORT JET-R 630/2 F400	1601	1003	300	77	1052	1093	354	800	250	13	20
VORT JET-R 630/2 S F400	1601	1003	300	77	1052	1093	354	800	250	13	20

Dimensions (mm)



SOFTWARE



Fan Selection PRO

VORTICE Fan selection Pro is the latest development of the Vortice selection software.

All that you need to know about Vortice products is available in our free selection software at: vortice.com

With **Fan selection Pro**, powered by Vortice, it is possible to find the most suitable fan to the needs of an installation by introducing an airflow and pressure point, and/or using filters for fan, motor, turbine, blades, among many others. Quickly and easily you will find the product you need for your ventilation system and even make comparatives between different options that are listed to the search results.

After finding the desired product or products just click to get a technical report in PDF with all technical information: image, description, RRP, characteristic curve (with static pressure, dynamic pressure, total pressure, power consumption, performance and resistive curve, static, dynamic pressure, total pressure, absorbed power, performance, resistive curve, mechanical power, static and total efficiencies without motor and assembled), acoustic spectrum, dimensions drawing, wiring diagram, related accessories and related documentation (manuals, certificates, EC declaration of conformity, declaration of performance, etc.).

The latest improvement of **VORTICE Fan selection Pro** allows to make the optimal selection of the motor depending on the requested outy point.

Now **VORTICE Fan selection Pro** offers the possibility to select the most efficient fan for a specific installation.

More data shown with more types of curve:

- Mechanical power
- Absorbed power
- Static and total efficiencies without the engine and the assembled assembly (with the engine included, taking into account the efficiency of the engine depending on the factor of use thereof).

Not all **Vortice Fan selection Pro** users have the same privileges to access the information. Registration is required in order to have all options available. To learn everything the software offers you, register and access the program now for free.

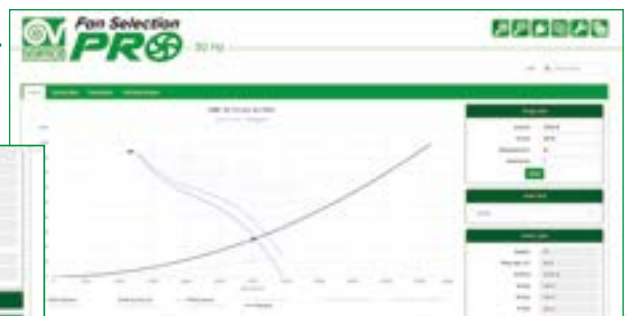





Efectis

Certification of conformity to EN 12101-3 standard issued by EFACTIS

MPC-ED RANGE

Fully cased axial flow fans



Double-use ducted axial fans (ventilation in normal conditions and use in emergencies, for the evacuation of hot fumes) certified F300/120 in compliance with the EN 12101-3 standard, with long fully-cased housing and impellers with blades that can be adjusted when at a standstill to offer high performance flexibility and characterized by high performance and great efficiency. The fans of the VORTICE MPC ED range can be mounted horizontally or vertically and are designed to meet the ventilation requirements of large commercial and industrial environments.

Key features

- Full compliance with the EN 12101-3 standard (ZUS certification), class F300/120.
- High performance: up to 190,000 m³/h.
- Robust and corrosion-resistant construction, thanks to the hot galvanised sheet cases.
- Simple, quick and economic installation, thanks to the long casing used on all models.
- Wide range of continuous operating temperatures when operating as air extractors: - 15°C / + 50°C.

Versions

12 nominal diameters (from 400 mm to 1400 mm), with flow rates up to 190,000 m³/h /h (52.8 m³/s). Each diameter is in turn available with a range of variants, which differ by number and angle of inclination of the blades, size and number of poles and length of the case to cover a wide range of application requirements.

Caratteristiche tecniche

- Hot galvanised sheet steel containment cases, for high corrosion resistance.
- Variable pitch die-cast aluminium impellers with airfoil blades, to guarantee high efficiency with angle of blade inclination adjusted at standstill, dynamically balanced to minimize vibrations and ensure regular operation.
- Class H single or three-phase motors with 2 or 4 poles, depending on the model, in class H and characterized by IP55 degree of protection. Double speed three-phase motors (Dahlander), with 2/4 and 4/8 poles, available upon request. The speed of the three-phase motors can be controlled via inverter (optional).
- External terminal board boxes outside the airflow with IP67 degree of protection.

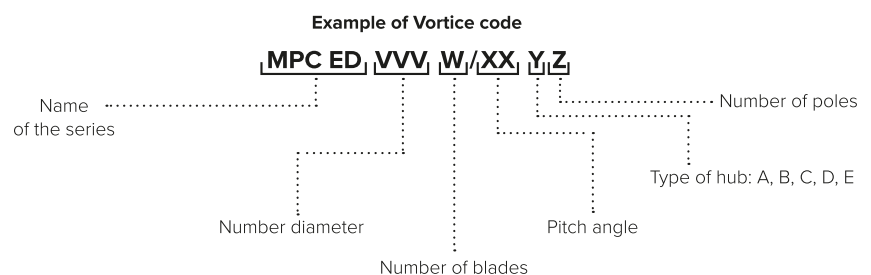
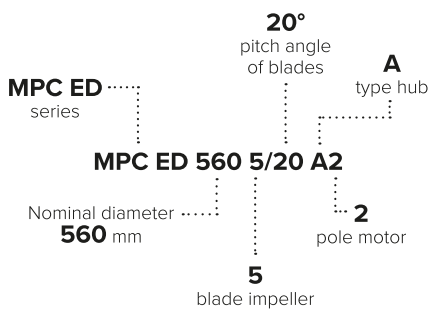



TECHNICAL DATA*

PRODUCTS	DIAM. Ø	BLADE ANGLE MIN/MAX	FLOW RATE (M ³ /H) MIN/MAX FLOW @ 0 Pa	STATIC RESSURE RANGE (Pa) MIN/MAX	STATIC PRESSURE RANGE (Pa) WATER INCHS MIN/MAX	SPEED (RPM) MIN/MAX	N° OF POLES MIN/MAX	POWER RANGE (kW) MIN/MAX	TOTAL EFFICIENCY % MIN/MAX																																																																																																																											
MPC-ED-400	400	10° - 34°	2153	76	0,30	3000 - 1500	2 - 4	0,75 - 2,2 kW	55% - 85%																																																																																																																											
			9572	600	2,40					MPC-ED-500	500	10° - 34°	4175	91	0,36	3000 - 1500	2 - 4	0,75 - 5,5 kW	55% - 85%	18973	838	3,36	MPC-ED-560	560	10° - 34°	4681	113	0,45	3000 - 1500	2 - 4	0,75 - 9,2 kW	55% - 85%	27410	1254	5,03	MPC-ED-630	630	10° - 34°	6916	122	0,48	3000 - 1500	2 - 4	0,75 - 18,5 kW	55% - 85%	37732	1400	5,62	MPC-ED-710	710	10° - 34°	9971	139	0,55	3000 - 1500	2 - 4	0,75 - 37 kW	55% - 85%	56305	1700	6,82	MPC-ED-800	800	10° - 34°	12998	146	0,58	3000 - 1500	2 - 4	0,75 - 37 kW	55% - 85%	71450	2561	10,28	MPC-ED-900	900	10° - 34°	16879	168	0,67	1500	4	0,75 - 22 kW	55% - 85%	59647	750	3,01	MPC-ED-1000	1000	10° - 34°	24042	246	0,98	1500	4	1,5 - 30 kW	55% - 85%	81066	974	3,91	MPC-ED-1120	1120	10° - 34°	39159	396	1,58	1500	4	4 - 45 kW	55% - 85%	111958	1000	4,01	MPC-ED-1250	1250	10° - 34°	51120	438	1,75	1500	4	5,5 - 55 kW	55% - 85%	155.002	1.200	4,81	MPC-ED-1400	1400	10° - 34°	63514	715	2,87
MPC-ED-500	500	10° - 34°	4175	91	0,36	3000 - 1500	2 - 4	0,75 - 5,5 kW	55% - 85%																																																																																																																											
			18973	838	3,36					MPC-ED-560	560	10° - 34°	4681	113	0,45	3000 - 1500	2 - 4	0,75 - 9,2 kW	55% - 85%	27410	1254	5,03	MPC-ED-630	630	10° - 34°	6916	122	0,48	3000 - 1500	2 - 4	0,75 - 18,5 kW	55% - 85%	37732	1400	5,62	MPC-ED-710	710	10° - 34°	9971	139	0,55	3000 - 1500	2 - 4	0,75 - 37 kW	55% - 85%	56305	1700	6,82	MPC-ED-800	800	10° - 34°	12998	146	0,58	3000 - 1500	2 - 4	0,75 - 37 kW	55% - 85%	71450	2561	10,28	MPC-ED-900	900	10° - 34°	16879	168	0,67	1500	4	0,75 - 22 kW	55% - 85%	59647	750	3,01	MPC-ED-1000	1000	10° - 34°	24042	246	0,98	1500	4	1,5 - 30 kW	55% - 85%	81066	974	3,91	MPC-ED-1120	1120	10° - 34°	39159	396	1,58	1500	4	4 - 45 kW	55% - 85%	111958	1000	4,01	MPC-ED-1250	1250	10° - 34°	51120	438	1,75	1500	4	5,5 - 55 kW	55% - 85%	155.002	1.200	4,81	MPC-ED-1400	1400	10° - 34°	63514	715	2,87	1500	4	7,5 - 55 kW	55% - 85%	193556	1310	5,25						
MPC-ED-560	560	10° - 34°	4681	113	0,45	3000 - 1500	2 - 4	0,75 - 9,2 kW	55% - 85%																																																																																																																											
			27410	1254	5,03					MPC-ED-630	630	10° - 34°	6916	122	0,48	3000 - 1500	2 - 4	0,75 - 18,5 kW	55% - 85%	37732	1400	5,62	MPC-ED-710	710	10° - 34°	9971	139	0,55	3000 - 1500	2 - 4	0,75 - 37 kW	55% - 85%	56305	1700	6,82	MPC-ED-800	800	10° - 34°	12998	146	0,58	3000 - 1500	2 - 4	0,75 - 37 kW	55% - 85%	71450	2561	10,28	MPC-ED-900	900	10° - 34°	16879	168	0,67	1500	4	0,75 - 22 kW	55% - 85%	59647	750	3,01	MPC-ED-1000	1000	10° - 34°	24042	246	0,98	1500	4	1,5 - 30 kW	55% - 85%	81066	974	3,91	MPC-ED-1120	1120	10° - 34°	39159	396	1,58	1500	4	4 - 45 kW	55% - 85%	111958	1000	4,01	MPC-ED-1250	1250	10° - 34°	51120	438	1,75	1500	4	5,5 - 55 kW	55% - 85%	155.002	1.200	4,81	MPC-ED-1400	1400	10° - 34°	63514	715	2,87	1500	4	7,5 - 55 kW	55% - 85%	193556	1310	5,25																			
MPC-ED-630	630	10° - 34°	6916	122	0,48	3000 - 1500	2 - 4	0,75 - 18,5 kW	55% - 85%																																																																																																																											
			37732	1400	5,62					MPC-ED-710	710	10° - 34°	9971	139	0,55	3000 - 1500	2 - 4	0,75 - 37 kW	55% - 85%	56305	1700	6,82	MPC-ED-800	800	10° - 34°	12998	146	0,58	3000 - 1500	2 - 4	0,75 - 37 kW	55% - 85%	71450	2561	10,28	MPC-ED-900	900	10° - 34°	16879	168	0,67	1500	4	0,75 - 22 kW	55% - 85%	59647	750	3,01	MPC-ED-1000	1000	10° - 34°	24042	246	0,98	1500	4	1,5 - 30 kW	55% - 85%	81066	974	3,91	MPC-ED-1120	1120	10° - 34°	39159	396	1,58	1500	4	4 - 45 kW	55% - 85%	111958	1000	4,01	MPC-ED-1250	1250	10° - 34°	51120	438	1,75	1500	4	5,5 - 55 kW	55% - 85%	155.002	1.200	4,81	MPC-ED-1400	1400	10° - 34°	63514	715	2,87	1500	4	7,5 - 55 kW	55% - 85%	193556	1310	5,25																																
MPC-ED-710	710	10° - 34°	9971	139	0,55	3000 - 1500	2 - 4	0,75 - 37 kW	55% - 85%																																																																																																																											
			56305	1700	6,82					MPC-ED-800	800	10° - 34°	12998	146	0,58	3000 - 1500	2 - 4	0,75 - 37 kW	55% - 85%	71450	2561	10,28	MPC-ED-900	900	10° - 34°	16879	168	0,67	1500	4	0,75 - 22 kW	55% - 85%	59647	750	3,01	MPC-ED-1000	1000	10° - 34°	24042	246	0,98	1500	4	1,5 - 30 kW	55% - 85%	81066	974	3,91	MPC-ED-1120	1120	10° - 34°	39159	396	1,58	1500	4	4 - 45 kW	55% - 85%	111958	1000	4,01	MPC-ED-1250	1250	10° - 34°	51120	438	1,75	1500	4	5,5 - 55 kW	55% - 85%	155.002	1.200	4,81	MPC-ED-1400	1400	10° - 34°	63514	715	2,87	1500	4	7,5 - 55 kW	55% - 85%	193556	1310	5,25																																													
MPC-ED-800	800	10° - 34°	12998	146	0,58	3000 - 1500	2 - 4	0,75 - 37 kW	55% - 85%																																																																																																																											
			71450	2561	10,28					MPC-ED-900	900	10° - 34°	16879	168	0,67	1500	4	0,75 - 22 kW	55% - 85%	59647	750	3,01	MPC-ED-1000	1000	10° - 34°	24042	246	0,98	1500	4	1,5 - 30 kW	55% - 85%	81066	974	3,91	MPC-ED-1120	1120	10° - 34°	39159	396	1,58	1500	4	4 - 45 kW	55% - 85%	111958	1000	4,01	MPC-ED-1250	1250	10° - 34°	51120	438	1,75	1500	4	5,5 - 55 kW	55% - 85%	155.002	1.200	4,81	MPC-ED-1400	1400	10° - 34°	63514	715	2,87	1500	4	7,5 - 55 kW	55% - 85%	193556	1310	5,25																																																										
MPC-ED-900	900	10° - 34°	16879	168	0,67	1500	4	0,75 - 22 kW	55% - 85%																																																																																																																											
			59647	750	3,01					MPC-ED-1000	1000	10° - 34°	24042	246	0,98	1500	4	1,5 - 30 kW	55% - 85%	81066	974	3,91	MPC-ED-1120	1120	10° - 34°	39159	396	1,58	1500	4	4 - 45 kW	55% - 85%	111958	1000	4,01	MPC-ED-1250	1250	10° - 34°	51120	438	1,75	1500	4	5,5 - 55 kW	55% - 85%	155.002	1.200	4,81	MPC-ED-1400	1400	10° - 34°	63514	715	2,87	1500	4	7,5 - 55 kW	55% - 85%	193556	1310	5,25																																																																							
MPC-ED-1000	1000	10° - 34°	24042	246	0,98	1500	4	1,5 - 30 kW	55% - 85%																																																																																																																											
			81066	974	3,91					MPC-ED-1120	1120	10° - 34°	39159	396	1,58	1500	4	4 - 45 kW	55% - 85%	111958	1000	4,01	MPC-ED-1250	1250	10° - 34°	51120	438	1,75	1500	4	5,5 - 55 kW	55% - 85%	155.002	1.200	4,81	MPC-ED-1400	1400	10° - 34°	63514	715	2,87	1500	4	7,5 - 55 kW	55% - 85%	193556	1310	5,25																																																																																				
MPC-ED-1120	1120	10° - 34°	39159	396	1,58	1500	4	4 - 45 kW	55% - 85%																																																																																																																											
			111958	1000	4,01					MPC-ED-1250	1250	10° - 34°	51120	438	1,75	1500	4	5,5 - 55 kW	55% - 85%	155.002	1.200	4,81	MPC-ED-1400	1400	10° - 34°	63514	715	2,87	1500	4	7,5 - 55 kW	55% - 85%	193556	1310	5,25																																																																																																	
MPC-ED-1250	1250	10° - 34°	51120	438	1,75	1500	4	5,5 - 55 kW	55% - 85%																																																																																																																											
			155.002	1.200	4,81					MPC-ED-1400	1400	10° - 34°	63514	715	2,87	1500	4	7,5 - 55 kW	55% - 85%	193556	1310	5,25																																																																																																														
MPC-ED-1400	1400	10° - 34°	63514	715	2,87	1500	4	7,5 - 55 kW	55% - 85%																																																																																																																											
			193556	1310	5,25																																																																																																																															

*data represent the range of values for each diameter



INDUSTRIAL VENTILATION

MPC-ED RANGE

TECHNICAL DATA*

PRODUCTS	DIAM. Ø	BLADE ANGLE MIN/MAX	FLOW RATE (M ³ /H) MIN/MAX FLOW @ 0 Pa	STATIC RESSURE RANGE (Pa) MIN/MAX	STATIC PRESSURE RANGE (Pa) WATER INCHS MIN/MAX	SPEED (RPM) MIN/MAX	N° OF POLES MIN/MAX	POWER RANGE (kW) MIN/MAX	TOTAL EFFICIENCY % MIN/MAX																																																																																																																											
MPC-ED-400	400	10° - 34°	982	24	0,09	3000/1500 1500/750	2/4 4/8	0,15 - 2,2 kW	55% - 85%																																																																																																																											
			9562	612	2,45					MPC-ED-500	500	10° - 34°	1720	34	0,13	3000/1500 1500/750	2/4 4/8	0,15 - 4,4 kW	55% - 85%	18844	811	3,25	MPC-ED-560	560	10° - 34°	2200	28	0,11	3000/1500 1500/750	2/4 4/8	0,3 - 8 kW	55% - 85%	26338	1267	5,08	MPC-ED-630	630	10° - 34°	3235	30	0,12	3000/1500 1500/750	2/4 4/8	0,3 - 16 kW	55% - 85%	37616	1868	7,49	MPC-ED-710	710	10° - 34°	4400	35	0,14	3000/1500 1500/750	2/4 4/8	0,15 - 33 kW	55% - 85%	53864	2195	8,81	MPC-ED-800	800	10° - 34°	5815	36	0,14	3000/1500 1500/750	2/4 4/8	0,15 - 33 kW	55% - 85%	66772	2708	10,87	MPC-ED-900	900	10° - 34°	7675	44	0,17	1500/750	4/8	0,2 - 20 kW	55% - 85%	59522	901	3,61	MPC-ED-1000	1.000	10° - 34°	10990	61	0,24	1500/750	4/8	0,4 - 28 kW	55% - 85%	80914	1053	4,22	MPC-ED-1120	1.120	10° - 34°	18854	99	0,39	1500/750	4/8	1,8 - 37 kW	55% - 85%	111702	1090	4,37	MPC-ED-1250	1.250	10° - 34°	24668	109	0,43	1500/750	4/8	3 - 55 kW	55% - 85%	154792	888	3,56	MPC-ED-1400	1.400	10° - 34°	30876	119	0,47
MPC-ED-500	500	10° - 34°	1720	34	0,13	3000/1500 1500/750	2/4 4/8	0,15 - 4,4 kW	55% - 85%																																																																																																																											
			18844	811	3,25					MPC-ED-560	560	10° - 34°	2200	28	0,11	3000/1500 1500/750	2/4 4/8	0,3 - 8 kW	55% - 85%	26338	1267	5,08	MPC-ED-630	630	10° - 34°	3235	30	0,12	3000/1500 1500/750	2/4 4/8	0,3 - 16 kW	55% - 85%	37616	1868	7,49	MPC-ED-710	710	10° - 34°	4400	35	0,14	3000/1500 1500/750	2/4 4/8	0,15 - 33 kW	55% - 85%	53864	2195	8,81	MPC-ED-800	800	10° - 34°	5815	36	0,14	3000/1500 1500/750	2/4 4/8	0,15 - 33 kW	55% - 85%	66772	2708	10,87	MPC-ED-900	900	10° - 34°	7675	44	0,17	1500/750	4/8	0,2 - 20 kW	55% - 85%	59522	901	3,61	MPC-ED-1000	1.000	10° - 34°	10990	61	0,24	1500/750	4/8	0,4 - 28 kW	55% - 85%	80914	1053	4,22	MPC-ED-1120	1.120	10° - 34°	18854	99	0,39	1500/750	4/8	1,8 - 37 kW	55% - 85%	111702	1090	4,37	MPC-ED-1250	1.250	10° - 34°	24668	109	0,43	1500/750	4/8	3 - 55 kW	55% - 85%	154792	888	3,56	MPC-ED-1400	1.400	10° - 34°	30876	119	0,47	1500/750	4/8	3 - 55 kW	55% - 85%	188852	1327	5,32						
MPC-ED-560	560	10° - 34°	2200	28	0,11	3000/1500 1500/750	2/4 4/8	0,3 - 8 kW	55% - 85%																																																																																																																											
			26338	1267	5,08					MPC-ED-630	630	10° - 34°	3235	30	0,12	3000/1500 1500/750	2/4 4/8	0,3 - 16 kW	55% - 85%	37616	1868	7,49	MPC-ED-710	710	10° - 34°	4400	35	0,14	3000/1500 1500/750	2/4 4/8	0,15 - 33 kW	55% - 85%	53864	2195	8,81	MPC-ED-800	800	10° - 34°	5815	36	0,14	3000/1500 1500/750	2/4 4/8	0,15 - 33 kW	55% - 85%	66772	2708	10,87	MPC-ED-900	900	10° - 34°	7675	44	0,17	1500/750	4/8	0,2 - 20 kW	55% - 85%	59522	901	3,61	MPC-ED-1000	1.000	10° - 34°	10990	61	0,24	1500/750	4/8	0,4 - 28 kW	55% - 85%	80914	1053	4,22	MPC-ED-1120	1.120	10° - 34°	18854	99	0,39	1500/750	4/8	1,8 - 37 kW	55% - 85%	111702	1090	4,37	MPC-ED-1250	1.250	10° - 34°	24668	109	0,43	1500/750	4/8	3 - 55 kW	55% - 85%	154792	888	3,56	MPC-ED-1400	1.400	10° - 34°	30876	119	0,47	1500/750	4/8	3 - 55 kW	55% - 85%	188852	1327	5,32																			
MPC-ED-630	630	10° - 34°	3235	30	0,12	3000/1500 1500/750	2/4 4/8	0,3 - 16 kW	55% - 85%																																																																																																																											
			37616	1868	7,49					MPC-ED-710	710	10° - 34°	4400	35	0,14	3000/1500 1500/750	2/4 4/8	0,15 - 33 kW	55% - 85%	53864	2195	8,81	MPC-ED-800	800	10° - 34°	5815	36	0,14	3000/1500 1500/750	2/4 4/8	0,15 - 33 kW	55% - 85%	66772	2708	10,87	MPC-ED-900	900	10° - 34°	7675	44	0,17	1500/750	4/8	0,2 - 20 kW	55% - 85%	59522	901	3,61	MPC-ED-1000	1.000	10° - 34°	10990	61	0,24	1500/750	4/8	0,4 - 28 kW	55% - 85%	80914	1053	4,22	MPC-ED-1120	1.120	10° - 34°	18854	99	0,39	1500/750	4/8	1,8 - 37 kW	55% - 85%	111702	1090	4,37	MPC-ED-1250	1.250	10° - 34°	24668	109	0,43	1500/750	4/8	3 - 55 kW	55% - 85%	154792	888	3,56	MPC-ED-1400	1.400	10° - 34°	30876	119	0,47	1500/750	4/8	3 - 55 kW	55% - 85%	188852	1327	5,32																																
MPC-ED-710	710	10° - 34°	4400	35	0,14	3000/1500 1500/750	2/4 4/8	0,15 - 33 kW	55% - 85%																																																																																																																											
			53864	2195	8,81					MPC-ED-800	800	10° - 34°	5815	36	0,14	3000/1500 1500/750	2/4 4/8	0,15 - 33 kW	55% - 85%	66772	2708	10,87	MPC-ED-900	900	10° - 34°	7675	44	0,17	1500/750	4/8	0,2 - 20 kW	55% - 85%	59522	901	3,61	MPC-ED-1000	1.000	10° - 34°	10990	61	0,24	1500/750	4/8	0,4 - 28 kW	55% - 85%	80914	1053	4,22	MPC-ED-1120	1.120	10° - 34°	18854	99	0,39	1500/750	4/8	1,8 - 37 kW	55% - 85%	111702	1090	4,37	MPC-ED-1250	1.250	10° - 34°	24668	109	0,43	1500/750	4/8	3 - 55 kW	55% - 85%	154792	888	3,56	MPC-ED-1400	1.400	10° - 34°	30876	119	0,47	1500/750	4/8	3 - 55 kW	55% - 85%	188852	1327	5,32																																													
MPC-ED-800	800	10° - 34°	5815	36	0,14	3000/1500 1500/750	2/4 4/8	0,15 - 33 kW	55% - 85%																																																																																																																											
			66772	2708	10,87					MPC-ED-900	900	10° - 34°	7675	44	0,17	1500/750	4/8	0,2 - 20 kW	55% - 85%	59522	901	3,61	MPC-ED-1000	1.000	10° - 34°	10990	61	0,24	1500/750	4/8	0,4 - 28 kW	55% - 85%	80914	1053	4,22	MPC-ED-1120	1.120	10° - 34°	18854	99	0,39	1500/750	4/8	1,8 - 37 kW	55% - 85%	111702	1090	4,37	MPC-ED-1250	1.250	10° - 34°	24668	109	0,43	1500/750	4/8	3 - 55 kW	55% - 85%	154792	888	3,56	MPC-ED-1400	1.400	10° - 34°	30876	119	0,47	1500/750	4/8	3 - 55 kW	55% - 85%	188852	1327	5,32																																																										
MPC-ED-900	900	10° - 34°	7675	44	0,17	1500/750	4/8	0,2 - 20 kW	55% - 85%																																																																																																																											
			59522	901	3,61					MPC-ED-1000	1.000	10° - 34°	10990	61	0,24	1500/750	4/8	0,4 - 28 kW	55% - 85%	80914	1053	4,22	MPC-ED-1120	1.120	10° - 34°	18854	99	0,39	1500/750	4/8	1,8 - 37 kW	55% - 85%	111702	1090	4,37	MPC-ED-1250	1.250	10° - 34°	24668	109	0,43	1500/750	4/8	3 - 55 kW	55% - 85%	154792	888	3,56	MPC-ED-1400	1.400	10° - 34°	30876	119	0,47	1500/750	4/8	3 - 55 kW	55% - 85%	188852	1327	5,32																																																																							
MPC-ED-1000	1.000	10° - 34°	10990	61	0,24	1500/750	4/8	0,4 - 28 kW	55% - 85%																																																																																																																											
			80914	1053	4,22					MPC-ED-1120	1.120	10° - 34°	18854	99	0,39	1500/750	4/8	1,8 - 37 kW	55% - 85%	111702	1090	4,37	MPC-ED-1250	1.250	10° - 34°	24668	109	0,43	1500/750	4/8	3 - 55 kW	55% - 85%	154792	888	3,56	MPC-ED-1400	1.400	10° - 34°	30876	119	0,47	1500/750	4/8	3 - 55 kW	55% - 85%	188852	1327	5,32																																																																																				
MPC-ED-1120	1.120	10° - 34°	18854	99	0,39	1500/750	4/8	1,8 - 37 kW	55% - 85%																																																																																																																											
			111702	1090	4,37					MPC-ED-1250	1.250	10° - 34°	24668	109	0,43	1500/750	4/8	3 - 55 kW	55% - 85%	154792	888	3,56	MPC-ED-1400	1.400	10° - 34°	30876	119	0,47	1500/750	4/8	3 - 55 kW	55% - 85%	188852	1327	5,32																																																																																																	
MPC-ED-1250	1.250	10° - 34°	24668	109	0,43	1500/750	4/8	3 - 55 kW	55% - 85%																																																																																																																											
			154792	888	3,56					MPC-ED-1400	1.400	10° - 34°	30876	119	0,47	1500/750	4/8	3 - 55 kW	55% - 85%	188852	1327	5,32																																																																																																														
MPC-ED-1400	1.400	10° - 34°	30876	119	0,47	1500/750	4/8	3 - 55 kW	55% - 85%																																																																																																																											
			188852	1327	5,32																																																																																																																															

*data represent the range of values for each diameter



DIMENSIONS

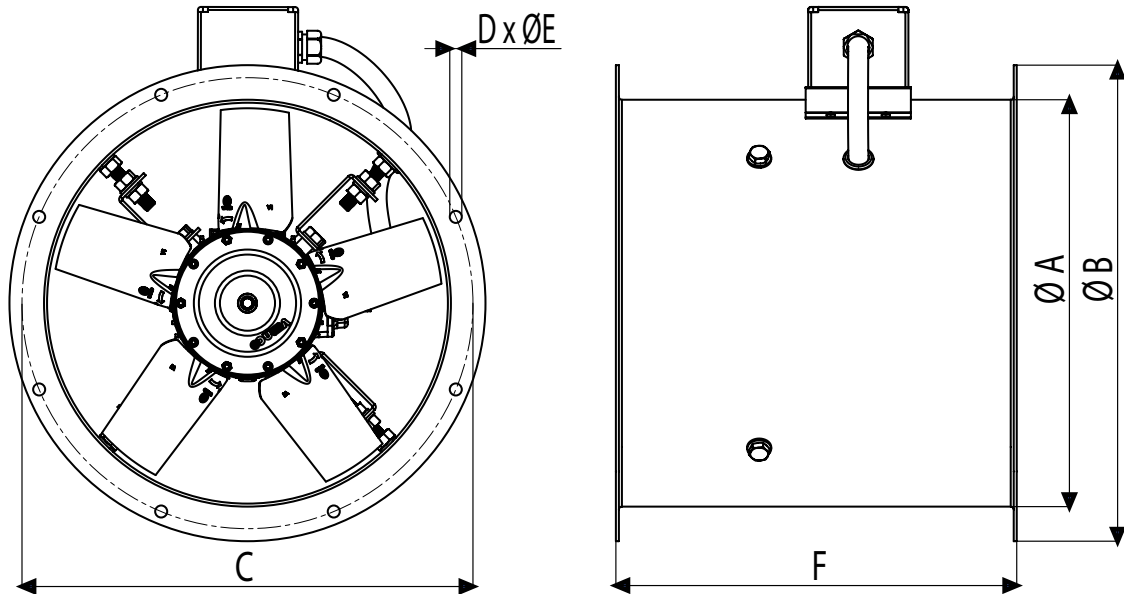

FAN	MOTOR FRAME	Ø A	Ø B	Ø C	D X Ø E	F
400	80	400	475	450	8xØ12	400
	90					
500	80	500	580	560	12xØ12	400
	90					450
	100					400
560	80	560	645	620	12xØ12	400
	90					450
	100					570
	112					400
	132					450
630	80	630	715	690	12xØ12	450
	90					570
	100					710
	112					450
	132					570
710	160	800	885	860	16xØ12	790
	80					840
	112					450
	132					570
	160					710
800	180	800	885	860	16xØ12	790
	200					840
	80					450
	112					570
	132					710
	160					790
	180					790
	200					840

Dimensions (mm)



DIMENSIONS

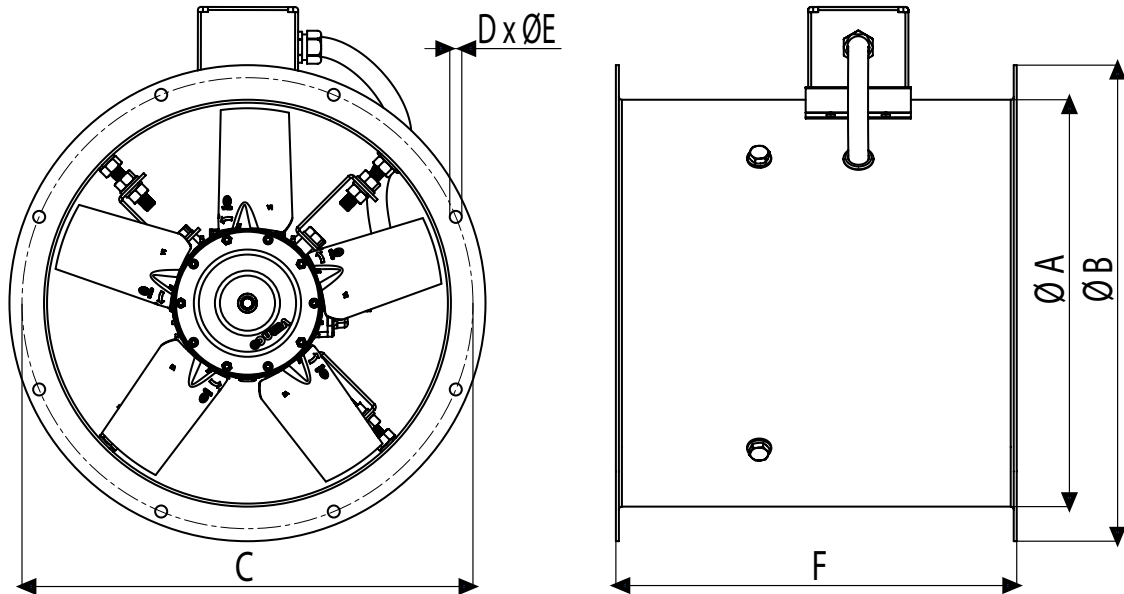

FAN	MOTOR FRAME	Ø A	Ø B	Ø C	D X Ø E	F
900	80	900	1000	970	16xØ12	450
	112					570
	132					710
	160					790
	180					
1000	80	1000	1110	1070	16xØ15	450
	112					590
	132					790
	160					840
	180					
1120	200	1120	1240	1190	20xØ15	590
	100					790
	132					840
	160					1000
	180					
1250	225	1250	1380	1320	20xØ15	590
	100					790
	132					840
	160					1000
	180					1100
1400	250	1400	1540	1470	20xØ15	590
	132					790
	160					840
	180					1000
	200					1100
	225					1100
	250					

Dimensions (mm)



SOFTWARE

Fan Selection

VORTICE Fan selection allows customers the ability to select the right fan starting from the duty point (flow rate and static pressure) in case MPC HP and MPC ED. The fan selection process has been designed for an easy use.

Fans can be selected from categories ranging from “MPC HP” to “MPC ED” to "VORT JET". These categories can be further broken down into diameter, prices and efficiency.

Once the product category/type are selected and the operating conditions are entered, the program searches across all available products to meet the selection criteria. Once a fan is selected, the user has the option to view its technical data, its performance curve (if any) and its identification code, print the results or save the selection for future uses. In addition, he can create a drawing for the selected fan. The software allows the user to specify a very detailed list of input data and parameters. It enables also a very detailed and specific selection, giving the user the possibility to specify a wide range of information for the fans to be selected. In a very quick and straightforward way, the software propose a set of fans that match the input criteria.

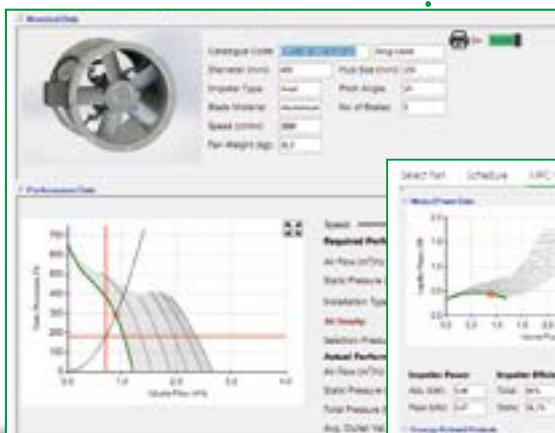
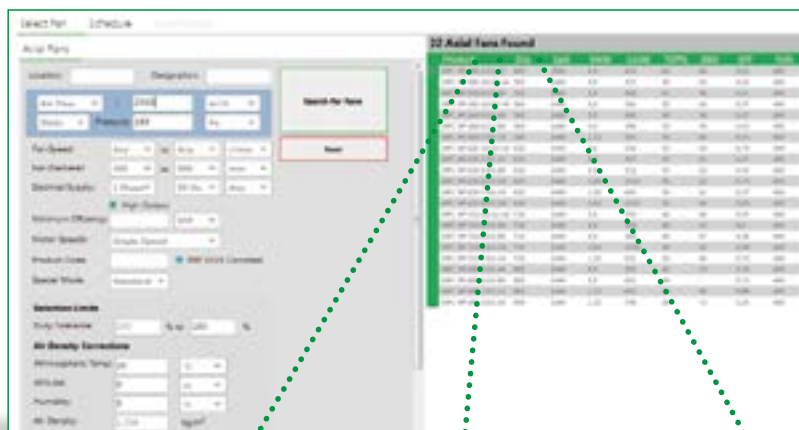



MPC-HP RANGE

Fully cased axial flow fans

Ducted axial fans with long housing cases (“fully cased”) and impellers with adjustable blades when at a standstill to offer high performance flexibility and characterised by high performance and great efficiency. The VORTICE MPC HP range fans can be mounted horizontally or vertically, and are designed to meet the ventilation requirements of large commercial and industrial environments.

Key features

- High performance: up to 190,000 m³/h
- Strong, corrosion resistant construction, thanks to the hot galvanised sheet cases.
- Simple, quick and economic installation, thanks to the long casing used on all models.
- Wide continuous operation temperature range: - 15°C / + 50°C.

Versions

The range is based on 12 nominal diameters (from 400 mm to 1400 mm), with flow rates up to 190,000 m³/h /h (52.8 m³/s). Each diameter is, in turn, available with a range of variants, which differ by number and angle of inclination of the blades, size and number of poles and length of the case, in order to cover a wide range of application requirements.

Technical features

- Hot galvanised sheet steel containment cases, for high corrosion resistance.
- Variable pitch die-cast aluminium impellers with airfoil blades, to guarantee high efficiency with angle of blade inclination adjusted at a standstill, dynamically balanced to minimize vibrations and ensure regular operation.
- Class F single or three-phase motors with 2 or 4 poles, depending on the model, characterized by IP55 protection rating. Double speed three-phase motors (Dahlander), with 2/4 and 4/8 poles, available upon request. The speed of the three-phase motors can be controlled via inverter (optional).
- External terminal board boxes outside the airflow with IP67 degree of protection.

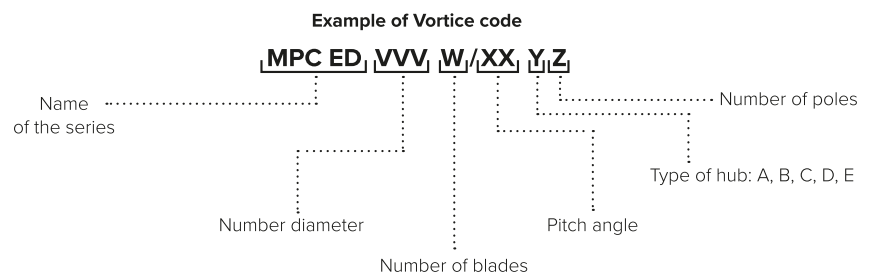
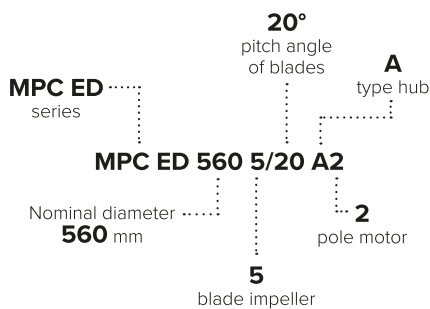



TECHNICAL DATA*

PRODUCTS	DIAM. Ø	BLADE ANGLE MIN/MAX	FLOW RATE (M ³ /H) MIN/MAX FLOW @ 0 Pa	STATIC RESSURE RANGE (Pa) MIN/MAX	STATIC PRESSURE RANGE (Pa) WATER INCHS MIN/MAX	SPEED (RPM) MIN/MAX	N° OF POLES MIN/MAX	POWER RANGE (kW) MIN/MAX	TOTAL EFFICIENCY % MIN/MAX																																																																																																																																								
MPC-HP-400	400	10° - 34°	2167	94	0,37	3000/1500	2/4	0,75 - 2,2 kW	55% - 85%																																																																																																																																								
			9575	860	3,45					MPC-HP-450	450	10° - 34°	3126	113	0,45	3000/1500	2/4	0,75 - 3 kW	55% - 85%	13745	638	2,56	MPC-HP-500	500	10° - 34°	4180	118	0,47	3000/1500	2/4	0,75 - 5,5 kW	55% - 85%	18969	1090	4,37	MPC-HP-560	560	10° - 34°	4683	145	0,58	3000/1500	2/4	0,75 - 11 kW	55% - 85%	27421	1610	6,46	MPC-HP-630	630	10° - 34°	6914	156	0,62	3000/1500	2/4	0,75 - 18,5 kW	55% - 85%	37732	2350	9,43	MPC-HP-710	710	10° - 34°	9970	171	0,68	3000/1500	2/4	0,75 - 37 kW	55% - 85%	56302	2650	10,63	MPC-HP-800	800	10° - 34°	12993	183	0,73	3000/1500	2/4	0,75 - 37 kW	55% - 85%	71464	3250	13,04	MPC-HP-900	900	10° - 34°	16887	203	0,81	1500	4	0,75 - 22 kW	55% - 85%	59651	1050	4,21	MPC-HP-1000	1.000	10° - 34°	24043	301	1,20	1500	4	1,5 - 30 kW	55% - 85%	81061	1250	5,01	MPC-HP-1120	1120	10° - 34°	39166	600	2,40	1500	4	4 - 45 kW	55% - 85%	111967	1280	5,13	MPC-HP-1250	1.250	10° - 34°	51126	709	2,84	1500	4	5,5 - 55 kW	55% - 85%	155193	1520	6,10	MPC-HP-1400	1.400	10° - 34°	63507	540	2,16
MPC-HP-450	450	10° - 34°	3126	113	0,45	3000/1500	2/4	0,75 - 3 kW	55% - 85%																																																																																																																																								
			13745	638	2,56					MPC-HP-500	500	10° - 34°	4180	118	0,47	3000/1500	2/4	0,75 - 5,5 kW	55% - 85%	18969	1090	4,37	MPC-HP-560	560	10° - 34°	4683	145	0,58	3000/1500	2/4	0,75 - 11 kW	55% - 85%	27421	1610	6,46	MPC-HP-630	630	10° - 34°	6914	156	0,62	3000/1500	2/4	0,75 - 18,5 kW	55% - 85%	37732	2350	9,43	MPC-HP-710	710	10° - 34°	9970	171	0,68	3000/1500	2/4	0,75 - 37 kW	55% - 85%	56302	2650	10,63	MPC-HP-800	800	10° - 34°	12993	183	0,73	3000/1500	2/4	0,75 - 37 kW	55% - 85%	71464	3250	13,04	MPC-HP-900	900	10° - 34°	16887	203	0,81	1500	4	0,75 - 22 kW	55% - 85%	59651	1050	4,21	MPC-HP-1000	1.000	10° - 34°	24043	301	1,20	1500	4	1,5 - 30 kW	55% - 85%	81061	1250	5,01	MPC-HP-1120	1120	10° - 34°	39166	600	2,40	1500	4	4 - 45 kW	55% - 85%	111967	1280	5,13	MPC-HP-1250	1.250	10° - 34°	51126	709	2,84	1500	4	5,5 - 55 kW	55% - 85%	155193	1520	6,10	MPC-HP-1400	1.400	10° - 34°	63507	540	2,16	1500	4	7,5 - 55 kW	55% - 85%	193156	1550	6,22						
MPC-HP-500	500	10° - 34°	4180	118	0,47	3000/1500	2/4	0,75 - 5,5 kW	55% - 85%																																																																																																																																								
			18969	1090	4,37					MPC-HP-560	560	10° - 34°	4683	145	0,58	3000/1500	2/4	0,75 - 11 kW	55% - 85%	27421	1610	6,46	MPC-HP-630	630	10° - 34°	6914	156	0,62	3000/1500	2/4	0,75 - 18,5 kW	55% - 85%	37732	2350	9,43	MPC-HP-710	710	10° - 34°	9970	171	0,68	3000/1500	2/4	0,75 - 37 kW	55% - 85%	56302	2650	10,63	MPC-HP-800	800	10° - 34°	12993	183	0,73	3000/1500	2/4	0,75 - 37 kW	55% - 85%	71464	3250	13,04	MPC-HP-900	900	10° - 34°	16887	203	0,81	1500	4	0,75 - 22 kW	55% - 85%	59651	1050	4,21	MPC-HP-1000	1.000	10° - 34°	24043	301	1,20	1500	4	1,5 - 30 kW	55% - 85%	81061	1250	5,01	MPC-HP-1120	1120	10° - 34°	39166	600	2,40	1500	4	4 - 45 kW	55% - 85%	111967	1280	5,13	MPC-HP-1250	1.250	10° - 34°	51126	709	2,84	1500	4	5,5 - 55 kW	55% - 85%	155193	1520	6,10	MPC-HP-1400	1.400	10° - 34°	63507	540	2,16	1500	4	7,5 - 55 kW	55% - 85%	193156	1550	6,22																			
MPC-HP-560	560	10° - 34°	4683	145	0,58	3000/1500	2/4	0,75 - 11 kW	55% - 85%																																																																																																																																								
			27421	1610	6,46					MPC-HP-630	630	10° - 34°	6914	156	0,62	3000/1500	2/4	0,75 - 18,5 kW	55% - 85%	37732	2350	9,43	MPC-HP-710	710	10° - 34°	9970	171	0,68	3000/1500	2/4	0,75 - 37 kW	55% - 85%	56302	2650	10,63	MPC-HP-800	800	10° - 34°	12993	183	0,73	3000/1500	2/4	0,75 - 37 kW	55% - 85%	71464	3250	13,04	MPC-HP-900	900	10° - 34°	16887	203	0,81	1500	4	0,75 - 22 kW	55% - 85%	59651	1050	4,21	MPC-HP-1000	1.000	10° - 34°	24043	301	1,20	1500	4	1,5 - 30 kW	55% - 85%	81061	1250	5,01	MPC-HP-1120	1120	10° - 34°	39166	600	2,40	1500	4	4 - 45 kW	55% - 85%	111967	1280	5,13	MPC-HP-1250	1.250	10° - 34°	51126	709	2,84	1500	4	5,5 - 55 kW	55% - 85%	155193	1520	6,10	MPC-HP-1400	1.400	10° - 34°	63507	540	2,16	1500	4	7,5 - 55 kW	55% - 85%	193156	1550	6,22																																
MPC-HP-630	630	10° - 34°	6914	156	0,62	3000/1500	2/4	0,75 - 18,5 kW	55% - 85%																																																																																																																																								
			37732	2350	9,43					MPC-HP-710	710	10° - 34°	9970	171	0,68	3000/1500	2/4	0,75 - 37 kW	55% - 85%	56302	2650	10,63	MPC-HP-800	800	10° - 34°	12993	183	0,73	3000/1500	2/4	0,75 - 37 kW	55% - 85%	71464	3250	13,04	MPC-HP-900	900	10° - 34°	16887	203	0,81	1500	4	0,75 - 22 kW	55% - 85%	59651	1050	4,21	MPC-HP-1000	1.000	10° - 34°	24043	301	1,20	1500	4	1,5 - 30 kW	55% - 85%	81061	1250	5,01	MPC-HP-1120	1120	10° - 34°	39166	600	2,40	1500	4	4 - 45 kW	55% - 85%	111967	1280	5,13	MPC-HP-1250	1.250	10° - 34°	51126	709	2,84	1500	4	5,5 - 55 kW	55% - 85%	155193	1520	6,10	MPC-HP-1400	1.400	10° - 34°	63507	540	2,16	1500	4	7,5 - 55 kW	55% - 85%	193156	1550	6,22																																													
MPC-HP-710	710	10° - 34°	9970	171	0,68	3000/1500	2/4	0,75 - 37 kW	55% - 85%																																																																																																																																								
			56302	2650	10,63					MPC-HP-800	800	10° - 34°	12993	183	0,73	3000/1500	2/4	0,75 - 37 kW	55% - 85%	71464	3250	13,04	MPC-HP-900	900	10° - 34°	16887	203	0,81	1500	4	0,75 - 22 kW	55% - 85%	59651	1050	4,21	MPC-HP-1000	1.000	10° - 34°	24043	301	1,20	1500	4	1,5 - 30 kW	55% - 85%	81061	1250	5,01	MPC-HP-1120	1120	10° - 34°	39166	600	2,40	1500	4	4 - 45 kW	55% - 85%	111967	1280	5,13	MPC-HP-1250	1.250	10° - 34°	51126	709	2,84	1500	4	5,5 - 55 kW	55% - 85%	155193	1520	6,10	MPC-HP-1400	1.400	10° - 34°	63507	540	2,16	1500	4	7,5 - 55 kW	55% - 85%	193156	1550	6,22																																																										
MPC-HP-800	800	10° - 34°	12993	183	0,73	3000/1500	2/4	0,75 - 37 kW	55% - 85%																																																																																																																																								
			71464	3250	13,04					MPC-HP-900	900	10° - 34°	16887	203	0,81	1500	4	0,75 - 22 kW	55% - 85%	59651	1050	4,21	MPC-HP-1000	1.000	10° - 34°	24043	301	1,20	1500	4	1,5 - 30 kW	55% - 85%	81061	1250	5,01	MPC-HP-1120	1120	10° - 34°	39166	600	2,40	1500	4	4 - 45 kW	55% - 85%	111967	1280	5,13	MPC-HP-1250	1.250	10° - 34°	51126	709	2,84	1500	4	5,5 - 55 kW	55% - 85%	155193	1520	6,10	MPC-HP-1400	1.400	10° - 34°	63507	540	2,16	1500	4	7,5 - 55 kW	55% - 85%	193156	1550	6,22																																																																							
MPC-HP-900	900	10° - 34°	16887	203	0,81	1500	4	0,75 - 22 kW	55% - 85%																																																																																																																																								
			59651	1050	4,21					MPC-HP-1000	1.000	10° - 34°	24043	301	1,20	1500	4	1,5 - 30 kW	55% - 85%	81061	1250	5,01	MPC-HP-1120	1120	10° - 34°	39166	600	2,40	1500	4	4 - 45 kW	55% - 85%	111967	1280	5,13	MPC-HP-1250	1.250	10° - 34°	51126	709	2,84	1500	4	5,5 - 55 kW	55% - 85%	155193	1520	6,10	MPC-HP-1400	1.400	10° - 34°	63507	540	2,16	1500	4	7,5 - 55 kW	55% - 85%	193156	1550	6,22																																																																																				
MPC-HP-1000	1.000	10° - 34°	24043	301	1,20	1500	4	1,5 - 30 kW	55% - 85%																																																																																																																																								
			81061	1250	5,01					MPC-HP-1120	1120	10° - 34°	39166	600	2,40	1500	4	4 - 45 kW	55% - 85%	111967	1280	5,13	MPC-HP-1250	1.250	10° - 34°	51126	709	2,84	1500	4	5,5 - 55 kW	55% - 85%	155193	1520	6,10	MPC-HP-1400	1.400	10° - 34°	63507	540	2,16	1500	4	7,5 - 55 kW	55% - 85%	193156	1550	6,22																																																																																																	
MPC-HP-1120	1120	10° - 34°	39166	600	2,40	1500	4	4 - 45 kW	55% - 85%																																																																																																																																								
			111967	1280	5,13					MPC-HP-1250	1.250	10° - 34°	51126	709	2,84	1500	4	5,5 - 55 kW	55% - 85%	155193	1520	6,10	MPC-HP-1400	1.400	10° - 34°	63507	540	2,16	1500	4	7,5 - 55 kW	55% - 85%	193156	1550	6,22																																																																																																														
MPC-HP-1250	1.250	10° - 34°	51126	709	2,84	1500	4	5,5 - 55 kW	55% - 85%																																																																																																																																								
			155193	1520	6,10					MPC-HP-1400	1.400	10° - 34°	63507	540	2,16	1500	4	7,5 - 55 kW	55% - 85%	193156	1550	6,22																																																																																																																											
MPC-HP-1400	1.400	10° - 34°	63507	540	2,16	1500	4	7,5 - 55 kW	55% - 85%																																																																																																																																								
			193156	1550	6,22																																																																																																																																												

*data represent the range of values for each diameter



INDUSTRIAL VENTILATION

MPC-HP RANGE

TECHNICAL DATA*

PRODUCTS	DIAM. Ø	BLADE ANGLE MIN/MAX	FLOW RATE (M ³ /H) MIN/MAX FLOW @ 0 Pa	STATIC RESSURE RANGE (Pa) MIN/MAX	STATIC PRESSURE RANGE (Pa) WATER INCHS MIN/MAX	SPEED (RPM) MIN/MAX	N° OF POLES MIN/MAX	POWER RANGE (kW) MIN/MAX	TOTAL EFFICIENCY % MIN/MAX																																																																																																																																								
MPC-HP-400	400	10° - 34°	920	23	0,09	3000/1500 1500/750	2/4 4/8	0,15 - 2,2 kW	55% - 85%																																																																																																																																								
			9559	869	3,48					MPC-HP-450	450	10° - 34°	1390	28	0,11	3000/1500 1500/750	2/4 4/8	0,15 - 3,1 kW	55% - 85%	13438	686	2,75	MPC-HP-500	500	10° - 34°	1812	29	0,11	3000/1500 1500/750	2/4 4/8	0,15 - 4,4 kW	55% - 85%	92248	1.092	4,38	MPC-HP-560	560	10° - 34°	2222	36	0,14	3000/1500 1500/750	2/4 4/8	0,3 - 8 kW	55% - 85%	26344	1.615	6,48	MPC-HP-630	630	10° - 34°	3276	63	0,25	3000/1500 1500/750	2/4 4/8	0,3 - 16 kW	55% - 85%	186180	2.350	9,43	MPC-HP-710	710	10° - 34°	4512	42	0,16	3000/1500 1500/750	2/4 4/8	0,15 - 33 kW	55% - 85%	53864	2.698	10,83	MPC-HP-800	800	10° - 34°	5950	44	0,17	3000/1500 1500/750	2/4 4/8	0,15 - 33 kW	55% - 85%	66708	3.280	13,16	MPC-HP-900	900	10° - 34°	7778	52	0,20	1500/750	4/8	0,2 - 17 kW	55% - 85%	59534	1.075	4,31	MPC-HP-1000	1.000	10° - 34°	11154	74	0,29	1500/750	4/8	0,4 - 28 kW	55% - 85%	80790	1.253	5,03	MPC-HP-1120	1.120	10° - 34°	18942	118	0,47	1500/750	4/8	1,8 - 35 kW	55% - 85%	111790	1.301	5,22	MPC-HP-1250	1.250	10° - 34°	24868	132	0,52	1500/750	4/8	3 - 55 kW	55% - 85%	154908	1.546	6,20	MPC-HP-1400	1.400	10° - 34°	30984	135	4,55
MPC-HP-450	450	10° - 34°	1390	28	0,11	3000/1500 1500/750	2/4 4/8	0,15 - 3,1 kW	55% - 85%																																																																																																																																								
			13438	686	2,75					MPC-HP-500	500	10° - 34°	1812	29	0,11	3000/1500 1500/750	2/4 4/8	0,15 - 4,4 kW	55% - 85%	92248	1.092	4,38	MPC-HP-560	560	10° - 34°	2222	36	0,14	3000/1500 1500/750	2/4 4/8	0,3 - 8 kW	55% - 85%	26344	1.615	6,48	MPC-HP-630	630	10° - 34°	3276	63	0,25	3000/1500 1500/750	2/4 4/8	0,3 - 16 kW	55% - 85%	186180	2.350	9,43	MPC-HP-710	710	10° - 34°	4512	42	0,16	3000/1500 1500/750	2/4 4/8	0,15 - 33 kW	55% - 85%	53864	2.698	10,83	MPC-HP-800	800	10° - 34°	5950	44	0,17	3000/1500 1500/750	2/4 4/8	0,15 - 33 kW	55% - 85%	66708	3.280	13,16	MPC-HP-900	900	10° - 34°	7778	52	0,20	1500/750	4/8	0,2 - 17 kW	55% - 85%	59534	1.075	4,31	MPC-HP-1000	1.000	10° - 34°	11154	74	0,29	1500/750	4/8	0,4 - 28 kW	55% - 85%	80790	1.253	5,03	MPC-HP-1120	1.120	10° - 34°	18942	118	0,47	1500/750	4/8	1,8 - 35 kW	55% - 85%	111790	1.301	5,22	MPC-HP-1250	1.250	10° - 34°	24868	132	0,52	1500/750	4/8	3 - 55 kW	55% - 85%	154908	1.546	6,20	MPC-HP-1400	1.400	10° - 34°	30984	135	4,55	1500/750	4/8	3,5 - 55 kW	55% - 85%	188 164	1.598	6,41						
MPC-HP-500	500	10° - 34°	1812	29	0,11	3000/1500 1500/750	2/4 4/8	0,15 - 4,4 kW	55% - 85%																																																																																																																																								
			92248	1.092	4,38					MPC-HP-560	560	10° - 34°	2222	36	0,14	3000/1500 1500/750	2/4 4/8	0,3 - 8 kW	55% - 85%	26344	1.615	6,48	MPC-HP-630	630	10° - 34°	3276	63	0,25	3000/1500 1500/750	2/4 4/8	0,3 - 16 kW	55% - 85%	186180	2.350	9,43	MPC-HP-710	710	10° - 34°	4512	42	0,16	3000/1500 1500/750	2/4 4/8	0,15 - 33 kW	55% - 85%	53864	2.698	10,83	MPC-HP-800	800	10° - 34°	5950	44	0,17	3000/1500 1500/750	2/4 4/8	0,15 - 33 kW	55% - 85%	66708	3.280	13,16	MPC-HP-900	900	10° - 34°	7778	52	0,20	1500/750	4/8	0,2 - 17 kW	55% - 85%	59534	1.075	4,31	MPC-HP-1000	1.000	10° - 34°	11154	74	0,29	1500/750	4/8	0,4 - 28 kW	55% - 85%	80790	1.253	5,03	MPC-HP-1120	1.120	10° - 34°	18942	118	0,47	1500/750	4/8	1,8 - 35 kW	55% - 85%	111790	1.301	5,22	MPC-HP-1250	1.250	10° - 34°	24868	132	0,52	1500/750	4/8	3 - 55 kW	55% - 85%	154908	1.546	6,20	MPC-HP-1400	1.400	10° - 34°	30984	135	4,55	1500/750	4/8	3,5 - 55 kW	55% - 85%	188 164	1.598	6,41																			
MPC-HP-560	560	10° - 34°	2222	36	0,14	3000/1500 1500/750	2/4 4/8	0,3 - 8 kW	55% - 85%																																																																																																																																								
			26344	1.615	6,48					MPC-HP-630	630	10° - 34°	3276	63	0,25	3000/1500 1500/750	2/4 4/8	0,3 - 16 kW	55% - 85%	186180	2.350	9,43	MPC-HP-710	710	10° - 34°	4512	42	0,16	3000/1500 1500/750	2/4 4/8	0,15 - 33 kW	55% - 85%	53864	2.698	10,83	MPC-HP-800	800	10° - 34°	5950	44	0,17	3000/1500 1500/750	2/4 4/8	0,15 - 33 kW	55% - 85%	66708	3.280	13,16	MPC-HP-900	900	10° - 34°	7778	52	0,20	1500/750	4/8	0,2 - 17 kW	55% - 85%	59534	1.075	4,31	MPC-HP-1000	1.000	10° - 34°	11154	74	0,29	1500/750	4/8	0,4 - 28 kW	55% - 85%	80790	1.253	5,03	MPC-HP-1120	1.120	10° - 34°	18942	118	0,47	1500/750	4/8	1,8 - 35 kW	55% - 85%	111790	1.301	5,22	MPC-HP-1250	1.250	10° - 34°	24868	132	0,52	1500/750	4/8	3 - 55 kW	55% - 85%	154908	1.546	6,20	MPC-HP-1400	1.400	10° - 34°	30984	135	4,55	1500/750	4/8	3,5 - 55 kW	55% - 85%	188 164	1.598	6,41																																
MPC-HP-630	630	10° - 34°	3276	63	0,25	3000/1500 1500/750	2/4 4/8	0,3 - 16 kW	55% - 85%																																																																																																																																								
			186180	2.350	9,43					MPC-HP-710	710	10° - 34°	4512	42	0,16	3000/1500 1500/750	2/4 4/8	0,15 - 33 kW	55% - 85%	53864	2.698	10,83	MPC-HP-800	800	10° - 34°	5950	44	0,17	3000/1500 1500/750	2/4 4/8	0,15 - 33 kW	55% - 85%	66708	3.280	13,16	MPC-HP-900	900	10° - 34°	7778	52	0,20	1500/750	4/8	0,2 - 17 kW	55% - 85%	59534	1.075	4,31	MPC-HP-1000	1.000	10° - 34°	11154	74	0,29	1500/750	4/8	0,4 - 28 kW	55% - 85%	80790	1.253	5,03	MPC-HP-1120	1.120	10° - 34°	18942	118	0,47	1500/750	4/8	1,8 - 35 kW	55% - 85%	111790	1.301	5,22	MPC-HP-1250	1.250	10° - 34°	24868	132	0,52	1500/750	4/8	3 - 55 kW	55% - 85%	154908	1.546	6,20	MPC-HP-1400	1.400	10° - 34°	30984	135	4,55	1500/750	4/8	3,5 - 55 kW	55% - 85%	188 164	1.598	6,41																																													
MPC-HP-710	710	10° - 34°	4512	42	0,16	3000/1500 1500/750	2/4 4/8	0,15 - 33 kW	55% - 85%																																																																																																																																								
			53864	2.698	10,83					MPC-HP-800	800	10° - 34°	5950	44	0,17	3000/1500 1500/750	2/4 4/8	0,15 - 33 kW	55% - 85%	66708	3.280	13,16	MPC-HP-900	900	10° - 34°	7778	52	0,20	1500/750	4/8	0,2 - 17 kW	55% - 85%	59534	1.075	4,31	MPC-HP-1000	1.000	10° - 34°	11154	74	0,29	1500/750	4/8	0,4 - 28 kW	55% - 85%	80790	1.253	5,03	MPC-HP-1120	1.120	10° - 34°	18942	118	0,47	1500/750	4/8	1,8 - 35 kW	55% - 85%	111790	1.301	5,22	MPC-HP-1250	1.250	10° - 34°	24868	132	0,52	1500/750	4/8	3 - 55 kW	55% - 85%	154908	1.546	6,20	MPC-HP-1400	1.400	10° - 34°	30984	135	4,55	1500/750	4/8	3,5 - 55 kW	55% - 85%	188 164	1.598	6,41																																																										
MPC-HP-800	800	10° - 34°	5950	44	0,17	3000/1500 1500/750	2/4 4/8	0,15 - 33 kW	55% - 85%																																																																																																																																								
			66708	3.280	13,16					MPC-HP-900	900	10° - 34°	7778	52	0,20	1500/750	4/8	0,2 - 17 kW	55% - 85%	59534	1.075	4,31	MPC-HP-1000	1.000	10° - 34°	11154	74	0,29	1500/750	4/8	0,4 - 28 kW	55% - 85%	80790	1.253	5,03	MPC-HP-1120	1.120	10° - 34°	18942	118	0,47	1500/750	4/8	1,8 - 35 kW	55% - 85%	111790	1.301	5,22	MPC-HP-1250	1.250	10° - 34°	24868	132	0,52	1500/750	4/8	3 - 55 kW	55% - 85%	154908	1.546	6,20	MPC-HP-1400	1.400	10° - 34°	30984	135	4,55	1500/750	4/8	3,5 - 55 kW	55% - 85%	188 164	1.598	6,41																																																																							
MPC-HP-900	900	10° - 34°	7778	52	0,20	1500/750	4/8	0,2 - 17 kW	55% - 85%																																																																																																																																								
			59534	1.075	4,31					MPC-HP-1000	1.000	10° - 34°	11154	74	0,29	1500/750	4/8	0,4 - 28 kW	55% - 85%	80790	1.253	5,03	MPC-HP-1120	1.120	10° - 34°	18942	118	0,47	1500/750	4/8	1,8 - 35 kW	55% - 85%	111790	1.301	5,22	MPC-HP-1250	1.250	10° - 34°	24868	132	0,52	1500/750	4/8	3 - 55 kW	55% - 85%	154908	1.546	6,20	MPC-HP-1400	1.400	10° - 34°	30984	135	4,55	1500/750	4/8	3,5 - 55 kW	55% - 85%	188 164	1.598	6,41																																																																																				
MPC-HP-1000	1.000	10° - 34°	11154	74	0,29	1500/750	4/8	0,4 - 28 kW	55% - 85%																																																																																																																																								
			80790	1.253	5,03					MPC-HP-1120	1.120	10° - 34°	18942	118	0,47	1500/750	4/8	1,8 - 35 kW	55% - 85%	111790	1.301	5,22	MPC-HP-1250	1.250	10° - 34°	24868	132	0,52	1500/750	4/8	3 - 55 kW	55% - 85%	154908	1.546	6,20	MPC-HP-1400	1.400	10° - 34°	30984	135	4,55	1500/750	4/8	3,5 - 55 kW	55% - 85%	188 164	1.598	6,41																																																																																																	
MPC-HP-1120	1.120	10° - 34°	18942	118	0,47	1500/750	4/8	1,8 - 35 kW	55% - 85%																																																																																																																																								
			111790	1.301	5,22					MPC-HP-1250	1.250	10° - 34°	24868	132	0,52	1500/750	4/8	3 - 55 kW	55% - 85%	154908	1.546	6,20	MPC-HP-1400	1.400	10° - 34°	30984	135	4,55	1500/750	4/8	3,5 - 55 kW	55% - 85%	188 164	1.598	6,41																																																																																																														
MPC-HP-1250	1.250	10° - 34°	24868	132	0,52	1500/750	4/8	3 - 55 kW	55% - 85%																																																																																																																																								
			154908	1.546	6,20					MPC-HP-1400	1.400	10° - 34°	30984	135	4,55	1500/750	4/8	3,5 - 55 kW	55% - 85%	188 164	1.598	6,41																																																																																																																											
MPC-HP-1400	1.400	10° - 34°	30984	135	4,55	1500/750	4/8	3,5 - 55 kW	55% - 85%																																																																																																																																								
			188 164	1.598	6,41																																																																																																																																												

*data represent the range of values for each diameter



DIMENSIONS

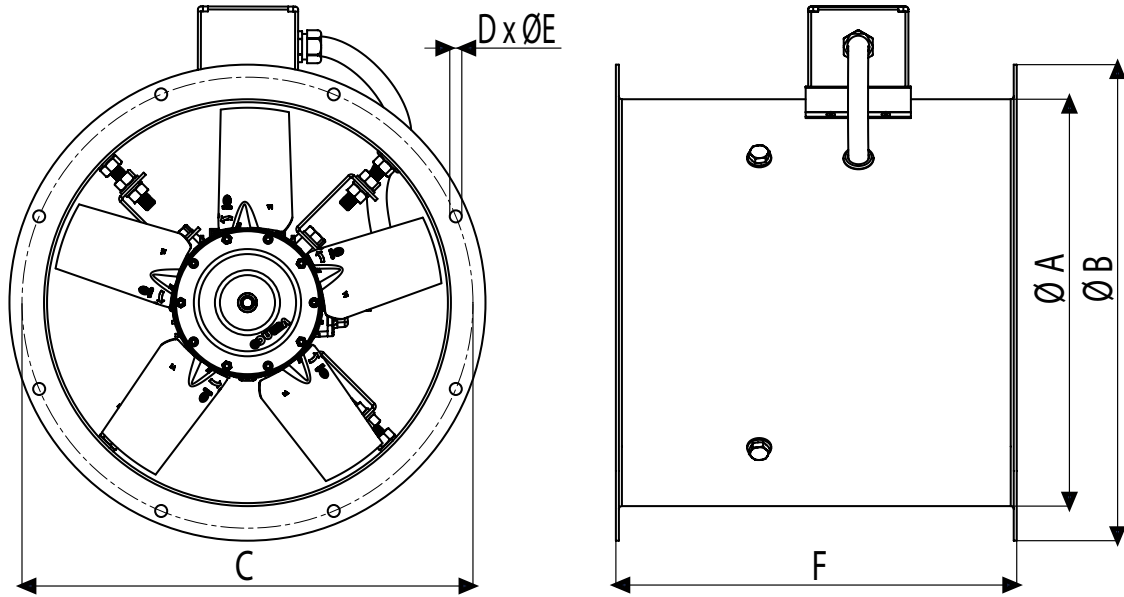

FAN	MOTOR FRAME	Ø A	Ø B	Ø C	D X Ø E	F
400	80	400	475	450	8xØ12	400
	90					
500	80	500	580	560	12xØ12	400
	90					450
	100					
560	80	560	645	620	12xØ12	400
	90					450
	100					570
	112					
	132					
630	80	630	715	690	12xØ12	400
	90					450
	100					570
	112					710
	132					
710	160	800	885	860	16xØ12	450
	80					570
	112					710
	132					790
	160					840
800	180	800	885	860	16xØ12	450
	200					570
	80					710
	112					790
	132					840

Dimensions (mm)



DIMENSIONS

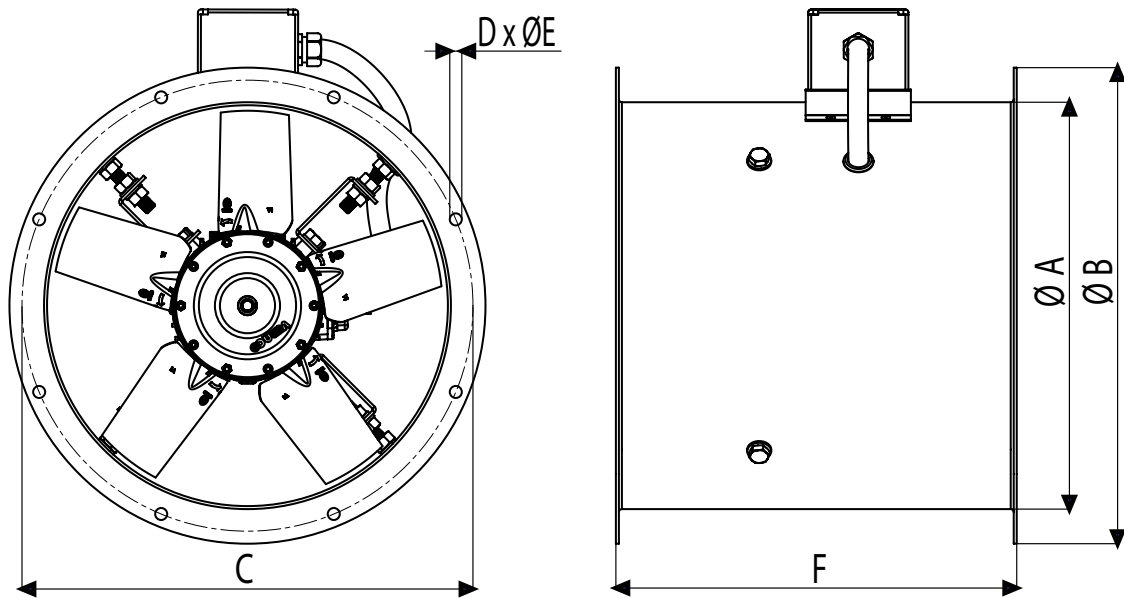

FAN	MOTOR FRAME	Ø A	Ø B	Ø C	D X Ø E	F
900	80	900	1000	970	16xØ12	450
	112					570
	132					710
	160					790
	180					
1000	80	1000	1110	1070	16xØ15	450
	112					590
	132					790
	160					840
	180					840
1120	200	1120	1240	1190	20xØ15	590
	100					790
	132					840
	160					1000
	180					
1250	225	1250	1380	1320	20xØ15	590
	100					790
	132					840
	160					1000
	180					1100
1400	250	1400	1540	1470	20xØ15	590
	132					790
	160					840
	180					1000
	200					1100
	225					1100
	250					

Dimensions (mm)



SOFTWARE

Fan Selection

VORTICE Fan selection allows customers the ability to select the right fan starting from the duty point (flow rate and static pressure) in case MPC HP and MPC ED. The fan selection process has been designed for an easy use.

Fans can be selected from categories ranging from “MPC HP” to “MPC ED” to "VORT JET". These categories can be further broken down into diameter, prices and efficiency.

Once the product category/type are selected and the operating conditions are entered, the program searches across all available products to meet the selection criteria. Once a fan is selected, the user has the option to view its technical data, its performance curve (if any) and its identification code, print the results or save the selection for future uses. In addition, he can create a drawing for the selected fan. The software allows the user to specify a very detailed list of input data and parameters. It enables also a very detailed and specific selection, giving the user the possibility to specify a wide range of information for the fans to be selected. In a very quick and straightforward way, the software propose a set of fans that match the input criteria.

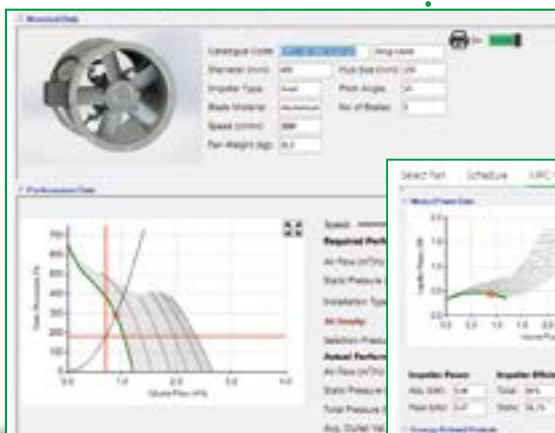
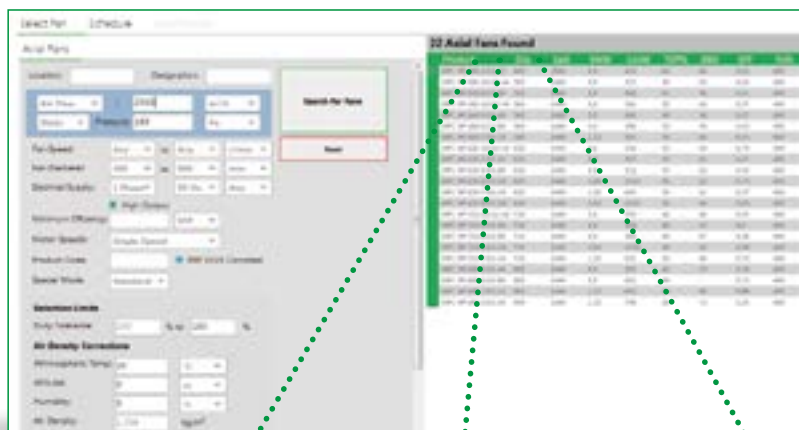



ACCESSORIES MPC-ED | MPC-HP

MODELS	DESCRIPTION	Ø MPC	CODE	PRODUCTS
		400	21238	SLE 1D 400
		400	21343	SLE 1D 800
		450	21226	SLE 1D 450
		450	21331	SLE 2D 450
		500	21239	SLE 1D 500
		500	21344	SLE 2D 500
		560	21240	SLE 1D 560
		560	21345	SLE 2D 560
		630	21241	SLE 1D 630
		630	21346	SLE 2D 630
		710	21242	SLE 1D 710
		710	21347	SLE 2D 710
		800	21243	SLE 1D 800
		800	21348	SLE 2D 800
		900	21244	SLE 1D 900
		900	21349	SLE 2D 900
		1000	21245	SLE 1D 1000
		1000	21350	SLE 2D 1000
		1120	21246	SLE 1D 1120
		1120	21351	SLE 2D 1120
		1250	21247	SLE 1D 1250
		1250	21352	SLE 2D 1250
		1400	21248	SLE 1D 1400
		1400	21353	SLE 2D 1400



SLE -- Silencers



ACCESSORIES MPC-ED | MPC-HP

MODELS	DESCRIPTION	Ø MPC	CODE	PRODUCTS
		400	21225	SLE-P 1D 400
		400	21320	SLE-P 2D 400
		450	21227	SLE-P 1D 450
		450	21332	SLE-P 2D 450
		500	21228	SLE-P 1D 500
		500	21333	SLE-P 2D 500
		560	21229	SLE-P 1D 560
		560	21334	SLE-P 2D 560
		630	21230	SLE-P 1D 630
		630	21335	SLE-P 2D 630
		710	21231	SLE-P 1D 710
		710	21336	SLE-P 2D 710
		800	21232	SLE-P 1D 800
		800	21337	SLE-P 2D 800
		900	21233	SLE-P 1D 900
		900	21338	SLE-P 2D 900
		1000	21234	SLE-P 1D 1000
		1000	21339	SLE-P 2D 1000
		1120	21235	SLE-P 1D 1120
		1120	21340	SLE-P 2D 1120
		1250	21236	SLE-P 1D 1250
		1250	21341	SLE-P 2D 1250
		1400	21237	SLE-P 1D 1400
		1400	21342	SLE-P 2D 1400



SLE-P - Silencers with pod

MODELS	DESCRIPTION	CODE	PRODUCTS	NOTE
		21251	XS-12/50	MAXIMUM LOAD: 50 KG
		21252	XS-13/75	MAXIMUM LOAD: 75 KG
		21253	XS-14/125	MAXIMUM LOAD: 125 KG
		21254	XS-16/175	MAXIMUM LOAD: 125 KG
		21255	XS-17/200	MAXIMUM LOAD: 200 KG



XS - Enclosed spring anti-vibration mounts



ACCESSORIES MPC-ED | MPC-HP

MODELS	DESCRIPTION	Ø MPC	CODE	PRODUCTS
	MFL - Galvanized counter flanges	400	21256	MFL 400
		450	21257	MFL 450
		500	21258	MFL 500
		560	21259	MFL 560
		630	21260	MFL 630
		710	21261	MFL 710
		800	21262	MFL 800
		900	21263	MFL 900
		1000	21264	MFL 1000
		1120	21265	MFL 1120
		1250	21266	MFL 1250
		1400	21267	MFL 1400

MODELS	DESCRIPTION	Ø MPC	CODE	PRODUCTS
	MSC - Galvanized wire guard	400	21268	MSC 400
		450	21502	MSC 450
		500	21503	MSC 500
		560	21504	MSC 560
		630	21505	MSC 630
		710	21506	MSC 710
		800	21507	MSC 800
		900	21508	MSC 900
		1000	21509	MSC 1000
		1120	21510	MSC 1120
		1250	21511	MSC 1250
		1400	21512	MSC 1400



ACCESSORIES MPC-ED | MPC-HP

MODELS	DESCRIPTION	Ø MPC	CODE	PRODUCTS
		400	21309	EBY 400
		450	21513	EBY 450
		500	21310	EBY 500
		560	21311	EBY 560
		630	21312	EBY 630
		710	21313	EBY 710
		800	21314	EBY 800
		900	21315	EBY 900
		1000	21316	EBY 1000
		1120	21317	EBY 1120
		1250	21318	EBY 1250
		1400	21319	EBY 1400



EBY - Circular flexible connections, resistant up to 70 °C.

MODELS	DESCRIPTION	Ø MPC	CODE	PRODUCTS
		400	21526	MSC 400
		450	21527	MSC 450
		500	21528	MSC 500
		560	21529	MSC 560
		630	21530	MSC 630
		710	21531	MSC 710
		800	21532	MSC 800
		900	21533	MSC 900
		1000	21534	MSC 1000
		1120	21535	MSC 1120
		1250	21536	MSC 1250
		1400	21537	MSC 1400

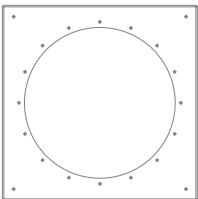

MPT - Mounting plate.



ACCESSORI COMUNI MPC-ED | MPC-HP

MODELS	DESCRIPTION	Ø MPC	CODE	PRODUCTS
		400	21309	MFT 400
		450	21513	MFT 450
		500	21310	MFT 500
		560	21311	MFT 560
		630	21312	MFT 630
		710	21313	MFT 710
		800	21314	MFT 800
		900	21315	MFT 900
		1000	21316	MFT 1000
		1120	21317	MFT 1120
		1250	21318	MFT 1250
		1400	21319	MFT 1400



MFT - Mounting brackets made of hot-dip galvanized steel.

MODELS	DESCRIPTION	Ø MPC	CODE	PRODUCTS
		400	21281	MFT-C 400
		450	21282	MFT-C 450
		500	21283	MFT-C 500
		560	21284	MFT-C 560
		630	21285	MFT-C 630
		710	21289	MFT-C 710
		800	21287	MFT-C 800
		900	21288	MFT-C 900
		1000	21289	MFT-C 1000
		1120	21290	MFT-C 1120
		1250	21291	MFT-C 1250
		1400	21292	MFT-C 1400



MFT-C - Mounting brackets made of epoxy coated steel.



ACCESSORI COMUNI MPC-ED | MPC-HP

MODELS	DESCRIPTION	Ø MPC	CODE	PRODUCTS
	NRDO - Axial fans for round back draft. Galvanised steel casing and alluminum damper.	400	21514	NRDO 400
		450	21515	NRDO 450
		500	21516	NRDO 500
		560	21517	NRDO 560
		630	21518	NRDO 630
		710	21519	NRDO 710
		800	21520	NRDO 800
		900	21521	NRDO 900
		1000	21522	NRDO 1000
		1120	21523	NRDO 1120
		1250	21524	NRDO 1250
		1400	21525	NRDO 1400

MODELS	DESCRIPTION	CODE	PRODUCTS
	IRET INVERTER - Frequency inverter.	12909	IRET INVERTER 1.2
		12925	IRET INVERTER 2.2
		12947	IRET INVERTER 5
		12989	IRET INVERTER 8



MPC-ED F400 RANGE MPC ED SC F400 RANGE



Fully and short cased axial fans

MPC ED F400 and MPC ED SC F400 are dual role (ventilation and hot fumes extraction), axial flow fans, all certified F400/120 according to EN 12101-3 standard and compliant with ErP Reg. N° 327/2011/UE, which combine huge performances with high efficiencies.

Key features

- Reinforced sheet metal casings, epoxy powder coated, for a long lasting protection against corrosion. Casings of MPC ED F400 with motor access door for easy connection.
- Die-casted impellers; aerofoil-shaped blades to combine high efficiency and low noise; manually adjustable blade pitch.
- Three-phase, 230/400 V / 50 Hz (400/690 V / 50 Hz for higher powers), H class insulated, IP55 protected motors, available in 2 poles (only for MPC ED F400) 4 poles, 6 poles, 2/4, 4/6 and 4/8 poles (Dahlander) versions. Speed adjustable through frequency inverters (available as option).

Versions

Given the large number of alternative models, it has been decided not to proceed with encoding the entire range. The identification of units able to meet specific performance / functional needs will be granted through a dedicated Fan Selector.

Technical features

- MPC ED SC F400 range consists of short casing fans, while MPC ED F400 of long casing units. Both ranges are equipped with dynamically balanced supply (air direction from impeller to motor) impellers to minimize vibration levels and assure smooth operation; blade pitch angles can be manually adjusted to offer performance flexibility.
- Compatible with both horizontal and (for models up to 900 mm of diameter vertical installation, fans of MPC ED F400 and MPC ED SC F400 range have been designed to meet the ventilation requirements of large commercial and industrial environments.
- Both range consists of 11 (from 400 mm to 1.250 mm), nominal diameters; airflows are up to 135.000 m³/h (37,5 m³/s).
- Each diameter is provided in a number of variants, including different number and pitch angles, sizes and number of poles of the motors and lengths of the casings, so as to cover a wide range of application needs.

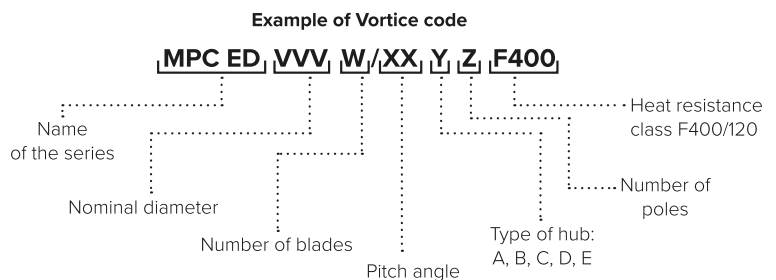
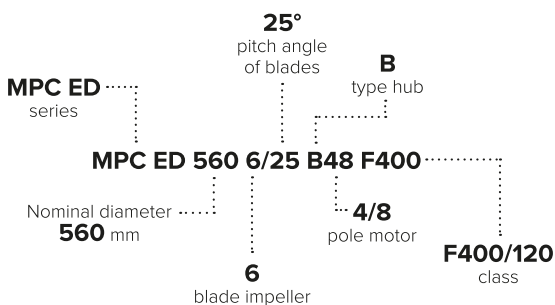



TECHNICAL DATA*

PRODUCTS	DIAM. Ø	BLADE ANGLE MIN/MAX	FLOW RATE (M ³ /H) MIN/MAX FLOW @ 0 Pa	STATIC RESSURE RANGE (Pa) MIN/MAX	STATIC PRESSURE RANGE (Pa) WATER INCHS MIN/MAX	SPEED (RPM) MIN/MAX	N° OF POLES MIN/MAX	POWER RANGE (kW) MIN/MAX	TOTAL EFFICIENCY % MIN/MAX																																																																																																														
MPC ED 450 F400**	450	20° - 45°	2.756	55	0,22	3000/1000	2/6	0,55 - 3	38% - 55%																																																																																																														
			12.400	938	3,76					MPC ED 500 F400**	500	20° - 45°	3.971	62	0,24	3000/1000	2/6	0,55 - 4	44% - 56%	16.200	1.062	4,26	MPC ED 560 F400**	560	20° - 45°	4.780	114	0,45	3000/1000	2/6	0,55 - 7,5	54% - 79%	24.800	1.200	4,81	MPC ED 630 F400	630	20° - 45°	6.635	135	0,54	1500/1000	4/6	0,75 - 7,5	65% - 81%	20.340	380	1,52	MPC ED 710 F400	710	20° - 45°	9.038	143	0,57	1500/1000	4/6	0,55 - 3	66% - 77%	27.510	438	1,75	MPC ED 800 F400	800	20° - 45°	10.900	135	0,54	1500/1000	4/6	0,75 - 4	64% - 80%	34.460	562	2,25	MPC ED 900 F400	900	20° - 42°	16.200	175	0,70	1500/1000	4/6	1,5 - 15	56% - 67%	54.810	850	3,41	MPC ED 1000 F400	1.000	20° - 42°	23.850	176	0,70	1500/1000	4/6	1,5 - 22	64% - 75%	77.810	1.021	4,09	MPC ED 1120 F400	1.120	20° - 42°	32.520	160	0,64	1500/1000	4/6	2,2 - 37	66% - 76%	104.010	1.080	4,33	MPC ED 1250 F400	1.250	20° - 42°	44.030	188	0,75
MPC ED 500 F400**	500	20° - 45°	3.971	62	0,24	3000/1000	2/6	0,55 - 4	44% - 56%																																																																																																														
			16.200	1.062	4,26					MPC ED 560 F400**	560	20° - 45°	4.780	114	0,45	3000/1000	2/6	0,55 - 7,5	54% - 79%	24.800	1.200	4,81	MPC ED 630 F400	630	20° - 45°	6.635	135	0,54	1500/1000	4/6	0,75 - 7,5	65% - 81%	20.340	380	1,52	MPC ED 710 F400	710	20° - 45°	9.038	143	0,57	1500/1000	4/6	0,55 - 3	66% - 77%	27.510	438	1,75	MPC ED 800 F400	800	20° - 45°	10.900	135	0,54	1500/1000	4/6	0,75 - 4	64% - 80%	34.460	562	2,25	MPC ED 900 F400	900	20° - 42°	16.200	175	0,70	1500/1000	4/6	1,5 - 15	56% - 67%	54.810	850	3,41	MPC ED 1000 F400	1.000	20° - 42°	23.850	176	0,70	1500/1000	4/6	1,5 - 22	64% - 75%	77.810	1.021	4,09	MPC ED 1120 F400	1.120	20° - 42°	32.520	160	0,64	1500/1000	4/6	2,2 - 37	66% - 76%	104.010	1.080	4,33	MPC ED 1250 F400	1.250	20° - 42°	44.030	188	0,75	1500/1000	4/6	3 - 45	65% - 75%	141.010	1.280	5,13						
MPC ED 560 F400**	560	20° - 45°	4.780	114	0,45	3000/1000	2/6	0,55 - 7,5	54% - 79%																																																																																																														
			24.800	1.200	4,81					MPC ED 630 F400	630	20° - 45°	6.635	135	0,54	1500/1000	4/6	0,75 - 7,5	65% - 81%	20.340	380	1,52	MPC ED 710 F400	710	20° - 45°	9.038	143	0,57	1500/1000	4/6	0,55 - 3	66% - 77%	27.510	438	1,75	MPC ED 800 F400	800	20° - 45°	10.900	135	0,54	1500/1000	4/6	0,75 - 4	64% - 80%	34.460	562	2,25	MPC ED 900 F400	900	20° - 42°	16.200	175	0,70	1500/1000	4/6	1,5 - 15	56% - 67%	54.810	850	3,41	MPC ED 1000 F400	1.000	20° - 42°	23.850	176	0,70	1500/1000	4/6	1,5 - 22	64% - 75%	77.810	1.021	4,09	MPC ED 1120 F400	1.120	20° - 42°	32.520	160	0,64	1500/1000	4/6	2,2 - 37	66% - 76%	104.010	1.080	4,33	MPC ED 1250 F400	1.250	20° - 42°	44.030	188	0,75	1500/1000	4/6	3 - 45	65% - 75%	141.010	1.280	5,13																			
MPC ED 630 F400	630	20° - 45°	6.635	135	0,54	1500/1000	4/6	0,75 - 7,5	65% - 81%																																																																																																														
			20.340	380	1,52					MPC ED 710 F400	710	20° - 45°	9.038	143	0,57	1500/1000	4/6	0,55 - 3	66% - 77%	27.510	438	1,75	MPC ED 800 F400	800	20° - 45°	10.900	135	0,54	1500/1000	4/6	0,75 - 4	64% - 80%	34.460	562	2,25	MPC ED 900 F400	900	20° - 42°	16.200	175	0,70	1500/1000	4/6	1,5 - 15	56% - 67%	54.810	850	3,41	MPC ED 1000 F400	1.000	20° - 42°	23.850	176	0,70	1500/1000	4/6	1,5 - 22	64% - 75%	77.810	1.021	4,09	MPC ED 1120 F400	1.120	20° - 42°	32.520	160	0,64	1500/1000	4/6	2,2 - 37	66% - 76%	104.010	1.080	4,33	MPC ED 1250 F400	1.250	20° - 42°	44.030	188	0,75	1500/1000	4/6	3 - 45	65% - 75%	141.010	1.280	5,13																																
MPC ED 710 F400	710	20° - 45°	9.038	143	0,57	1500/1000	4/6	0,55 - 3	66% - 77%																																																																																																														
			27.510	438	1,75					MPC ED 800 F400	800	20° - 45°	10.900	135	0,54	1500/1000	4/6	0,75 - 4	64% - 80%	34.460	562	2,25	MPC ED 900 F400	900	20° - 42°	16.200	175	0,70	1500/1000	4/6	1,5 - 15	56% - 67%	54.810	850	3,41	MPC ED 1000 F400	1.000	20° - 42°	23.850	176	0,70	1500/1000	4/6	1,5 - 22	64% - 75%	77.810	1.021	4,09	MPC ED 1120 F400	1.120	20° - 42°	32.520	160	0,64	1500/1000	4/6	2,2 - 37	66% - 76%	104.010	1.080	4,33	MPC ED 1250 F400	1.250	20° - 42°	44.030	188	0,75	1500/1000	4/6	3 - 45	65% - 75%	141.010	1.280	5,13																																													
MPC ED 800 F400	800	20° - 45°	10.900	135	0,54	1500/1000	4/6	0,75 - 4	64% - 80%																																																																																																														
			34.460	562	2,25					MPC ED 900 F400	900	20° - 42°	16.200	175	0,70	1500/1000	4/6	1,5 - 15	56% - 67%	54.810	850	3,41	MPC ED 1000 F400	1.000	20° - 42°	23.850	176	0,70	1500/1000	4/6	1,5 - 22	64% - 75%	77.810	1.021	4,09	MPC ED 1120 F400	1.120	20° - 42°	32.520	160	0,64	1500/1000	4/6	2,2 - 37	66% - 76%	104.010	1.080	4,33	MPC ED 1250 F400	1.250	20° - 42°	44.030	188	0,75	1500/1000	4/6	3 - 45	65% - 75%	141.010	1.280	5,13																																																										
MPC ED 900 F400	900	20° - 42°	16.200	175	0,70	1500/1000	4/6	1,5 - 15	56% - 67%																																																																																																														
			54.810	850	3,41					MPC ED 1000 F400	1.000	20° - 42°	23.850	176	0,70	1500/1000	4/6	1,5 - 22	64% - 75%	77.810	1.021	4,09	MPC ED 1120 F400	1.120	20° - 42°	32.520	160	0,64	1500/1000	4/6	2,2 - 37	66% - 76%	104.010	1.080	4,33	MPC ED 1250 F400	1.250	20° - 42°	44.030	188	0,75	1500/1000	4/6	3 - 45	65% - 75%	141.010	1.280	5,13																																																																							
MPC ED 1000 F400	1.000	20° - 42°	23.850	176	0,70	1500/1000	4/6	1,5 - 22	64% - 75%																																																																																																														
			77.810	1.021	4,09					MPC ED 1120 F400	1.120	20° - 42°	32.520	160	0,64	1500/1000	4/6	2,2 - 37	66% - 76%	104.010	1.080	4,33	MPC ED 1250 F400	1.250	20° - 42°	44.030	188	0,75	1500/1000	4/6	3 - 45	65% - 75%	141.010	1.280	5,13																																																																																				
MPC ED 1120 F400	1.120	20° - 42°	32.520	160	0,64	1500/1000	4/6	2,2 - 37	66% - 76%																																																																																																														
			104.010	1.080	4,33					MPC ED 1250 F400	1.250	20° - 42°	44.030	188	0,75	1500/1000	4/6	3 - 45	65% - 75%	141.010	1.280	5,13																																																																																																	
MPC ED 1250 F400	1.250	20° - 42°	44.030	188	0,75	1500/1000	4/6	3 - 45	65% - 75%																																																																																																														
			141.010	1.280	5,13																																																																																																																		

*data represent the range of values for each diameter.

**available from 2020



INDUSTRIAL VENTILATION

MPC-ED F400 and MPC-ED SC F400 RANGE

TECHNICAL DATA*

PRODUCTS	DIAM. Ø	BLADE ANGLE MIN/MAX	FLOW RATE (M ³ /H) MIN/MAX FLOW @ 0 Pa	STATIC RESSURE RANGE (Pa) MIN/MAX	STATIC PRESSURE RANGE (Pa) WATER INCHS MIN/MAX	SPEED (RPM) MIN/MAX	N° OF POLES MIN/MAX	POWER RANGE (kW) MIN/MAX	TOTAL EFFICIENCY % MIN/MAX																																																																																																														
MPC ED 450 F400**	450	20° - 45°	2.243	55	0,22	3000/1500 1500/750	2/4 4/8	0,25 - 2,2	44% - 54%																																																																																																														
			12.400	938	3,76					MPC ED 500 F400**	500	20° - 42,5°	3.430	68	0,27	3000/1500 1500/750	2/4 4/8	0,19 - 3,1	50,5% - 57%	16.200	1.065	4,27	MPC ED 560 F400**	560	20° - 45°	3.530	64	0,25	3000/1500 1.500/750	2/4 4/6 4/8	0,12 - 6	54% - 80%	24.800	1.200	4,81	MPC ED 630 F400	630	20° - 45°	4.930	52	0,20	1.500/1.000 1500/750	4/6 4/8	0,12 - 2,2	65% - 81%	20.340	386	1,54	MPC ED 710 F400	710	20° - 45°	6.750	64	0,25	1500/1000 1500/750	4/6 4/8	0,12 - 4	65,5% - 77%	27.510	440	1,76	MPC ED 800 F400	800	20° - 40°	8.050	86	0,34	1500/1000 1500/750	4/6 4/8	0,37 - 4	64,5% - 80%	34.460	560	2,24	MPC ED 900 F400	900	20° - 42°	12.370	98	0,39	1500/1000 1500/750	4/6 4/8	0,55 - 14	56,5% - 66%	54.810	850	3,41	MPC ED 1000 F400	1.000	20° - 42°	18.490	122	0,48	1500/1000 1500/750	4/6 4/8	1,1 - 20	64% - 74%	77.810	1.017	4,08	MPC ED 1120 F400	1.120	20° - 42°	25.100	100	0,40	1500/1000 1500/750	4/6 4/8	1,5 - 35	66,5% - 76%	104.010	1.080	4,33	MPC ED 1250 F400	1.250	20° - 42°	33.900	113	0,45
MPC ED 500 F400**	500	20° - 42,5°	3.430	68	0,27	3000/1500 1500/750	2/4 4/8	0,19 - 3,1	50,5% - 57%																																																																																																														
			16.200	1.065	4,27					MPC ED 560 F400**	560	20° - 45°	3.530	64	0,25	3000/1500 1.500/750	2/4 4/6 4/8	0,12 - 6	54% - 80%	24.800	1.200	4,81	MPC ED 630 F400	630	20° - 45°	4.930	52	0,20	1.500/1.000 1500/750	4/6 4/8	0,12 - 2,2	65% - 81%	20.340	386	1,54	MPC ED 710 F400	710	20° - 45°	6.750	64	0,25	1500/1000 1500/750	4/6 4/8	0,12 - 4	65,5% - 77%	27.510	440	1,76	MPC ED 800 F400	800	20° - 40°	8.050	86	0,34	1500/1000 1500/750	4/6 4/8	0,37 - 4	64,5% - 80%	34.460	560	2,24	MPC ED 900 F400	900	20° - 42°	12.370	98	0,39	1500/1000 1500/750	4/6 4/8	0,55 - 14	56,5% - 66%	54.810	850	3,41	MPC ED 1000 F400	1.000	20° - 42°	18.490	122	0,48	1500/1000 1500/750	4/6 4/8	1,1 - 20	64% - 74%	77.810	1.017	4,08	MPC ED 1120 F400	1.120	20° - 42°	25.100	100	0,40	1500/1000 1500/750	4/6 4/8	1,5 - 35	66,5% - 76%	104.010	1.080	4,33	MPC ED 1250 F400	1.250	20° - 42°	33.900	113	0,45	1500/750	4/8	3 - 35	65% - 74%	141.010	1.282	5,14						
MPC ED 560 F400**	560	20° - 45°	3.530	64	0,25	3000/1500 1.500/750	2/4 4/6 4/8	0,12 - 6	54% - 80%																																																																																																														
			24.800	1.200	4,81					MPC ED 630 F400	630	20° - 45°	4.930	52	0,20	1.500/1.000 1500/750	4/6 4/8	0,12 - 2,2	65% - 81%	20.340	386	1,54	MPC ED 710 F400	710	20° - 45°	6.750	64	0,25	1500/1000 1500/750	4/6 4/8	0,12 - 4	65,5% - 77%	27.510	440	1,76	MPC ED 800 F400	800	20° - 40°	8.050	86	0,34	1500/1000 1500/750	4/6 4/8	0,37 - 4	64,5% - 80%	34.460	560	2,24	MPC ED 900 F400	900	20° - 42°	12.370	98	0,39	1500/1000 1500/750	4/6 4/8	0,55 - 14	56,5% - 66%	54.810	850	3,41	MPC ED 1000 F400	1.000	20° - 42°	18.490	122	0,48	1500/1000 1500/750	4/6 4/8	1,1 - 20	64% - 74%	77.810	1.017	4,08	MPC ED 1120 F400	1.120	20° - 42°	25.100	100	0,40	1500/1000 1500/750	4/6 4/8	1,5 - 35	66,5% - 76%	104.010	1.080	4,33	MPC ED 1250 F400	1.250	20° - 42°	33.900	113	0,45	1500/750	4/8	3 - 35	65% - 74%	141.010	1.282	5,14																			
MPC ED 630 F400	630	20° - 45°	4.930	52	0,20	1.500/1.000 1500/750	4/6 4/8	0,12 - 2,2	65% - 81%																																																																																																														
			20.340	386	1,54					MPC ED 710 F400	710	20° - 45°	6.750	64	0,25	1500/1000 1500/750	4/6 4/8	0,12 - 4	65,5% - 77%	27.510	440	1,76	MPC ED 800 F400	800	20° - 40°	8.050	86	0,34	1500/1000 1500/750	4/6 4/8	0,37 - 4	64,5% - 80%	34.460	560	2,24	MPC ED 900 F400	900	20° - 42°	12.370	98	0,39	1500/1000 1500/750	4/6 4/8	0,55 - 14	56,5% - 66%	54.810	850	3,41	MPC ED 1000 F400	1.000	20° - 42°	18.490	122	0,48	1500/1000 1500/750	4/6 4/8	1,1 - 20	64% - 74%	77.810	1.017	4,08	MPC ED 1120 F400	1.120	20° - 42°	25.100	100	0,40	1500/1000 1500/750	4/6 4/8	1,5 - 35	66,5% - 76%	104.010	1.080	4,33	MPC ED 1250 F400	1.250	20° - 42°	33.900	113	0,45	1500/750	4/8	3 - 35	65% - 74%	141.010	1.282	5,14																																
MPC ED 710 F400	710	20° - 45°	6.750	64	0,25	1500/1000 1500/750	4/6 4/8	0,12 - 4	65,5% - 77%																																																																																																														
			27.510	440	1,76					MPC ED 800 F400	800	20° - 40°	8.050	86	0,34	1500/1000 1500/750	4/6 4/8	0,37 - 4	64,5% - 80%	34.460	560	2,24	MPC ED 900 F400	900	20° - 42°	12.370	98	0,39	1500/1000 1500/750	4/6 4/8	0,55 - 14	56,5% - 66%	54.810	850	3,41	MPC ED 1000 F400	1.000	20° - 42°	18.490	122	0,48	1500/1000 1500/750	4/6 4/8	1,1 - 20	64% - 74%	77.810	1.017	4,08	MPC ED 1120 F400	1.120	20° - 42°	25.100	100	0,40	1500/1000 1500/750	4/6 4/8	1,5 - 35	66,5% - 76%	104.010	1.080	4,33	MPC ED 1250 F400	1.250	20° - 42°	33.900	113	0,45	1500/750	4/8	3 - 35	65% - 74%	141.010	1.282	5,14																																													
MPC ED 800 F400	800	20° - 40°	8.050	86	0,34	1500/1000 1500/750	4/6 4/8	0,37 - 4	64,5% - 80%																																																																																																														
			34.460	560	2,24					MPC ED 900 F400	900	20° - 42°	12.370	98	0,39	1500/1000 1500/750	4/6 4/8	0,55 - 14	56,5% - 66%	54.810	850	3,41	MPC ED 1000 F400	1.000	20° - 42°	18.490	122	0,48	1500/1000 1500/750	4/6 4/8	1,1 - 20	64% - 74%	77.810	1.017	4,08	MPC ED 1120 F400	1.120	20° - 42°	25.100	100	0,40	1500/1000 1500/750	4/6 4/8	1,5 - 35	66,5% - 76%	104.010	1.080	4,33	MPC ED 1250 F400	1.250	20° - 42°	33.900	113	0,45	1500/750	4/8	3 - 35	65% - 74%	141.010	1.282	5,14																																																										
MPC ED 900 F400	900	20° - 42°	12.370	98	0,39	1500/1000 1500/750	4/6 4/8	0,55 - 14	56,5% - 66%																																																																																																														
			54.810	850	3,41					MPC ED 1000 F400	1.000	20° - 42°	18.490	122	0,48	1500/1000 1500/750	4/6 4/8	1,1 - 20	64% - 74%	77.810	1.017	4,08	MPC ED 1120 F400	1.120	20° - 42°	25.100	100	0,40	1500/1000 1500/750	4/6 4/8	1,5 - 35	66,5% - 76%	104.010	1.080	4,33	MPC ED 1250 F400	1.250	20° - 42°	33.900	113	0,45	1500/750	4/8	3 - 35	65% - 74%	141.010	1.282	5,14																																																																							
MPC ED 1000 F400	1.000	20° - 42°	18.490	122	0,48	1500/1000 1500/750	4/6 4/8	1,1 - 20	64% - 74%																																																																																																														
			77.810	1.017	4,08					MPC ED 1120 F400	1.120	20° - 42°	25.100	100	0,40	1500/1000 1500/750	4/6 4/8	1,5 - 35	66,5% - 76%	104.010	1.080	4,33	MPC ED 1250 F400	1.250	20° - 42°	33.900	113	0,45	1500/750	4/8	3 - 35	65% - 74%	141.010	1.282	5,14																																																																																				
MPC ED 1120 F400	1.120	20° - 42°	25.100	100	0,40	1500/1000 1500/750	4/6 4/8	1,5 - 35	66,5% - 76%																																																																																																														
			104.010	1.080	4,33					MPC ED 1250 F400	1.250	20° - 42°	33.900	113	0,45	1500/750	4/8	3 - 35	65% - 74%	141.010	1.282	5,14																																																																																																	
MPC ED 1250 F400	1.250	20° - 42°	33.900	113	0,45	1500/750	4/8	3 - 35	65% - 74%																																																																																																														
			141.010	1.282	5,14																																																																																																																		

*data represent the range of values for each diameter.

**available from 2020



TECHNICAL DATA*

PRODUCTS	DIAM. Ø	BLADE ANGLE MIN/MAX	FLOW RATE (M ³ /H) MIN/MAX FLOW @ 0 Pa	STATIC RESSURE RANGE (Pa) MIN/MAX	STATIC PRESSURE RANGE (Pa) WATER INCHS MIN/MAX	SPEED (RPM) MIN/MAX	N° OF POLES MIN/MAX	POWER RANGE (kW) MIN/MAX	TOTAL EFFICIENCY % MIN/MAX																																																																																																														
MPC ED SC 450 F400	450	20° - 45°	2.756	54	0,21	1500/1000	4/6	0,55 - 0,75	38% - 51%																																																																																																														
			6.143	149	0,59					MPC ED SC 500 F400	500	20° - 45°	3.971	61	0,24	1500/1000	4/6	0,55 - 0,75	44% - 56%	9.160	172	0,69	MPC ED SC 560 F400	560	20° - 45°	4.780	113	0,45	1500/1000	4/6	0,55 - 1,5	64% - 80%	14.630	325	1,30	MPC ED SC 630 F400	630	20° - 45°	6.635	96	0,38	1500/1000	4/6	0,75 - 7,5	65% - 81%	20.340	379	1,52	MPC ED SC 710 F400	710	20° - 45°	9.038	114	0,45	1500/1000	4/6	0,55 - 3	66% - 77%	27.510	442	1,77	MPC ED SC 800 F400	800	20° - 45°	10.900	134	0,53	1500/1000	4/6	0,75 - 4	64% - 80%	34.460	562	2,25	MPC ED SC 900 F400	900	20° - 42°	16.200	154	0,61	1500/1000	4/6	1,5 - 15	57% - 64%	54.810	846	3,39	MPC ED SC 1000 F400	1.000	20° - 42°	23.850	176	0,70	1500/1000	4/6	1,5 - 22	64% - 73%	77.810	1.013	4,06	MPC ED SC 1120 F400	1.120	20° - 42°	32.520	159	0,63	1500/1000	4/6	2,2 - 37	66% - 76%	104.010	1.074	4,31	MPC ED SC 1250 F400	1.250	20° - 42°	44.030	188	0,75
MPC ED SC 500 F400	500	20° - 45°	3.971	61	0,24	1500/1000	4/6	0,55 - 0,75	44% - 56%																																																																																																														
			9.160	172	0,69					MPC ED SC 560 F400	560	20° - 45°	4.780	113	0,45	1500/1000	4/6	0,55 - 1,5	64% - 80%	14.630	325	1,30	MPC ED SC 630 F400	630	20° - 45°	6.635	96	0,38	1500/1000	4/6	0,75 - 7,5	65% - 81%	20.340	379	1,52	MPC ED SC 710 F400	710	20° - 45°	9.038	114	0,45	1500/1000	4/6	0,55 - 3	66% - 77%	27.510	442	1,77	MPC ED SC 800 F400	800	20° - 45°	10.900	134	0,53	1500/1000	4/6	0,75 - 4	64% - 80%	34.460	562	2,25	MPC ED SC 900 F400	900	20° - 42°	16.200	154	0,61	1500/1000	4/6	1,5 - 15	57% - 64%	54.810	846	3,39	MPC ED SC 1000 F400	1.000	20° - 42°	23.850	176	0,70	1500/1000	4/6	1,5 - 22	64% - 73%	77.810	1.013	4,06	MPC ED SC 1120 F400	1.120	20° - 42°	32.520	159	0,63	1500/1000	4/6	2,2 - 37	66% - 76%	104.010	1.074	4,31	MPC ED SC 1250 F400	1.250	20° - 42°	44.030	188	0,75	1500/1000	4/6	3 - 45	65% - 74%	141.010	1.287	5,16						
MPC ED SC 560 F400	560	20° - 45°	4.780	113	0,45	1500/1000	4/6	0,55 - 1,5	64% - 80%																																																																																																														
			14.630	325	1,30					MPC ED SC 630 F400	630	20° - 45°	6.635	96	0,38	1500/1000	4/6	0,75 - 7,5	65% - 81%	20.340	379	1,52	MPC ED SC 710 F400	710	20° - 45°	9.038	114	0,45	1500/1000	4/6	0,55 - 3	66% - 77%	27.510	442	1,77	MPC ED SC 800 F400	800	20° - 45°	10.900	134	0,53	1500/1000	4/6	0,75 - 4	64% - 80%	34.460	562	2,25	MPC ED SC 900 F400	900	20° - 42°	16.200	154	0,61	1500/1000	4/6	1,5 - 15	57% - 64%	54.810	846	3,39	MPC ED SC 1000 F400	1.000	20° - 42°	23.850	176	0,70	1500/1000	4/6	1,5 - 22	64% - 73%	77.810	1.013	4,06	MPC ED SC 1120 F400	1.120	20° - 42°	32.520	159	0,63	1500/1000	4/6	2,2 - 37	66% - 76%	104.010	1.074	4,31	MPC ED SC 1250 F400	1.250	20° - 42°	44.030	188	0,75	1500/1000	4/6	3 - 45	65% - 74%	141.010	1.287	5,16																			
MPC ED SC 630 F400	630	20° - 45°	6.635	96	0,38	1500/1000	4/6	0,75 - 7,5	65% - 81%																																																																																																														
			20.340	379	1,52					MPC ED SC 710 F400	710	20° - 45°	9.038	114	0,45	1500/1000	4/6	0,55 - 3	66% - 77%	27.510	442	1,77	MPC ED SC 800 F400	800	20° - 45°	10.900	134	0,53	1500/1000	4/6	0,75 - 4	64% - 80%	34.460	562	2,25	MPC ED SC 900 F400	900	20° - 42°	16.200	154	0,61	1500/1000	4/6	1,5 - 15	57% - 64%	54.810	846	3,39	MPC ED SC 1000 F400	1.000	20° - 42°	23.850	176	0,70	1500/1000	4/6	1,5 - 22	64% - 73%	77.810	1.013	4,06	MPC ED SC 1120 F400	1.120	20° - 42°	32.520	159	0,63	1500/1000	4/6	2,2 - 37	66% - 76%	104.010	1.074	4,31	MPC ED SC 1250 F400	1.250	20° - 42°	44.030	188	0,75	1500/1000	4/6	3 - 45	65% - 74%	141.010	1.287	5,16																																
MPC ED SC 710 F400	710	20° - 45°	9.038	114	0,45	1500/1000	4/6	0,55 - 3	66% - 77%																																																																																																														
			27.510	442	1,77					MPC ED SC 800 F400	800	20° - 45°	10.900	134	0,53	1500/1000	4/6	0,75 - 4	64% - 80%	34.460	562	2,25	MPC ED SC 900 F400	900	20° - 42°	16.200	154	0,61	1500/1000	4/6	1,5 - 15	57% - 64%	54.810	846	3,39	MPC ED SC 1000 F400	1.000	20° - 42°	23.850	176	0,70	1500/1000	4/6	1,5 - 22	64% - 73%	77.810	1.013	4,06	MPC ED SC 1120 F400	1.120	20° - 42°	32.520	159	0,63	1500/1000	4/6	2,2 - 37	66% - 76%	104.010	1.074	4,31	MPC ED SC 1250 F400	1.250	20° - 42°	44.030	188	0,75	1500/1000	4/6	3 - 45	65% - 74%	141.010	1.287	5,16																																													
MPC ED SC 800 F400	800	20° - 45°	10.900	134	0,53	1500/1000	4/6	0,75 - 4	64% - 80%																																																																																																														
			34.460	562	2,25					MPC ED SC 900 F400	900	20° - 42°	16.200	154	0,61	1500/1000	4/6	1,5 - 15	57% - 64%	54.810	846	3,39	MPC ED SC 1000 F400	1.000	20° - 42°	23.850	176	0,70	1500/1000	4/6	1,5 - 22	64% - 73%	77.810	1.013	4,06	MPC ED SC 1120 F400	1.120	20° - 42°	32.520	159	0,63	1500/1000	4/6	2,2 - 37	66% - 76%	104.010	1.074	4,31	MPC ED SC 1250 F400	1.250	20° - 42°	44.030	188	0,75	1500/1000	4/6	3 - 45	65% - 74%	141.010	1.287	5,16																																																										
MPC ED SC 900 F400	900	20° - 42°	16.200	154	0,61	1500/1000	4/6	1,5 - 15	57% - 64%																																																																																																														
			54.810	846	3,39					MPC ED SC 1000 F400	1.000	20° - 42°	23.850	176	0,70	1500/1000	4/6	1,5 - 22	64% - 73%	77.810	1.013	4,06	MPC ED SC 1120 F400	1.120	20° - 42°	32.520	159	0,63	1500/1000	4/6	2,2 - 37	66% - 76%	104.010	1.074	4,31	MPC ED SC 1250 F400	1.250	20° - 42°	44.030	188	0,75	1500/1000	4/6	3 - 45	65% - 74%	141.010	1.287	5,16																																																																							
MPC ED SC 1000 F400	1.000	20° - 42°	23.850	176	0,70	1500/1000	4/6	1,5 - 22	64% - 73%																																																																																																														
			77.810	1.013	4,06					MPC ED SC 1120 F400	1.120	20° - 42°	32.520	159	0,63	1500/1000	4/6	2,2 - 37	66% - 76%	104.010	1.074	4,31	MPC ED SC 1250 F400	1.250	20° - 42°	44.030	188	0,75	1500/1000	4/6	3 - 45	65% - 74%	141.010	1.287	5,16																																																																																				
MPC ED SC 1120 F400	1.120	20° - 42°	32.520	159	0,63	1500/1000	4/6	2,2 - 37	66% - 76%																																																																																																														
			104.010	1.074	4,31					MPC ED SC 1250 F400	1.250	20° - 42°	44.030	188	0,75	1500/1000	4/6	3 - 45	65% - 74%	141.010	1.287	5,16																																																																																																	
MPC ED SC 1250 F400	1.250	20° - 42°	44.030	188	0,75	1500/1000	4/6	3 - 45	65% - 74%																																																																																																														
			141.010	1.287	5,16																																																																																																																		

*data represent the range of values for each diameter.



INDUSTRIAL VENTILATION

MPC-ED F400 and MPC-ED SC F400 RANGE

TECHNICAL DATA*

PRODUCTS	DIAM. Ø	BLADE ANGLE MIN/MAX	FLOW RATE (M ³ /H) MIN/MAX FLOW @ 0 Pa	STATIC RESSURE RANGE (Pa) MIN/MAX	STATIC PRESSURE RANGE (Pa) WATER INCHS MIN/MAX	SPEED (RPM) MIN/MAX	N° OF POLES MIN/MAX	POWER RANGE (kW) MIN/MAX	TOTAL EFFICIENCY % MIN/MAX																																																																																																														
MPC ED SC 450 F400	450	20° - 45°	2.243	55	0,22	1500/750	4/8	0,19 - 0,75	44,5% - 48,5%																																																																																																														
			7.300	208	0,83					MPC ED SC 500 F400	500	20° - 42,5°	3.430	68	0,27	1500/750	4/8	0,19 - 0,75	51% - 54%	9.500	235	0,94	MPC ED SC 560 F400	560	20° - 45°	3.530	64	0,25	1500/750	4/8	0,12 - 1,5	64% - 80%	14.630	326	1,30	MPC ED SC 630 F400	630	20° - 45°	4.930	52	0,20	1500/750	4/8	0,12 - 2,2	65% - 81%	20.340	386	1,54	MPC ED SC 710 F400	710	20° - 45°	6.750	64	0,25	1500/750	4/8	0,12 - 4	66% - 77%	27.510	440	1,76	MPC ED SC 800 F400	800	20° - 40°	8.050	86	0,34	1500/750	4/8	0,37 - 4	65% - 80%	34.460	560	2,24	MPC ED SC 900 F400	900	20° - 42°	12.370	98	0,39	1500/750	4/8	0,55 - 14	56% - 65%	54.810	850	3,41	MPC ED SC 1000 F400	1.000	20° - 42°	18.490	122	0,48	1500/750	4/8	1,1 - 20	63% - 73%	77.810	1.017	4,08	MPC ED SC 1120 F400	1.120	20° - 42°	25.100	100	0,40	1500/750	4/8	1,5 - 35	66% - 77%	104.010	1.080	4,33	MPC ED SC 1250 F400	1.250	20° - 42°	33.900	113	0,45
MPC ED SC 500 F400	500	20° - 42,5°	3.430	68	0,27	1500/750	4/8	0,19 - 0,75	51% - 54%																																																																																																														
			9.500	235	0,94					MPC ED SC 560 F400	560	20° - 45°	3.530	64	0,25	1500/750	4/8	0,12 - 1,5	64% - 80%	14.630	326	1,30	MPC ED SC 630 F400	630	20° - 45°	4.930	52	0,20	1500/750	4/8	0,12 - 2,2	65% - 81%	20.340	386	1,54	MPC ED SC 710 F400	710	20° - 45°	6.750	64	0,25	1500/750	4/8	0,12 - 4	66% - 77%	27.510	440	1,76	MPC ED SC 800 F400	800	20° - 40°	8.050	86	0,34	1500/750	4/8	0,37 - 4	65% - 80%	34.460	560	2,24	MPC ED SC 900 F400	900	20° - 42°	12.370	98	0,39	1500/750	4/8	0,55 - 14	56% - 65%	54.810	850	3,41	MPC ED SC 1000 F400	1.000	20° - 42°	18.490	122	0,48	1500/750	4/8	1,1 - 20	63% - 73%	77.810	1.017	4,08	MPC ED SC 1120 F400	1.120	20° - 42°	25.100	100	0,40	1500/750	4/8	1,5 - 35	66% - 77%	104.010	1.080	4,33	MPC ED SC 1250 F400	1.250	20° - 42°	33.900	113	0,45	1500/750	4/8	3 - 35	65% - 74%	141.010	1.282	5,14						
MPC ED SC 560 F400	560	20° - 45°	3.530	64	0,25	1500/750	4/8	0,12 - 1,5	64% - 80%																																																																																																														
			14.630	326	1,30					MPC ED SC 630 F400	630	20° - 45°	4.930	52	0,20	1500/750	4/8	0,12 - 2,2	65% - 81%	20.340	386	1,54	MPC ED SC 710 F400	710	20° - 45°	6.750	64	0,25	1500/750	4/8	0,12 - 4	66% - 77%	27.510	440	1,76	MPC ED SC 800 F400	800	20° - 40°	8.050	86	0,34	1500/750	4/8	0,37 - 4	65% - 80%	34.460	560	2,24	MPC ED SC 900 F400	900	20° - 42°	12.370	98	0,39	1500/750	4/8	0,55 - 14	56% - 65%	54.810	850	3,41	MPC ED SC 1000 F400	1.000	20° - 42°	18.490	122	0,48	1500/750	4/8	1,1 - 20	63% - 73%	77.810	1.017	4,08	MPC ED SC 1120 F400	1.120	20° - 42°	25.100	100	0,40	1500/750	4/8	1,5 - 35	66% - 77%	104.010	1.080	4,33	MPC ED SC 1250 F400	1.250	20° - 42°	33.900	113	0,45	1500/750	4/8	3 - 35	65% - 74%	141.010	1.282	5,14																			
MPC ED SC 630 F400	630	20° - 45°	4.930	52	0,20	1500/750	4/8	0,12 - 2,2	65% - 81%																																																																																																														
			20.340	386	1,54					MPC ED SC 710 F400	710	20° - 45°	6.750	64	0,25	1500/750	4/8	0,12 - 4	66% - 77%	27.510	440	1,76	MPC ED SC 800 F400	800	20° - 40°	8.050	86	0,34	1500/750	4/8	0,37 - 4	65% - 80%	34.460	560	2,24	MPC ED SC 900 F400	900	20° - 42°	12.370	98	0,39	1500/750	4/8	0,55 - 14	56% - 65%	54.810	850	3,41	MPC ED SC 1000 F400	1.000	20° - 42°	18.490	122	0,48	1500/750	4/8	1,1 - 20	63% - 73%	77.810	1.017	4,08	MPC ED SC 1120 F400	1.120	20° - 42°	25.100	100	0,40	1500/750	4/8	1,5 - 35	66% - 77%	104.010	1.080	4,33	MPC ED SC 1250 F400	1.250	20° - 42°	33.900	113	0,45	1500/750	4/8	3 - 35	65% - 74%	141.010	1.282	5,14																																
MPC ED SC 710 F400	710	20° - 45°	6.750	64	0,25	1500/750	4/8	0,12 - 4	66% - 77%																																																																																																														
			27.510	440	1,76					MPC ED SC 800 F400	800	20° - 40°	8.050	86	0,34	1500/750	4/8	0,37 - 4	65% - 80%	34.460	560	2,24	MPC ED SC 900 F400	900	20° - 42°	12.370	98	0,39	1500/750	4/8	0,55 - 14	56% - 65%	54.810	850	3,41	MPC ED SC 1000 F400	1.000	20° - 42°	18.490	122	0,48	1500/750	4/8	1,1 - 20	63% - 73%	77.810	1.017	4,08	MPC ED SC 1120 F400	1.120	20° - 42°	25.100	100	0,40	1500/750	4/8	1,5 - 35	66% - 77%	104.010	1.080	4,33	MPC ED SC 1250 F400	1.250	20° - 42°	33.900	113	0,45	1500/750	4/8	3 - 35	65% - 74%	141.010	1.282	5,14																																													
MPC ED SC 800 F400	800	20° - 40°	8.050	86	0,34	1500/750	4/8	0,37 - 4	65% - 80%																																																																																																														
			34.460	560	2,24					MPC ED SC 900 F400	900	20° - 42°	12.370	98	0,39	1500/750	4/8	0,55 - 14	56% - 65%	54.810	850	3,41	MPC ED SC 1000 F400	1.000	20° - 42°	18.490	122	0,48	1500/750	4/8	1,1 - 20	63% - 73%	77.810	1.017	4,08	MPC ED SC 1120 F400	1.120	20° - 42°	25.100	100	0,40	1500/750	4/8	1,5 - 35	66% - 77%	104.010	1.080	4,33	MPC ED SC 1250 F400	1.250	20° - 42°	33.900	113	0,45	1500/750	4/8	3 - 35	65% - 74%	141.010	1.282	5,14																																																										
MPC ED SC 900 F400	900	20° - 42°	12.370	98	0,39	1500/750	4/8	0,55 - 14	56% - 65%																																																																																																														
			54.810	850	3,41					MPC ED SC 1000 F400	1.000	20° - 42°	18.490	122	0,48	1500/750	4/8	1,1 - 20	63% - 73%	77.810	1.017	4,08	MPC ED SC 1120 F400	1.120	20° - 42°	25.100	100	0,40	1500/750	4/8	1,5 - 35	66% - 77%	104.010	1.080	4,33	MPC ED SC 1250 F400	1.250	20° - 42°	33.900	113	0,45	1500/750	4/8	3 - 35	65% - 74%	141.010	1.282	5,14																																																																							
MPC ED SC 1000 F400	1.000	20° - 42°	18.490	122	0,48	1500/750	4/8	1,1 - 20	63% - 73%																																																																																																														
			77.810	1.017	4,08					MPC ED SC 1120 F400	1.120	20° - 42°	25.100	100	0,40	1500/750	4/8	1,5 - 35	66% - 77%	104.010	1.080	4,33	MPC ED SC 1250 F400	1.250	20° - 42°	33.900	113	0,45	1500/750	4/8	3 - 35	65% - 74%	141.010	1.282	5,14																																																																																				
MPC ED SC 1120 F400	1.120	20° - 42°	25.100	100	0,40	1500/750	4/8	1,5 - 35	66% - 77%																																																																																																														
			104.010	1.080	4,33					MPC ED SC 1250 F400	1.250	20° - 42°	33.900	113	0,45	1500/750	4/8	3 - 35	65% - 74%	141.010	1.282	5,14																																																																																																	
MPC ED SC 1250 F400	1.250	20° - 42°	33.900	113	0,45	1500/750	4/8	3 - 35	65% - 74%																																																																																																														
			141.010	1.282	5,14																																																																																																																		

*data represent the range of values for each diameter.



DIMENSIONS

MPC ED F400

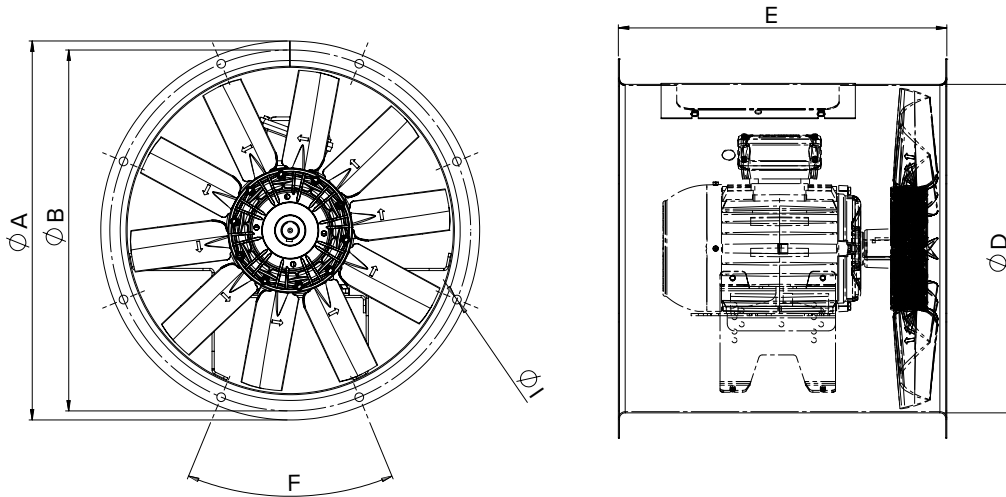

PRODUCTS	ØA	ØB	D	E	ØI	F
MPC ED 450 F400	525	500	452	455	12	8x45
MPC ED 500 F400	600	560	504	440	12	12x30
MPC ED 500 F400 (2 poles)	600	560	504	540	12	12x30
MPC ED 560 F400	646	620	559	560	12	12x30
MPC ED 630 F400	725	690	633	550	12	12x30
MPC ED 710 F400	802	770	715	600	12	6x22,5
MPC ED 800 F400	892	860	801	600	12	6x22,5
MPC ED 900 F400	1000	970	903,5	820	12	6x22,5
MPC ED 1000 F400	1115	1070	1013	820	12	6x22,5
MPC ED 1120 F400	1234	1190	1132	1000	12	6x22,5
MPC ED 1250 F400	1365	1320	1263	1000	15	20x18

Dimensions (mm)



INDUSTRIAL VENTILATION

MPC-ED F400 and MPC-ED SC F400 RANGE

DIMENSIONS

MPC ED SC F400

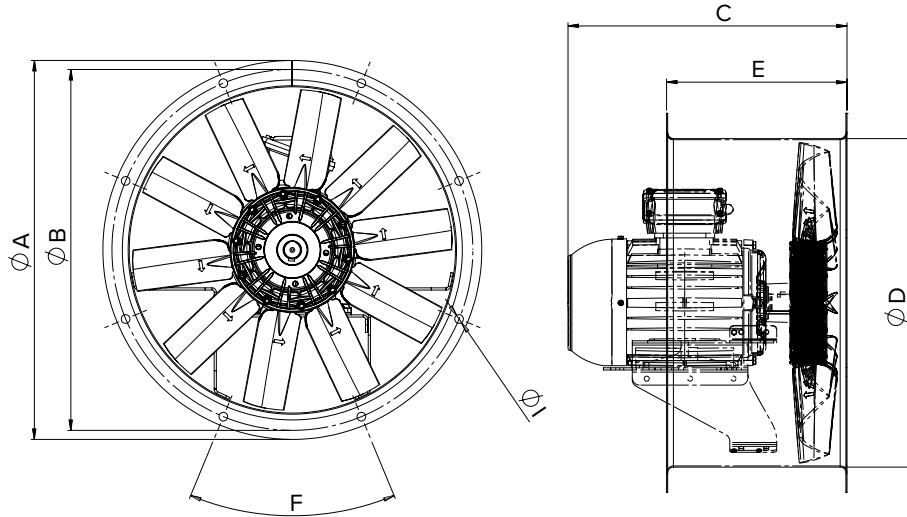

Models	ØA	ØB	C														D	E	ØI	F	
			63°	71°	80°	90S°	90L°	100L°	112M°	132S°	132M°	160M°	160L°	180M°	180L°	200°					225°
MPC ED SC 450 F400	525	500	338	348	357	372	397	428	-	-	-	-	-	-	-	-	-	452	250	12	8x45
MPC ED SC 500 F400	600	560	-	348	360	372	397	428	-	-	-	-	-	-	-	-	-	504	250	12	12x30
MPC ED SC 560 F400	646	620	-	348	362	372	397	433	-	-	-	-	-	-	-	-	-	559	250	12	12x30
MPC ED SC 630 F400	725	690	-	-	359	393	398	450	471	-	-	-	-	-	-	-	-	633	250	12	12x30
MPC ED SC 710 F400	802	770	-	-	362	396	421	452	473	-	-	-	-	-	-	-	-	715	350	12	6x22,5
MPC ED SC 800 F400	892	860	-	-	-	445	445	476	477	533	571	-	-	-	-	-	-	801	350	12	6x22,5
MPC ED SC 900 F400	1000	970	-	-	-	-	-	655	655	655	655	718	762	756	794	-	-	903,5	425	12	6x22,5
MPC ED SC 1000 F400	1115	1070	-	-	-	-	-	-	655	655	718	762	756	794	-	-	1013	425	12	6x22,5	
MPC ED SC 1120 F400	1234	1190	-	-	-	-	-	-	765	765	765	772	766	804	869	954	1132	500	12	6x22,5	
MPC ED SC 1250 F400	1365	1320	-	-	-	-	-	-	765	765	765	772	766	804	869	954	1263	500	15	20x18	

Dimensions (mm)

* motor size



ACCESSORIES

MODELS	DESCRIPTION
	MSC2-F400 -wire guards, motor side an fan side
	MSC3-F400 Wire guards, motor side, for VORT MPC ED SC F400
	MFT-F400 - Supports
	MFC-F400 - Connection flanges
	EBY-ED-F400 - Circular flexible connections, resistant up to 400 °C
	SCM-F400 - Backdraught shutter for horizontal and vertical installation
	FJ-F400 - Flexible joints for riveting between fan and duct to avoid the transmission of vibrations
	FLCC-F400 - Circular-circular coupling flange through anti-vibration canvas
	SLE-F400 - Inlet / outlet circular silencers
	SLE-P-F400 - Inlet / outlet circular silencers with inner pod
	IREM/IRET INVERTER - Frequency inverters
	SWT-F400 - Safety switches for local disconnection of F400/120 ventilation equipments according to EN 12101-3. Suited for direct control of motor in AC 3 operation category.
	SWT - Safety start-stop switch according to UNI EN 60947-1 and UNI EN 60947-3. IP65 and always equipped with an auxiliary contact. Useful for cutting the current before handling the fan.
	XS-F400 - Anti-vibration blocks with springs
	NRD-F400 - Anti-vibration rubber block
	EMC FTR - EMC Filter for IREM/IRET INVERTER Frequency speed controllers



SOFTWARE

Fan Selection

VORTICE Fan selection allows customers the ability to select the right fan starting from the duty point (flow rate and static pressure) in case MPC HP and MPC ED. The fan selection process has been designed for an easy use.

Fans can be selected from categories ranging from “MPC HP” to “MPC ED” to "VORT JET". These categories can be further broken down into diameter, prices and efficiency.

Once the product category/type are selected and the operating conditions are entered, the program searches across all available products to meet the selection criteria. Once a fan is selected, the user has the option to view its technical data, its performance curve (if any) and its identification code, print the results or save the selection for future uses. In addition, he can create a drawing for the selected fan. The software allows the user to specify a very detailed list of input data and parameters. It enables also a very detailed and specific selection, giving the user the possibility to specify a wide range of information for the fans to be selected. In a very quick and straightforward way, the software propose a set of fans that match the input criteria.

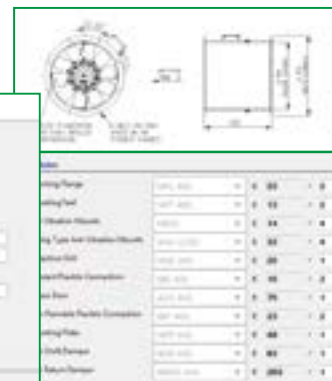
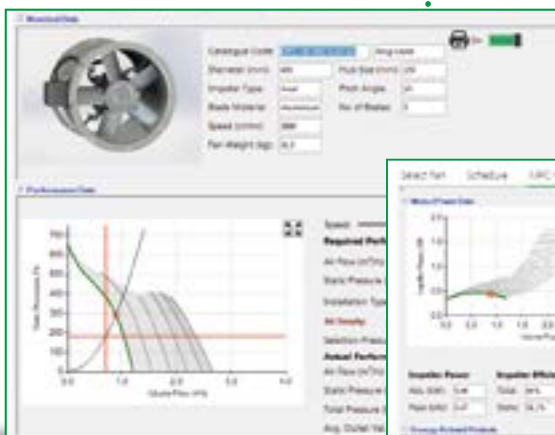
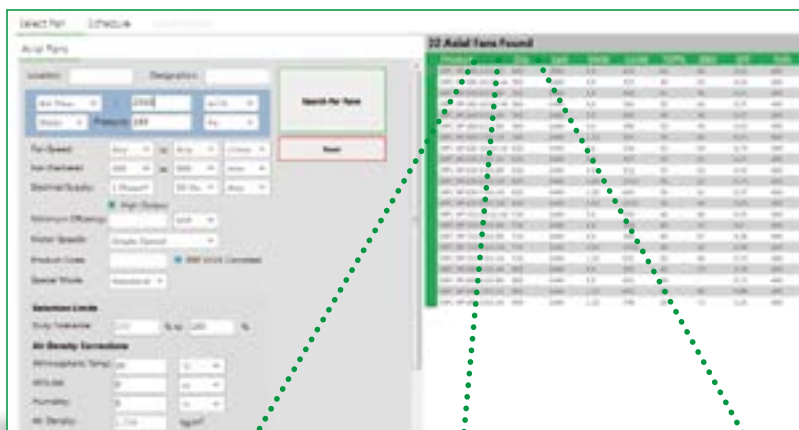





VORTICENT C E RANGE

Centrifugal fans

Industrial centrifugal fans, available in single and three-phase versions for ventilation systems characterized by high pressure drops in commercial and industrial premises, such as public toilets, shops, laboratories, laundries, restaurants, theatres and ballrooms.

Key features

- Robust and weatherproof construction.
- Possibility of adapting the direction of the delivery to system requirements for easier installation.
- Easy maintenance, thanks to easy removal of the impellers from the scrolls

Versions

21 models, in single and three-phase versions, with 2 and 4 poles..

Technical features

- Painted sheet steel scrolls with many holes to allow for motor orientation into 8 alternative positions with respect to the delivery spigot, complete with coupling flange to the downstream piping.
- Ventilation ports fashioned in one piece with the respective scrolls, calibrated to optimize inlet airflow.
- Class F thermally protected asynchronous motors, with shafts turning on ball bearings with double sealing screen, characterized by high (IP55) degree of protection against dust and water, speed adjustable by Vortice controllers.
- Starting capacitors of the single-phase models comply with the EN 60252-1 standard and are third-party certified.
- Centrifugal impellers with galvanised sheet steel forward curved blades, dynamically balanced (UNI ISO 1940, Class 6.3), fitted on grooved hubs in die cast aluminium.

Note

- The fans of the VORTICENT C-E range comply with Reg. ErP No. 327/2011/UE.
- The fans of the VORTICENT C-E range are specifically designed for applications that envision high pressure drops. They are not suitable for handling flows characterized by significant concentrations of abrasive powders or acid or corrosive substances.

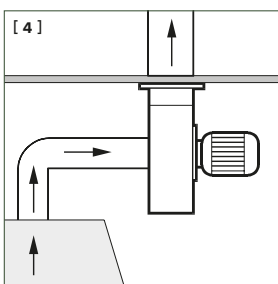
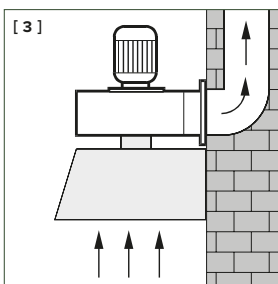
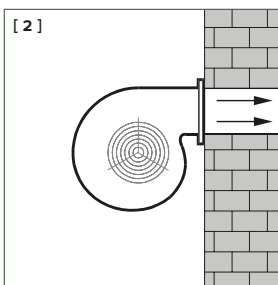

[1] Robust construction.

[2] [3] [4] These fans can be installed where there are high pressure drops. The air must not be dusty, acidic or corrosive.



TECHNICAL DATA

	PRODUCTS	CODE	V~50HZ	W	A	POLES	RPM	MAX AIRFLOW		MAX PRESSURE		Lp dB(A)* 3 m	MAX °C**	KG
								m³/h	l/s	mmH₂O	Pa			
SINGLE-PHASE	C 10/2 M	30302	230	100	0.45	2	2800	300	83.3	25.0	245.0	55.5	50	2.7
	C 15/2 M	30902	230	160	0.70	2	2800	450	125.0	45.0	441.0	59.0	50	5.0
	C 20/2 M E	30321	230	350	1.50	2	2800	810	225.0	51.1	501.0	66.0	50	6.0
	C 25/2 M E	30323	230	390	1.7	2	2800	955	265.0	59.5	584.0	66.5	50	6.8
	C 30/2 M E	30325	230	740	3.20	2	2800	1420	394.4	84.0	824.0	71.0	50	8.4
	C 30/4 M E	30327	230	132	0.582	4	1400	700	194.0	19.8	194.0	55.0	50	9.0
	C 35/4 M E	30330	230	310	1.37	4	1400	1270	353.0	33.1	325.0	61.0	50	11.0
	C 37/4 M E	30332	230	600	2.70	4	1400	2100	583.0	43.0	422.0	70.0	50	20.5
	C 40/4 M E	30334	230	870	3.80	4	1400	2700	750.0	51.0	500.0	73.0	50	21.0
	C 10/2 T	30351	230/400	130	0.50/0.30	2	2800	270	75.0	25.0	245.0	55.5	50	4.6
C 15/2 T	30951	230/400	160	0.60/0.35	2	2800	430	119.4	43.0	422.0	59.0	50	3.3	
THREE-PHASE	C 20/2 T E	30322	400	330	0.54	2	2800	800	222.0	52.7	517.0	66.0	50	5.8
	C 25/2 T E	30324	400	390	0.63	2	2800	970	269.0	58.0	569.0	66.5	50	6.3
	C 30/2 T E	30326	400	720	1.50	2	2800	1350	375.0	85.0	834.0	71.0	50	8.1
	C 30/4 T E	30328	400	110	0.19	4	1400	655	182.0	13.2	176.0	55.0	50	8.1
	C 31/4 T E	30329	400	175	0.28	4	1400	825	229.0	28.7	281.0	61.0	50	9.5
	C 35/4 T E	30331	400	350	0.70	4	1400	1550	430.6	34.0	334.0	61.0	50	9.3
	C 37/4 T E	30333	400	600	1.00	4	1380	2050	269.5	45.1	442.3	70.0	50	20.5
	C 40/4 T E	30335	400	750	1.20	4	1320	2310	641.6	51.7	507.1	73.0	50	21.0
	C 45/4 T E	30336	400	1900	4.35	4	1400	4500	1250	74.0	726.0	70.5	50	23.3
	C 46/4 T E	30337	400	3400	5.50	4	1400	6650	1847	83.0	814.0	76.5	30	61.0

*Sound pressure level measured at 3 m in free field conditions in accordance with standard ISO 3741.

** Maximum continuous operating temperature of the product.



INDUSTRIAL VENTILATION

VORTICENT C E RANGE

ERP DATA DIRECTIVE N° 327/2011/UE

	PRODUCTS	CODE	CAT. MISURA	CAT. EFFICIENZA	ANNO DI INTRODUZIONE SUL MERCATO	VARIATORE	η	N.	Pe kW	q m ³ /h	BEP* p Pa	RPM	Rapp. spec. <1.04
SINGLE-PHASE	C 20/2 M E	30321	B	TOTALE	2015	NO	38.2	49.0	0.196	522	506	2840	SI
	C 25/2 M E	30323	B	TOTALE	2015	NO	38.9	49.0	0.257	697	509	2845	SI
	C 30/2 M E	30325	B	TOTALE	2013	NO	41.6	50.0	0.465	876	584	2892	SI
	C 35/4 M E	30330	B	TOTALE	2015	NO	38.7	50.0	0.191	847	313	1400	SI
	C 37/4 M E	30332	B	TOTALE	2015	NO	39.8	49.0	0.415	1445	412	1462	SI
	C 40/4 M E	30334	B	TOTALE	2015	NO	40.5	49.0	0.474	1535	450	1442	SI
THREE-PHASE	C 20/2 T E	30322	B	TOTALE	2015	NO	40.3	51.0	0.182	522	505	2877	SI
	C 25/2 T E	30324	B	TOTALE	2015	NO	38.1	49.0	0.179	511	481	2915	SI
	C 30/2 T E	30326	B	TOTALE	2013	NO	43.2	51.8	0.434	866	779.5	2914	SI
	C 35/4 T E	30331	B	TOTALE	2013	NO	41.1	51.5	0.230	1021	222	1443	SI
	C 37/4 T E	30333	B	TOTALE	2015	NO	44.3	54.1	0.281	1092	410	1450	SI
	C 40/4 T E	30335	B	TOTALE	2015	NO	43.6	53.2	0.301	1115	424	1440	SI
	C 45/4 T E	30336	B	TOTALE	2013	NO	49.7	56.3	0.913	2399	681.5	1472	SI
	C 46/4 T E	30337	B	TOTALE	2015	NO	45.0	49.0	2.054	4103	811	1432	SI

* Best efficiency point.

ORIENTATION

The position of a radial fan delivery outlet is represented by a direction of rotation symbol (LG - that is, towards the left of anti-clockwise, looking from the side opposite the air intake inlet) and the angle (in degrees) of the delivery outlet to the reference axis (a straight line perpendicular to the base plane, passing through the axis of rotation), measured in the direction of rotation.

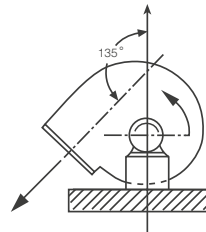

Designation of delivery outlet position for radial fans.

Adjacent example: LG 135

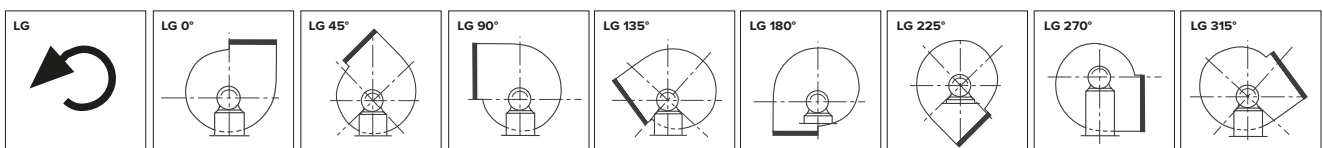



DIMENSIONS

C 10 ÷ C 45

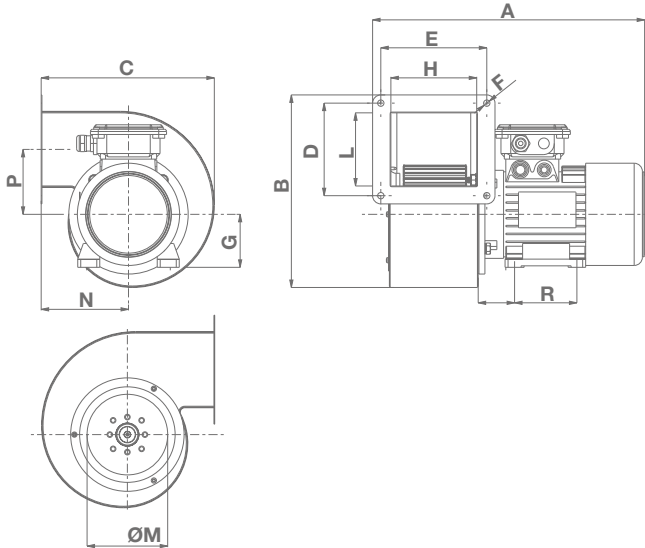

C 46

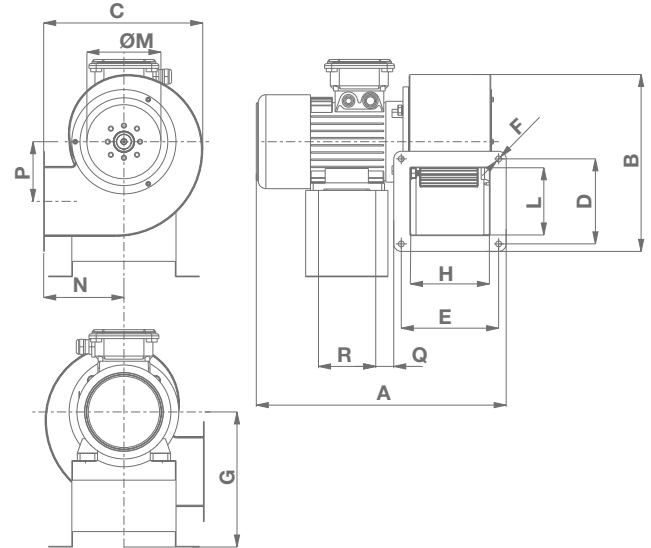

PRODUCTS	A	ØB	C	D	E	F	G	H	L	ØM	N	P	Q	R
C 10/2* M - T	260	186	171	72	82	6.5	56	68	63	80	81	66.5	36	71
C 15/2* M - T	281	234	206	108	100	7	56	83	88	108	99	79	36	71
C 20/2* M - T	350	258	232	123	123	8.5	71	102	98	108	117	87	45	90
C 25/2* M	369	258	232	124	142	8.5	71	115	98	108	117	87	45	90
C 25/2* T	358	258	232	124	142	8.5	71	115	98	108	117	87	45	90
C 30/2* M - T	366	308	272	126	137	8.5	71	117	108	132	131	111	45	90
C 30/4* M - T	352	308	272	126	137	8.5	71	117	108	132	131	111	45	90
C 31/4** T	357	400	340	164	139	8.5	71	112	137	170	152	144	45	90
C 35/4** M	390	400	340	164	174	8.5	71	149	137	170	152	144	45	90
C 35/4** T	387	400	340	164	174	8.5	71	149	137	170	152	144	45	90
C 37/4** M	437	471	416.5	220	182	8.5	80	149	187	199	181.5	146	50	100
C 37/4** T	422	471	416.5	220	182	8.5	80	149	187	199	181.5	146	50	100
C 40/4** M	468	472	418	214	208	8.5	80	185	187	199	181.5	147	50	100
C 40/4** T	453	472	418	214	208	8.5	80	185	187	199	181.5	147	50	100
C 45/4** T	549	557.2	484.5	228	228	9	90	200	200	240	222	217	56	125
C 46/4** T	592	675	566	306	265	11.5	442	236	277	288	250	244.5	27	270

* normally supplied with an orientation of the auger clockwise LG 90 ** normally supplied with an orientation of the auger clockwise LG 270 °

Dimensions (mm)



DIMENSIONS

AIR INTAKE

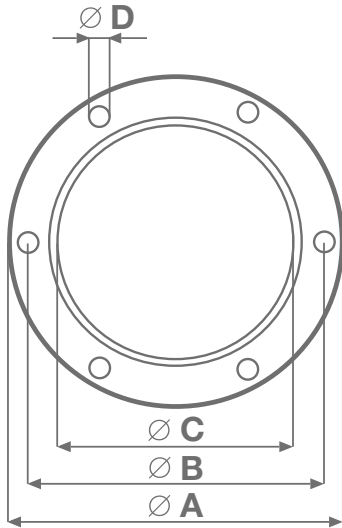

DELIVERY OUTLET

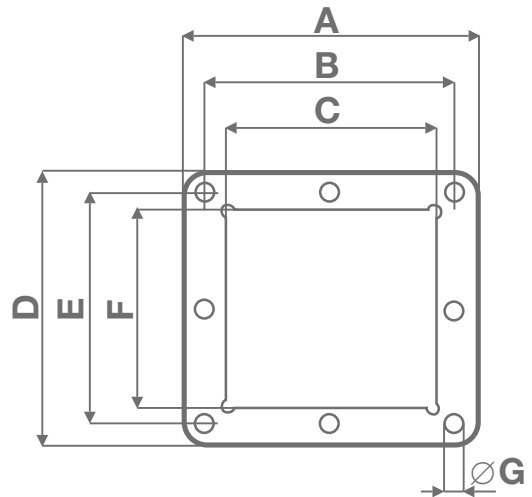

PRODUCTS	ØA	ØB	ØC	ØD	N° HOLES
C 10	111.5	100	80	7	6
C 15	141	128	108	7	6
C 20 E	152	132	108	7	6
C 25 E	152	132	108	7	6
C 30 E	190	170	132	7	6
C 31 E	240	220	170	7	8
C 35 E	240	220	170	8.5	8
C 37 E	282	262	199	8.5	8
C 40 E	282	262	199	4.6	8
C 45 E	320	300	236	8.5	8
C 46 E	420	395	288	12	8

Dimensions (mm)

PRODUCTS	A	B	C	D	E	F	ØG	N° HOLES
C 10	98	82	68	88	72	63	6.5	4
C 15	125	100	83	132	108	88	7	4
C 20 E	145	123	102	145	123	98	8.5	4
C 25 E	164	142	115	146	124	98	8.5	4
C 30 E	162	137	117	150	126	108	8.5	4
C 31 E	165	139	112	190	164	137	8.5	8
C 35 E	200	174	149	190	164	137	8.5	8
C 37 E	218	182	149	250	220	187	8.5	8
C 40 E	244	208	185	250	214	187	8.5	8
C 45 E	260	228	200	260	228	200	9	8
C 46 E	295	264	236	336	306	277	11.5	8

Dimensions (mm)



PERFORMANCE CURVES

C 10/2 M

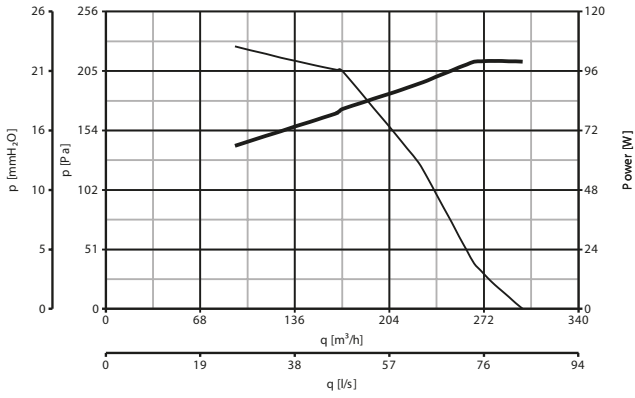

C 15/2 M

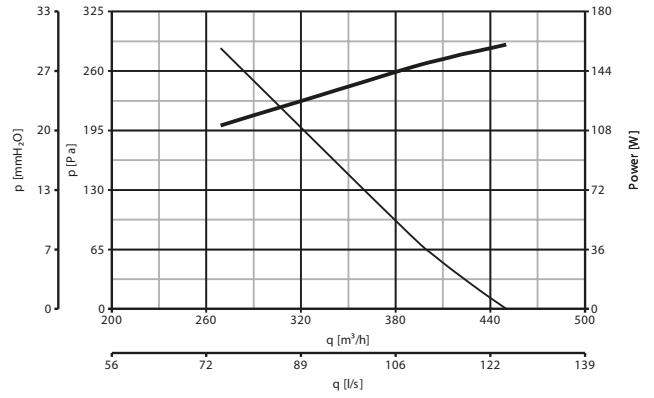

C 20/2 M E

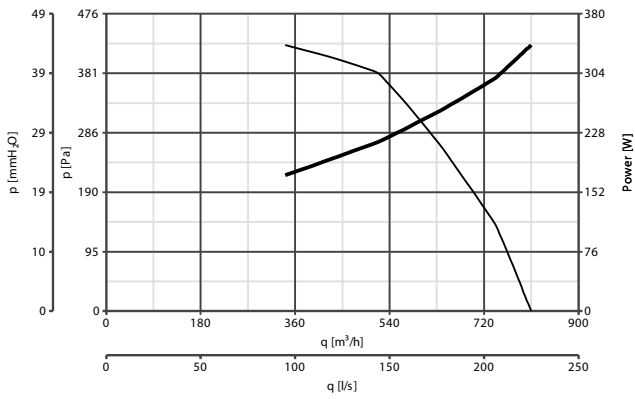

C 25/2 M E

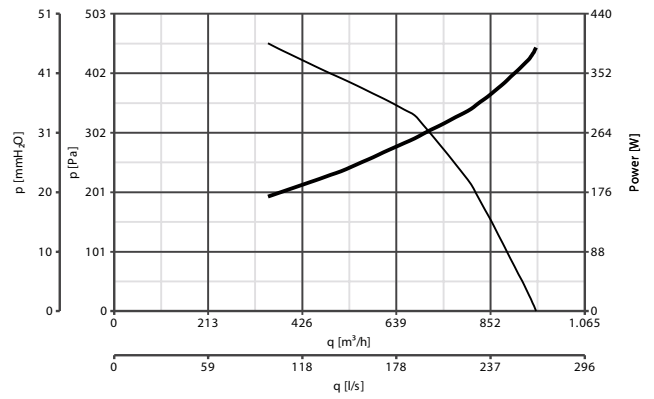

C 30/2 M E

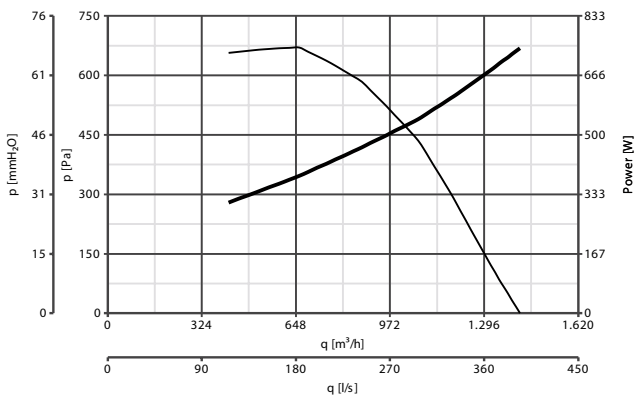

C 30/4 M E

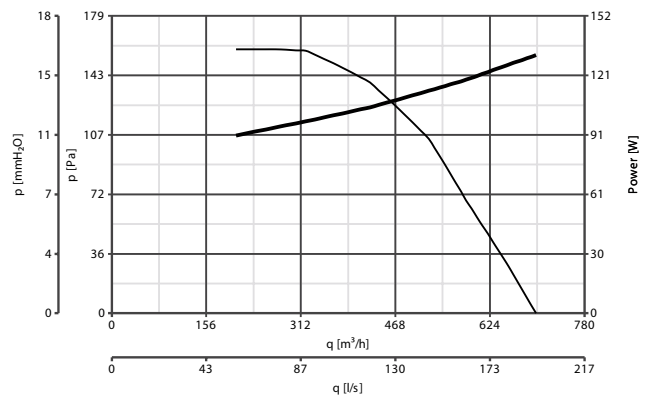

Power consumption
 Delivery



PERFORMANCE CURVES

C 35/4 M E

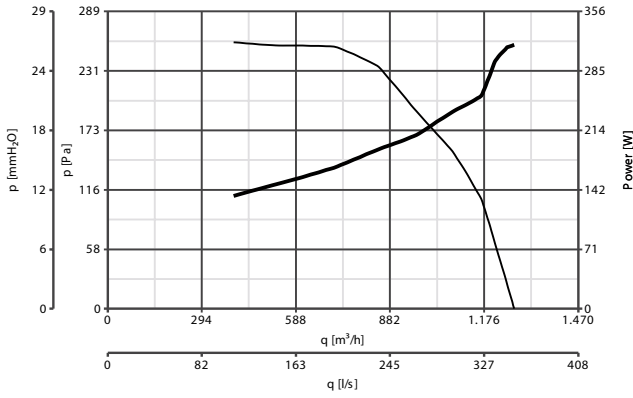

C 37/4 M E

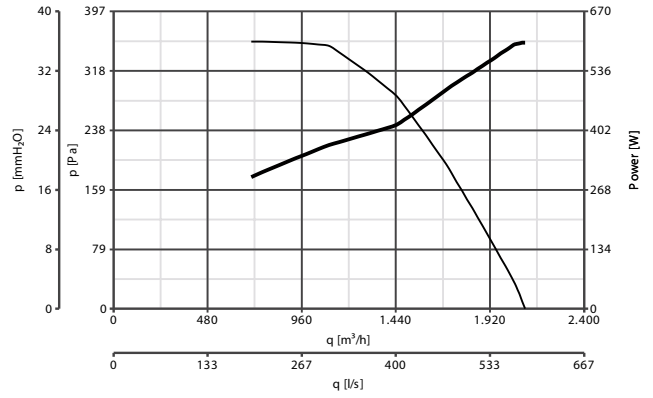

C 40/4 M E

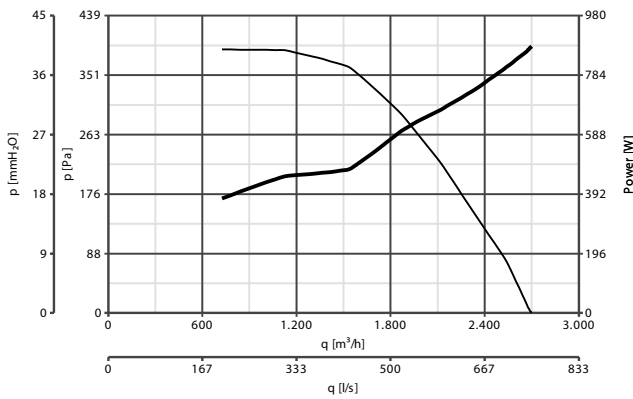

C 10/2 T

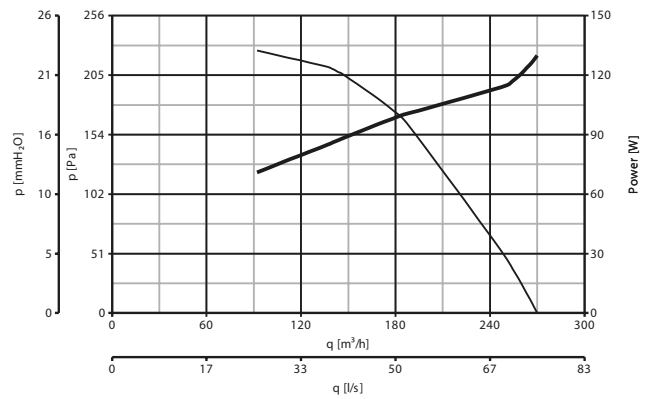

C 15/2 T

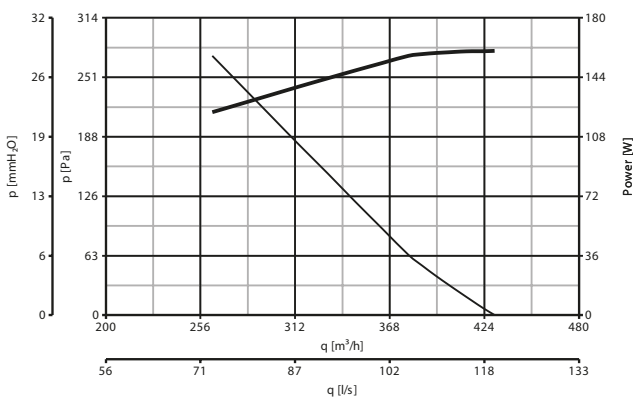

C 20/2 T E

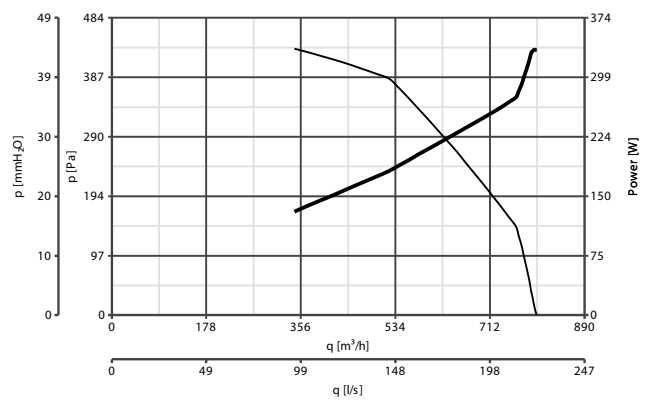

— Power consumption
— Delivery



PERFORMANCE CURVES

C 25/2 T E

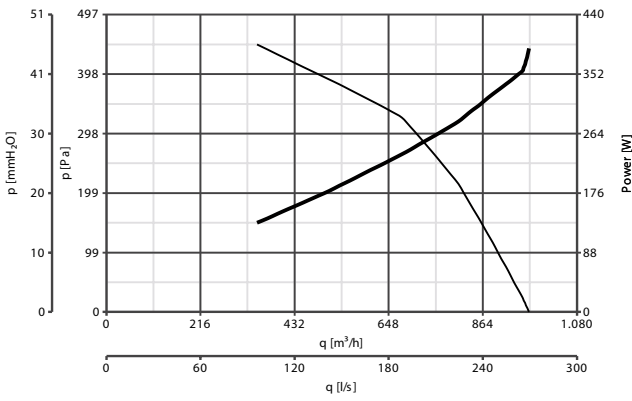

C 30/2 T E

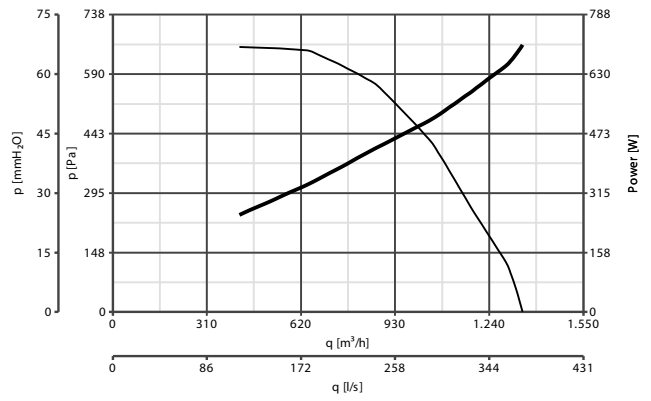

C 30/4 T E

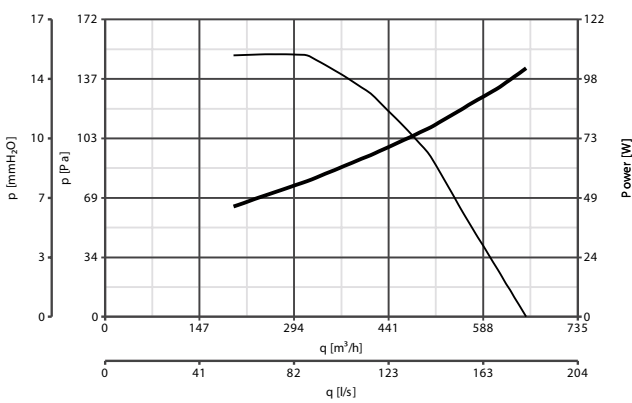

C 31/4 T E

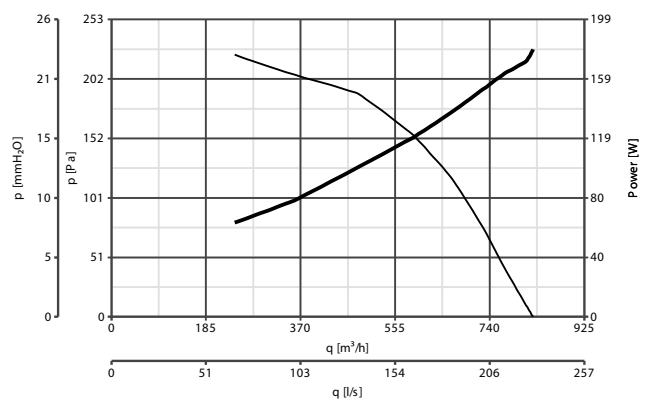

C 35/4 T E

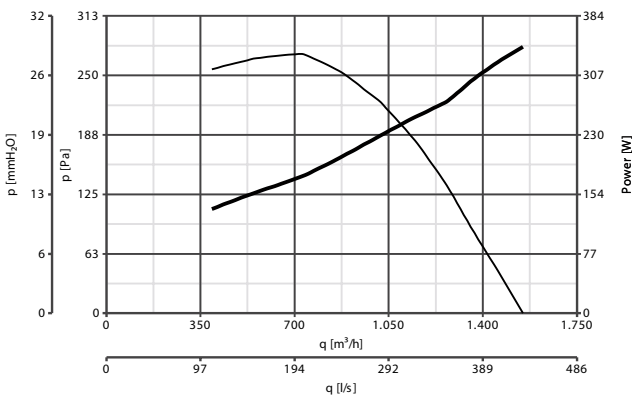

C 37/4 T E

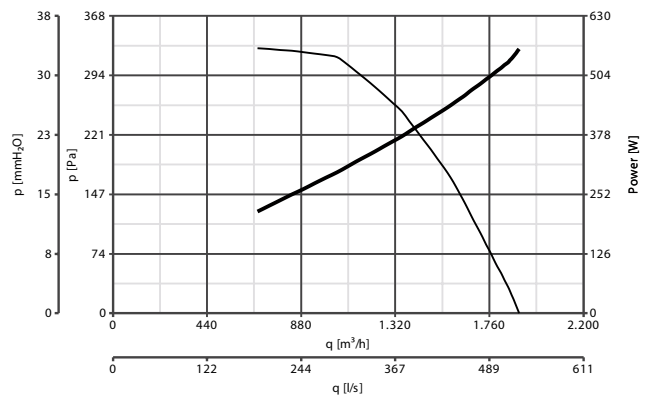

— Power consumption
— Delivery



INDUSTRIAL VENTILATION

VORTICENT C E RANGE

PERFORMANCE CURVES

C 40/4 T E

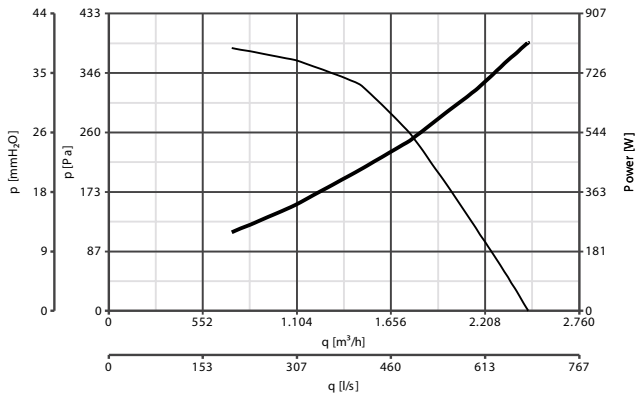

C 45/4 T E

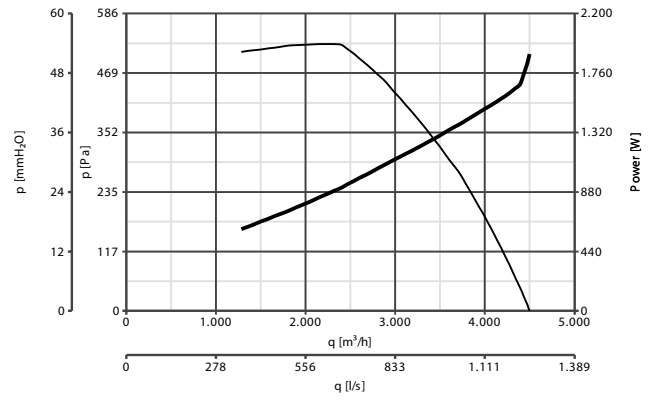



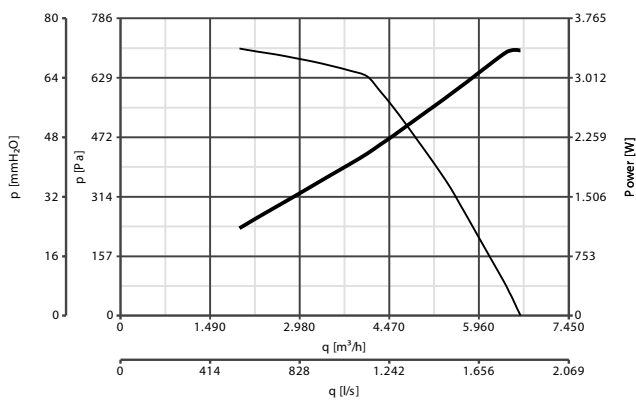

C 46/4 T E



— Power consumption
— Delivery



ACCESSORIES



MODELS	DESCRIPTION	CODE	PRODUCTS
	C RA - Flanged inlet adapter	10	22825 30302 - 30351
		15	22826 30902 - 30951
		20/25	22828 30321 - 30322 - 30323 - 30324
		30	22829 30325 - 30326 - 30327 - 30328
		31/35	22830 30329 - 30330 - 30331
		37	22832 30332 - 30333
		40	22833 30334 - 30335
		45	22834 30336
		46	22835 30337
	C MS - Wall-mounted support	20/25	22836 30321 - 30322 - 30323 - 30324
		30	22837 30325 - 30326 - 30327 - 30328
		31/35	22838 30329 - 30330 - 30331
		37/40	22839 30332 - 30334 - 30333 - 30335
		45	22840 30336
	C GM - Protection grille for outlet port	10	22811 30302 - 30351
		15	22812 30902 - 30951
		20	22813 30321 - 30322
		25	22814 30323 - 30324
		30	22816 30325 - 30326 - 30327 - 30328
		31	22817 30329
		35	22818 30330 - 30331
		37	22819 30332 - 30333
		40	22820 30334 - 30335
		45	22821 30336
	C GA - Protection grille for intake port	10	22801 30302 - 30351
		15	22802 30902 - 30951
		20/25	22803 30321 - 30322 - 30323 - 30324
		30	22804 30325 - 30326 - 30327 - 30328
		31/35	22805 30329 - 30330 - 30331
		37/40	22806 30332 - 30334 - 30333 - 30335
		45	22807 30336
		46	22808 30337



INDUSTRIAL VENTILATION

VORTICENT C E RANGE

CONTROLLERS

MODELS	DESCRIPTION	CODE	PRODUCTS
	IREM INVERTER 4 M - Single-phase speed controller with inverter*	12815	30302 - 30902 - 30321 - 30323 - 30325 - 30327 - 30330 - 30332
	IREM INVERTER 6 M - Single-phase speed controller with inverter*	12818	30334
	IRET INVERTER 2.5 M - Three-phase speed controller with inverter*	12816	30351 - 30951 - 30322 - 30324 - 30326 - 30328 - 30329 - 30331 - 30333 - 30335
	IRET INVERTER 5 M - Three-phase speed controller with inverter*	12817	30336
	IRET INVERTER 8 M - Three-phase speed controller with inverter	12821	30337
	POT - Potentiometer	12828	12815 - 12816 - 12817 - 12818

* To adjust a regulator with inverter, combine a 0-10V potentiometer as code 12828







E-ATEX RANGE

Axial plate-mounted fans for installation in potentially explosive areas

Industrial wall or ceiling-mounted axial fans. Available in different diameters and in single or three phase versions, built and certified by IMQ in compliance with the EN 14986 standard, which governs the design of fans operating in potentially explosive atmospheres due to the presence of gases or powders (premises intended for storage of fuels, sawmills and sugar refineries).

Key features

- Robust and weatherproof construction.
- Wide range of applications:
 - ATEX classification: "II 2G h T3 X" (use in areas with a presence of potentially explosive gases).
 - ATEX classification: "II 2D h T125 X" (use in areas with a presence of potentially explosive powders).
- Motors with very high (IP65) degree of protection against dust and water.

Versions

- 14 models, in single and three-phase versions, with 4 and 6 poles, with a nominal diameter between 250 and 600 mm.

Technical features

- Frames with nozzle and mesh in pickled and phosphate steel sheet, treated initially with epoxy base coat; the grey textured finish is obtained by applying a coat of polyurethane powder paint strengthened by furnace baking.
- Class F asynchronous UNELMEC B35 standard size motors with shafts turning on ball bearings with double sealing screen, characterized by high (IP65) degree of protection against dust and water. The measures taken and materials used in manufacturing are those suitable for use in potentially explosive atmospheres, according to Explosion Protection standards EN 60079-0, EN 60079-7, EN 61241-0 and EN 61241-1.
- Starting capacitors of the single-phase models comply with the EN 60252-1 standard and are third-party certified.
- Galvanised sheet steel motor covers.
- Metal cable glands for connection to the ATEX certified mains network.
- Aluminium cooling fans.
- Safety and anti-bird protective grilles made of galvanised steel rings, protected by double surface coating.
- Impellers with die-cast aluminium hubs and blades moulded in antistatic polyamide resin loaded with glass fibres to combine dimensional stability, strength and resistance to aggressive agents.

Note

The classification and identification of installation environments for fans of the VORTICE E ATEX range, like all fans for explosive atmospheres, must be performed by the appropriate authorities

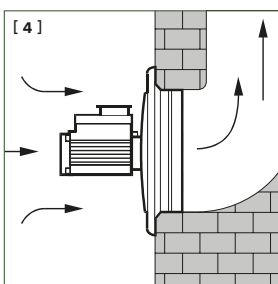
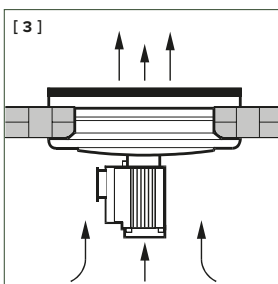
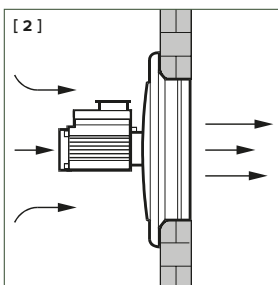

[1] Robust construction.
 [2] [3] [4] These devices can be installed on walls, ceilings and even in ducts.



TECHNICAL DATA

	PRODUCTS	CODE	V~50HZ	W	A	POLES	RPM	MAX AIRFLOW		MAX PRESSURE		Lp dB(A)* 3 m	MAX °C**	KG
								m³/h	l/s	mmH ₂ O	Pa			
SINGLE-PHASE	E 254 M ATEX	40301	230	167	0.75	4	1400	1040	288.9	8.9	87.5	63.2	40	8.0
	E 304 M ATEX	40302	230	175	0.77	4	1400	1600	444.4	14.0	137.3	59.6	40	8.8
	E 354 M ATEX	40304	230	204	0.97	4	1400	2220	616.7	17.3	169.4	66.0	40	9.5
	E 404 M ATEX	40306	230	294	1.27	4	1400	3550	986.1	19.8	193.8	62.0	40	11.5
	E 454 M ATEX	40308	230	346	1.50	4	1400	4634	1287.2	19.1	187.6	70.0	40	14.0
THREE-PHASE	E 254 T ATEX	40309	400	121	0.49	4	1400	1050	291.7	9.6	94.2	59.6	40	7.0
	E 304 T ATEX	40310	400	162	0.53	4	1400	1585	440.3	14.1	138.3	62.0	40	8.0
	E 354 T ATEX	40313	400	208	0.50	4	1400	2550	708.3	18.4	180.5	66.0	40	8.8
	E 404 T ATEX	40314	400	268	0.61	4	1400	3480	966.7	17.4	170.3	64.8	40	10.5
	E 454 T ATEX	40315	400	345	0.70	4	1400	4443	1234.7	18.2	178.3	69.8	40	13.6
	E 504 T ATEX	40316	400	293	0.64	4	1400	4900	1361.1	17.7	173.8	72.7	40	13.6
	E 506 T ATEX	40319	400	166	0.47	6	1000	3823	1061.9	10.1	99.2	64.0	40	14.5
	E 604 T ATEX	40317	400	374	0.71	4	1400	6900	1916.7	20.8	203.7	75.4	40	18.0
E 606 T ATEX	40318	400	223	0.49	6	1000	5715	1587.5	12.2	119.4	65.5	40	19.5	

*Sound pressure level measured at 3 m in free field conditions in accordance with standard ISO 3741.

** Maximum continuous operating temperature of the product.





INDUSTRIAL VENTILATION

E-ATEX RANGE

DIMENSIONS

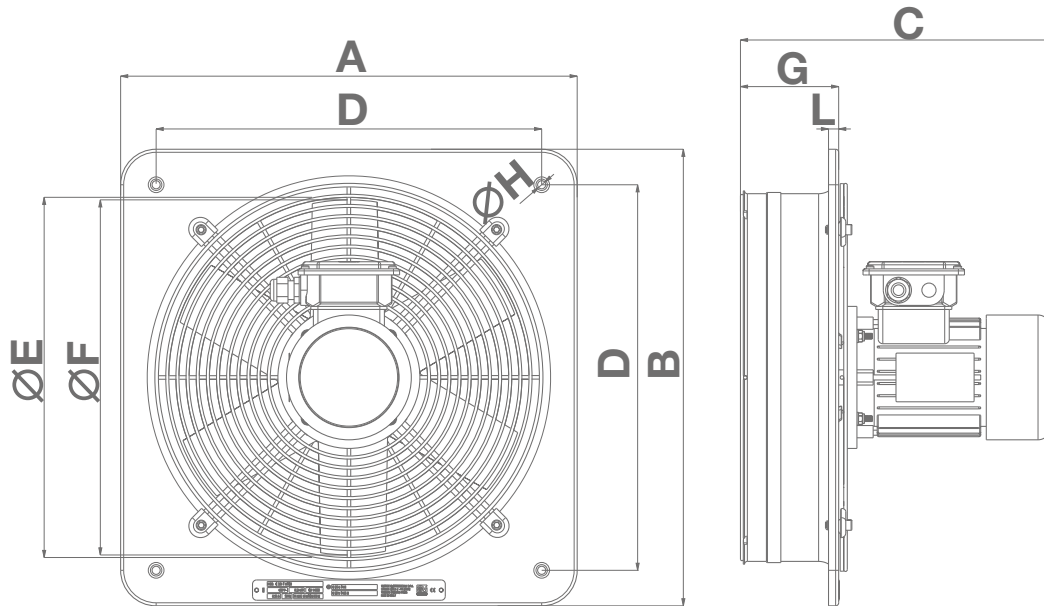

PRODUCTS	Ønom	A	B	C	D	ØE	ØF	G	ØH	L
E 254 ATEX M - T	250	320	320	305	280	256	250	95	8	10
E 304 ATEX M - T	315	380	380	307	330	308	300	97	8	10
E 354 ATEX M - T	355	450	450	307	380	360	350	97	8	10
E 404 ATEX M - T	400	510	510	327	430	410	400	117	12	15
E 454 ATEX M - T	450	630	630	325	530	460	448	112	12	15
E 504 ATEX T	500	630	630	325	530	510	498	112	12	15
E 506 ATEX T	500	630	630	361	530	510	498	112	12	15
E 604 ATEX T	630	760	760	340	630	610	598	127	12	15
E 606 ATEX T	630	760	760	361	630	610	598	127	12	15

Dimensions (mm)



PERFORMANCE CURVES

E 254 M ATEX

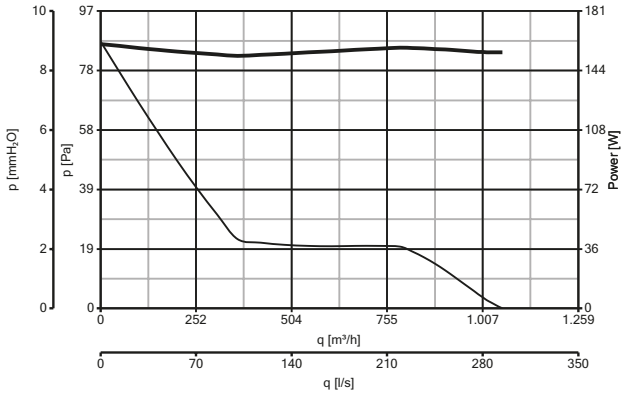

E 304 M ATEX

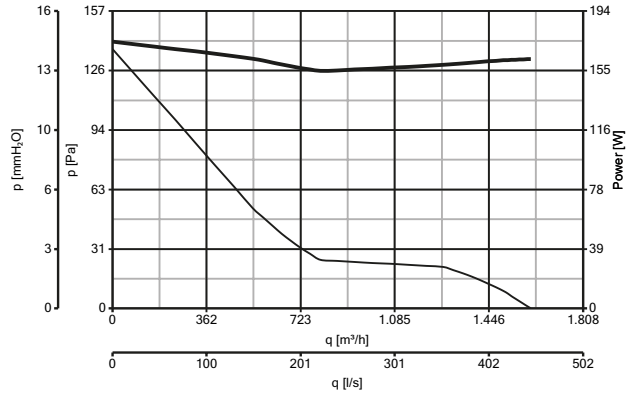

E 354 M ATEX

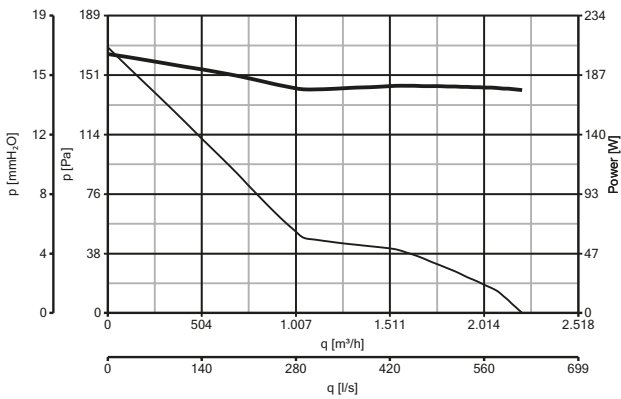

E 404 M ATEX

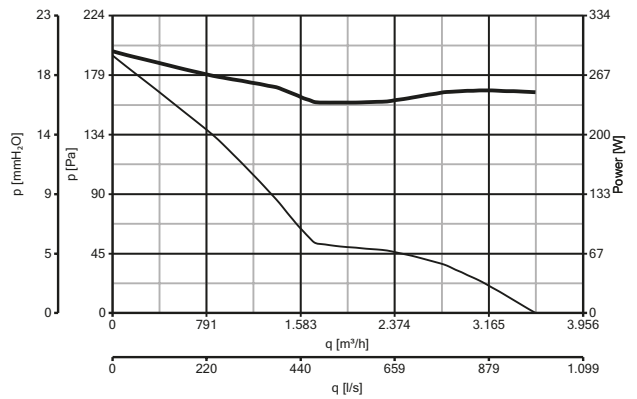

E 454 M ATEX

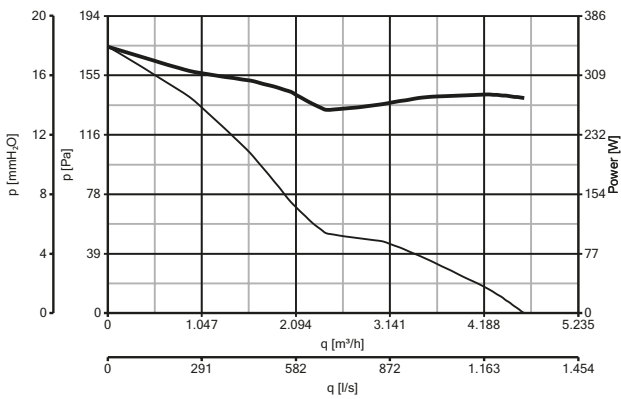

E 254 T ATEX

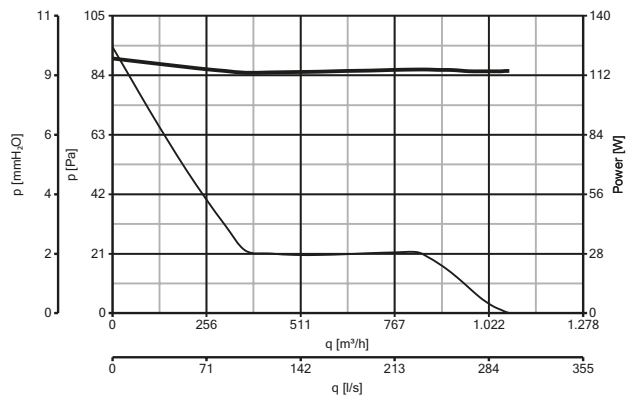

— Power consumption
— Delivery



PERFORMANCE CURVES

E 304 T ATEX

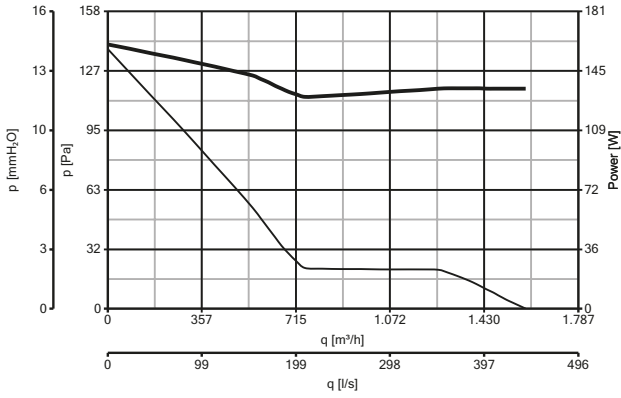

E 354 T ATEX

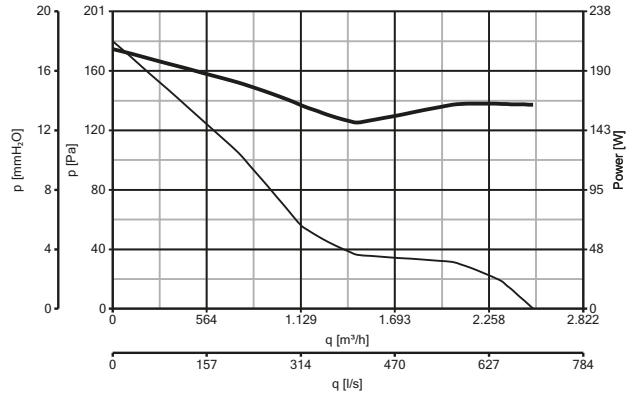

E 404 T ATEX

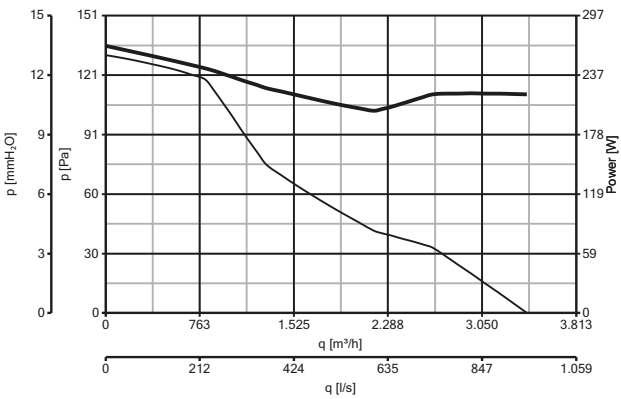

E 454 T ATEX

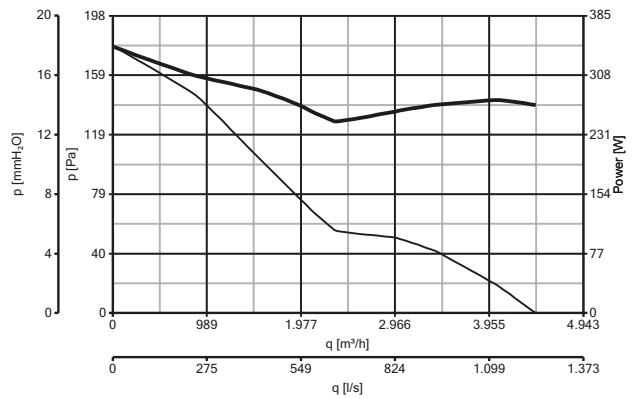

E 504 T ATEX

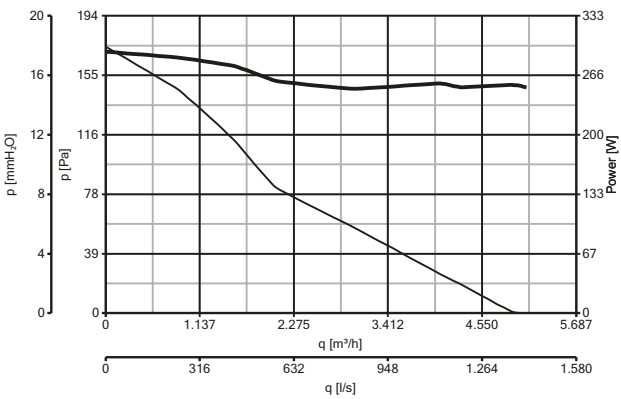

E 506 T ATEX

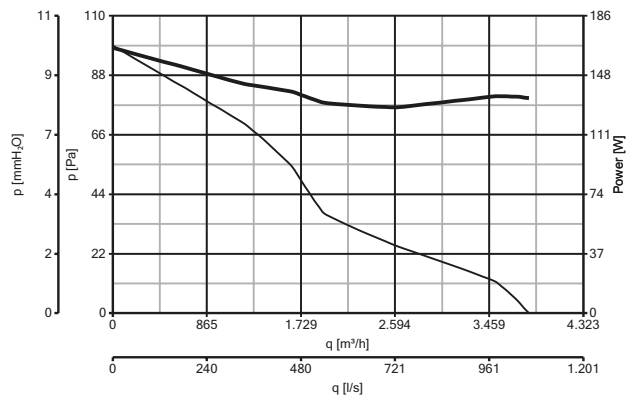

— Power consumption
— Delivery



PERFORMANCE CURVES

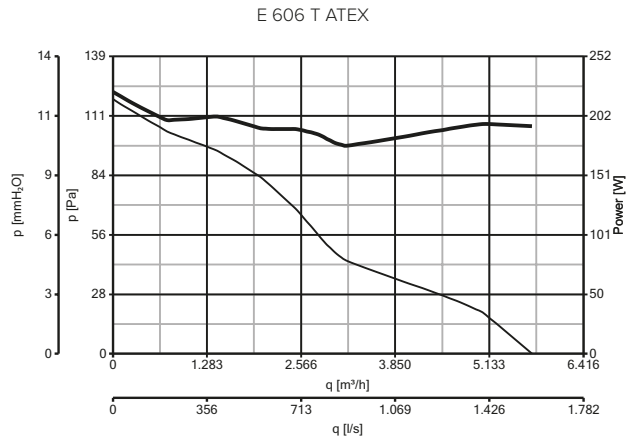
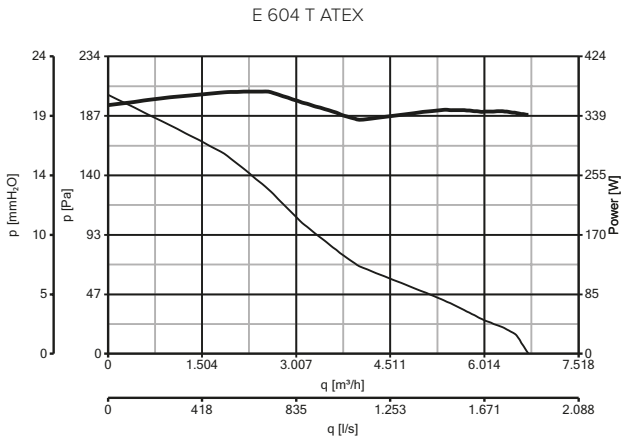

— Power consumption
— Delivery

CONTROLLERS

MODELS	DESCRIPTION	CODE	PRODUCTS
	GV2 ME04 - Thermal-magnetic motor circuit breakers	21113	40309 - 40310 - 40313 - 40317 - 40319
	GV2 ME05 - Thermal-magnetic motor circuit breakers	21114	40301 - 40302 - 40304 - 40315 - 40316 - 40318
	GV2 ME06 - Thermal-magnetic motor circuit breakers	21115	40306 - 40308





C-ATEX RANGE

Centrifugal fans for installation in potentially explosive areas



Industrial three-phase centrifugal fans, built and certified by IMQ in compliance with the EN 14986 standard which governs the design of fans operating in potentially explosive atmospheres due to the presence of gases or dust, such as premises intended for the storage of fuels, sawmills and sugar refineries.

Key features

- Robust and weatherproof construction.
- Wide range of applications:
 - Atex classification: "II 2G h T3 X" (use in areas with a presence of potentially explosive gases).
 - Atex classification: "II 2D h T125 X" (use in areas with a presence of potentially explosive powders).
- Motors with very high (IP65) degree of protection against dust and water.

Versions

9 models, all three-phase versions, with 2 and 4 poles.

Technical features

- Scrolls complete with coupling flange to the downstream piping, in pickled and phosphated steel sheet, treated initially with epoxy base coat; the grey textured finish is obtained by applying a coat of polyurethane powder paint strengthened by furnace baking. A set of holes allows for appropriate orientation of the delivery spigots.
- Copper ventilation ports, calibrated to optimize airflow.
- Galvanised steel mesh over the ventilation ports, black epoxy powder-coated and furnace-baked.
- Class F three-phase asynchronous UNELMEC B35 standard size motors with shafts turning on ball bearings with double sealing screen, characterized by high (IP65) degree of protection against dust and water. The measures taken and materials used in manufacturing are those suitable for use in potentially explosive atmospheres, in accordance with Explosion Protection standards EN 60079-0, EN 60079-7, EN 61241-0 and EN 61241-1.
- Galvanised sheet steel motor covers.
- Metal cable glands for connection to the ATEX certified mains network.
- Aluminium cooling fans.
- Centrifugal impellers with forward blades made of steel sheet, dynamically balanced (UNI ISO 1940, Class 6.3).

Note

The classification and identification of installation environments for the fans of the VORTICENT C ATEX range, like all fans for explosive atmospheres, must be performed by the appropriate authorities.

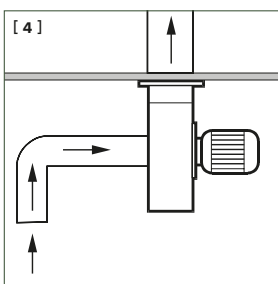
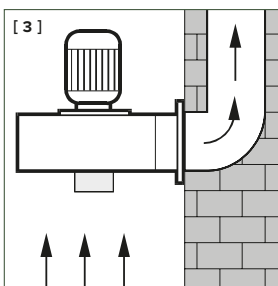
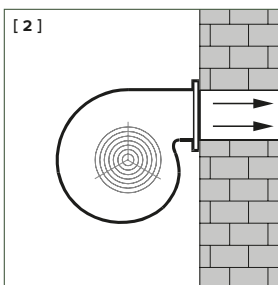
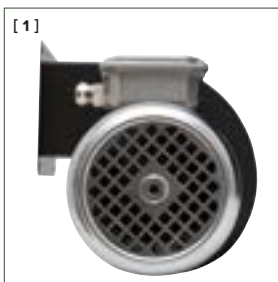

[1] Robust construction.
 [2] [3] [4] These devices can be installed on walls, ceilings and even in ducts.



TECHNICAL DATA

	PRODUCTS	CODE	V~50HZ	W	A	POLES	RPM	MAX AIRFLOW		MAX PRESSURE		Lp dB(A)* 3 m	MAX °C**	KG
								m³/h	l/s	mmH ₂ O	Pa			
THREE-PHASE	C 10/2 T ATEX	30301	400	120	0.36	2	2800	280	77.8	26	255	55.5	40	4
	C 15/2 T ATEX	30304	400	175	0.39	2	2800	430	119.4	44	430	59.0	40	4.5
	C 20/2 T ATEX	30305	400	472	1.09	2	2800	1000	277.8	56	549	66.0	40	8.5
	C 25/2 T ATEX	30306	400	482	1.10	2	2800	1100	305.6	67	657	66.5	40	8.5
	C 30/2 T ATEX	30307	400	902	1.57	2	2800	1350	375.0	83	814	71.0	40	10
	C 30/4 T ATEX	30308	400	226	0.95	4	1400	700	194.4	18	177	55.0	40	7.5
	C 31/4 T ATEX	30309	400	375	1.01	4	1400	1120	311.1	31	304	61.0	40	10.5
	C 35/4 T ATEX	30310	400	401	1.02	4	1400	1500	416.7	34	334	61.0	40	11.5
	C 37/4 T ATEX	30311	400	803	1.80	4	1400	2150	597.2	48	470	70.0	40	17

*Sound pressure level measured at 3 m in free field conditions in accordance with standard ISO 3741.

** Maximum continuous operating temperature of the product.





DIMENSIONS

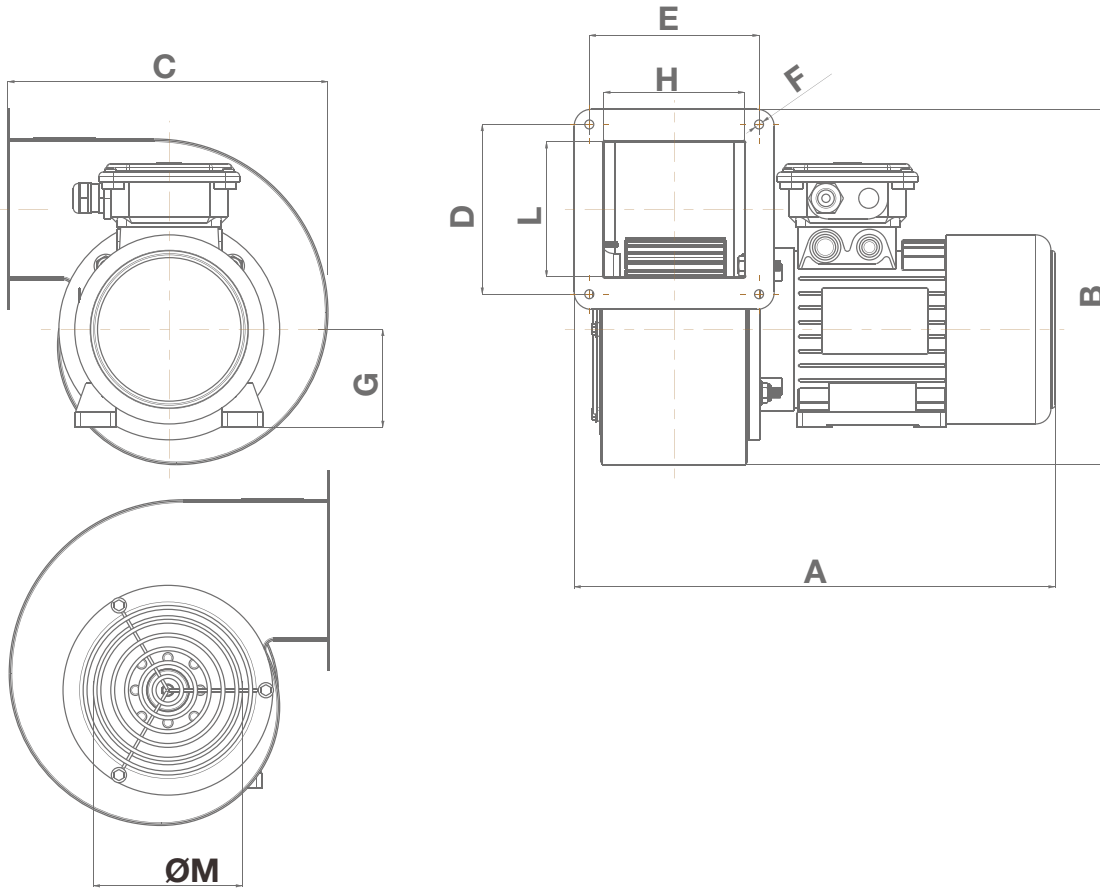

PRODUCTS	A	B	C	D	E	F	G	H	L	ØM
C 10/2 T ATEX	260	186	171	72	82	6.5	56	68	63	80
C 15/2 T ATEX	280	234	206	108	100	7	56	83	88	108
C 20/2 T ATEX	350	258	232	123	123	8.5	71	102	98	108
C 25/2 T ATEX	365	258	232	124	142	8.5	71	115	98	108
C 30/2 T ATEX	365	308	272	126	137	8.5	71	117	108	132
C 30/4 T ATEX	365	308	272	126	137	8.5	71	117	108	132
C 31/4 T ATEX	365	400	340	164	139	8.5	71	112	137	170
C 35/4 T ATEX	400	400	340	164	174	8.5	71	149	137	170
C 37/4 T ATEX	425	471	416.5	220	182	8.5	80	149	187	199

Dimensions (mm)



PERFORMANCE CURVES

C 10/2 T ATEX

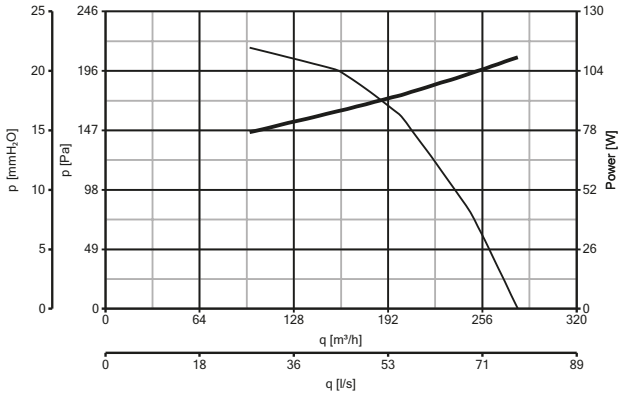

C 15/2 T ATEX

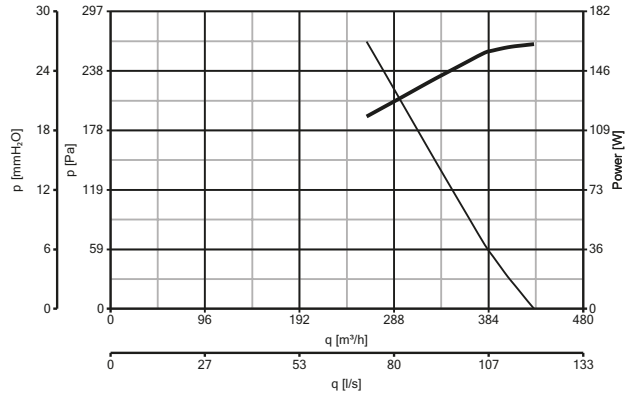

C 20/2 T ATEX

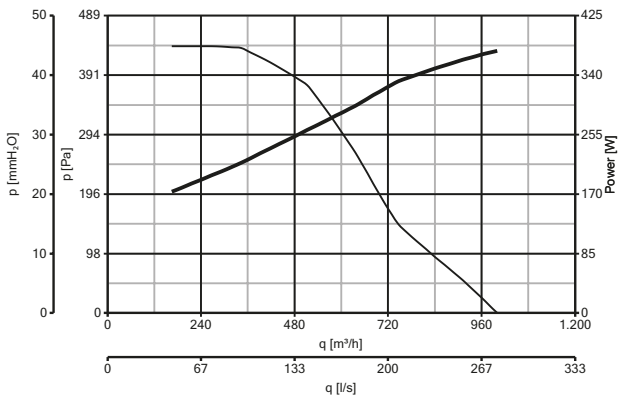

C 25/2 T ATEX

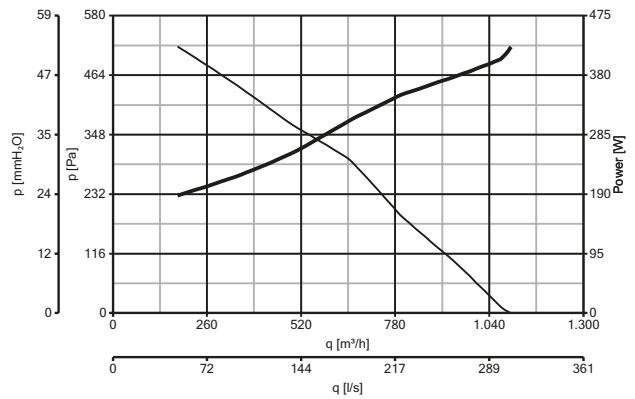

C 30/2 T ATEX

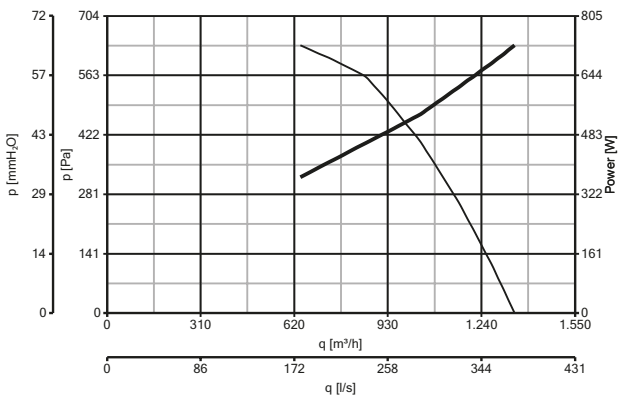

C 30/4 T ATEX

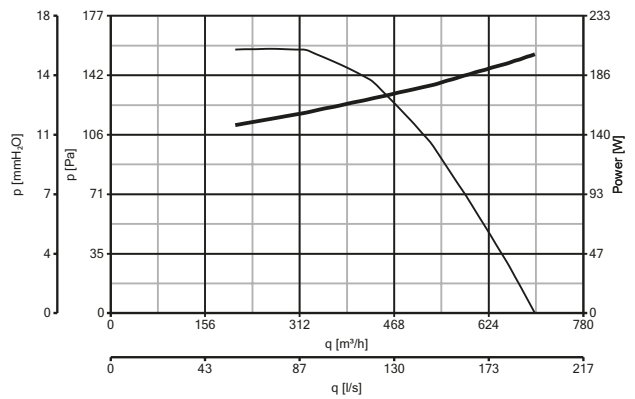

— Power consumption
— Delivery



PERFORMANCE CURVES

C 31/4 T ATEX

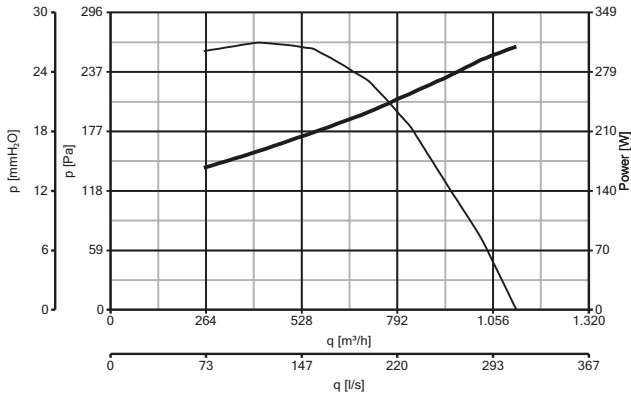

C 35/4 T ATEX

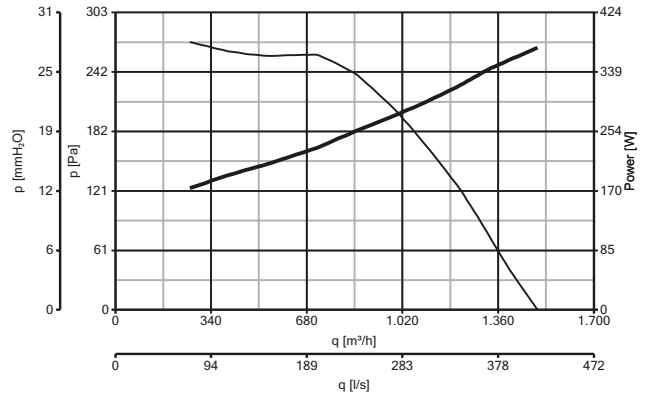

C 37/4 T ATEX

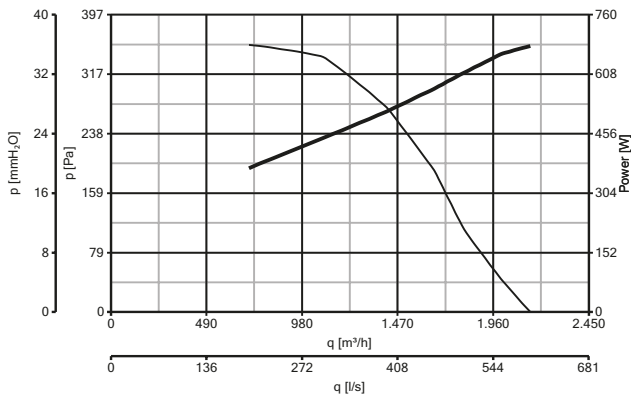

— Power consumption
- - - Delivery

ACCESORIES

MODELS	DESCRIPTION	CODE	PRODUCTS
		10	21031 30301
		15	21032 30304
		20/25	21033 30305 - 30306
		30	21034 30308
		31/35	21035 30309 - 30310
		37	21036 30311



C RA - Suction fitting



CONTROLLERS

MODELS	DESCRIPTION	CODE	PRODUCTS
	GV2 ME - Thermal-magnetic motor circuit breakers	21112	30301 - 30304
	GV2 ME05 - Thermal-magnetic motor circuit breakers	21114	30308
	GV2 ME06 - Thermal-magnetic motor circuit breakers	21115	30305 - 30306 - 30307 - 30309 - 30310
	GV2 ME07 - Thermal-magnetic motor circuit breakers	21136	30311



TORRETTE RF-EU RANGE

Centrifugal roof fans with horizontal discharge



Roof-mounted centrifugal fans with radial discharge and reduced vertical clearance. Available in different diameters and in single and three-phase versions, designed for the ventilation of civil and industrial environments such as gyms, restaurants, offices, theatres, discos, hospitals and factories.

Key features

- Robust and weatherproof construction.
- Easy installation on a wide range of roof types, thanks to the reduced vertical clearance.
- Designed to operate in high environmental temperatures ($\geq 50\text{ }^{\circ}\text{C}$), in compliance with typical application requirements for hot climates.

Versions

15 models, in single and three phase versions, with 4, 6 and 8 poles.

Technical features

- Motor cover made of pickled and phosphated steel sheet, polyester powder coated and furnace-baked, guaranteeing higher long-term resistance to aggressive agents, in grey colour with hammered finish.
- Galvanised steel sheet ventilation port, calibrated to optimize airflow.
- Safety and anti-bird protective grilles designed in accordance with the UNI ISO 13857 standard, made of electrically welded steel rings with epoxy black paint finish.
- Class F thermally protected asynchronous motors, single or three-phase depending on the model, with shafts turning on ball bearings, speed adjustable by Vortice controllers.
- Starting capacitors of the single-phase models comply with the EN 60252-1 standard and are third-party certified.
- Centrifugal impellers with galvanised steel sheet, self-cleaning, backward curved blades, dynamically balanced (UNI ISO 1940, Class 6.3).
- Wiring boxes complete with moulded cable glands in thermoplastic resin.
- Steel eye-bolts for lifting and transport, protected from corrosion by galvanic treatment.
- Steel cables for secure anchoring of the product to the destination surfaces supplied as standard.

Note

- The fans mounted in the torrette RF-EP range towers comply with Reg. ErP No. 327/2011/UE.
- The towers in the torrette RF-EP range comply with Reg. ErP No. 1253/2014/UE.
- The towers in the torrette RF-EP range are not suitable for handling flows characterized by significant concentrations of abrasive powders or acid or corrosive substances.

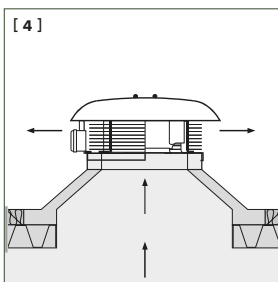
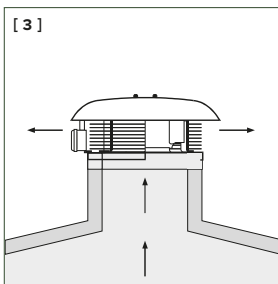
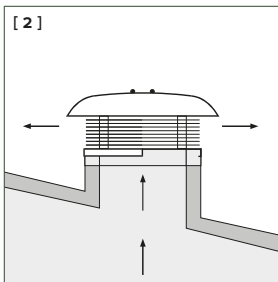
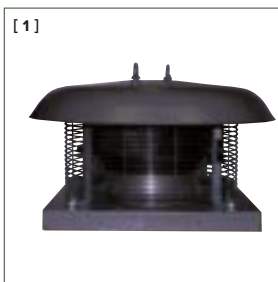

[1] Front view. [2] [3] [4] These devices are easily installed on top of each roof. The air must not be dusty, acidic or corrosive.



TECHNICAL DATA

	PRODUCTS	CODE	V~50HZ	W	A	POLES	RPM	MAX AIRFLOW		MAX PRESSURE		Lp dB(A)* 3 m	MAX °C**	KG
								m³/h	l/s	mmH ₂ O	Pa			
SINGLE-PHASE	RF-EU M15 4P	15121	230	119	0.52	4	1450	1460	405	24.1	236	37.0	60	14.8
	RF-EU M20 4P	15122	230	168	0.78	4	1426	2150	597	25.1	246	34.1	60	15.5
	RF-EU M30 4P	15123	230	500	1.3	4	1200	3760	1044	34.7	340	43.6	60	29.1
	RF-EU M70 4P	15125	230	999	5.20	4	1380	7200	2000	40.4	396	53.0	60	32.0
THREE-PHASE	RF-EU T10 4P	15126	400	90	0.21	4	1367	1350	375	20.7	203	30.5	60	15.0
	RF-EU T15 4P	15127	400	137	0.28	4	1387	1810	503	25.9	254	37.7	60	16.2
	RF-EU T20 4P	15128	400	416	0.63	4	1360	3750	937	23.9	323	44.0	60	22.3
	RF-EU T30 4P	15129	400	440	0.88	4	1300	4000	1111	50.4	494	38.7	60	29.3
	RF-EU T50 4P	15130	400	540	1.20	4	1290	5040	1400	31.5	309	52.0	60	32.2
	RF-EU T70 4P	15131	400	540	1.20	4	1290	5050	1405	29.4	288	47.0	60	33.0
	RF-EU T70 6P	15132	400	712	1.57	6	900	8100	2250	40.7	399	43.8	60	57.0
	RF-EU T100 4P	15133	400	2500	4.60	4	1330	13275	3687	57.8	567	55.0	60	60.0
	RF-EU T100 6P	15134	400	1385	3.40	6	920	13000	3611	33.5	329	51.0	60	66.0
	RF-EU T100 8P	15135	400	2970	4.5	8	1230	16000	4444	87.0	853	64.2	60	81.0
	RF-EU T150 6P	15136	400	3765	5.75	6	1340	17000	4722	111.0	1090	64.0	60	81.0

*Sound pressure level measured at 3 m in free field conditions in accordance with standard ISO 3741.

** Maximum continuous operating temperature of the product.



ENERGY DATA PURSUANT TO REGULATION N° 1253/2014/EU

	UNIT OF MEASUREMENT	RF-EU M15 4P	RF-EU M20 4P	RF-EU M30 4P	RF-EU M70 4P	RF-EU T10 4P
CODE		15121	15122	15123	15125	15126
Manufacturer's name or brand name	-	Vortice	Vortice	Vortice	Vortice	Vortice
Type of ventilation unit declared	-	UVNR-U**	UVNR-U**	UVNR-U**	UVNR-U**	UVNR-U**
Type of drive	-	VM***	VM***	VSD***	VM***	VM***
Type of heat exchanger system HRS	-	none	none	none	none	none
Heat efficiency of the heat recovery	%	NA*	NA*	NA*	NA*	NA*
Nominal flow rate	m ³ /s	0.2481	0.45194	0.945	1.750	0.22194
Effective electric power input	kW	0.119	0.162	0.229	0.999	0.090
SFPint ****	W/(m ³ /s)	NA*	NA*	NA*	NA*	NA*
Face velocity at nominal flow rate	m/s	9.74797	13.04838	18.07601	21.35715	8.72187
Nominal external pressure (Δp_s , ext)	Pa	119	114	69	153	112
Internal pressure drop of the ventilation components (Δp_s , int)	Pa	24	11	29	97	21
Internal pressure drop of the non-ventilation components (Δp_s , add)	Pa	0	0	0	0	0
Static efficiency in the nominal point of the ventilation unit (η_{FAN})	%	30.0	34.9	40.4	43.8	32.8
Maximum percentage of internal leakage of the case	%	NA*	NA*	NA*	NA*	NA*
Maximum percentage of external leakage of the case	%	NA*	NA*	NA*	NA*	NA*
Energy performance or energy classification of the filters	-	NA*	NA*	NA*	NA*	NA*
Description of the visual filter warning	-	NA*	NA*	NA*	NA*	NA*
Sound power LWA on the case	dB(A)	58	55	64	74	51

*NA Not Applicable. ** UVNR-U: Non-Residential Ventilation Unit - Unidirectional. *** VM: Multiple Speed. **** SFPint: Specific internal power of the ventilation components. ****VSD: with variable speed drive



ENERGY DATA PURSUANT TO REGULATION N° 1253/2014/EU

	UNIT OF MEASUREMENT	RF-EU T15 4P	RF-EU T20 4P	RF-EU T30 4P	RF-EU T50 4P	RF-EU T70 4P
CODE		15127	15128	15129	15130	15131
Manufacturer's name or brand name	-	Vortice	Vortice	Vortice	Vortice	Vortice
Type of ventilation unit declared	-	UVNR-U**	UVNR-U**	UVNR-U**	UVNR-U**	UVNR-U**
Type of drive	-	VM***	VM***	VM***	VM***	VM***
Type of heat exchanger system HRS	-	none	none	none	none	none
Heat efficiency of the heat recovery	%	NA*	NA*	NA*	NA*	NA*
Nominal flow rate	m ³ /s	0.49528	0.6144	0.82861	1.125	1.125
Effective electric power input	kW	0.113	0.306	0.429	0.540	0.53
SFPint ****	W/(m ³ /s)	NA*	NA*	NA*	NA*	NA*
Face velocity at nominal flow rate	m/s	15.30266	11.31049	14.91069	15.49942	15.49942
Nominal external pressure (Δp_s , ext)	Pa	39	200	162	144	147
Internal pressure drop of the ventilation components (Δp_s , int)	Pa	46	3	41	62	61
Internal pressure drop of the non-ventilation components (Δp_s , add)	Pa	0	0	0	0	0
Static efficiency in the nominal point of the ventilation unit (η_{FAN})	%	37.3	40.8	39.2	42.9	44.2
Maximum percentage of internal leakage of the case	%	NA*	NA*	NA*	NA*	NA*
Maximum percentage of external leakage of the case	%	NA*	NA*	NA*	NA*	NA*
Energy performance or energy classification of the filters	-	NA*	NA*	NA*	NA*	NA*
Description of the visual filter warning	-	NA*	NA*	NA*	NA*	NA*
Sound power LWA on the case	dB(A)	58	65	59	68	68

*NA Not Applicable. ** UVNR-U: Non- Residential Ventilation Unit - Unidirectional. *** VM: Multiple Speed. **** SFPint: Specific internal power of the ventilation components. *****VSD: with variable speed drive



ENERGY DATA PURSUANT TO REGULATION N° 1253/2014/EU

	UNIT OF MEASUREMENT	RF-EU T70 6P	RF-EU T100 4P	RF-EU T100 6P	RF-EU T100 8P	RF-EU T150 6P
CODE		15132	15133	15134	15135	15136
Manufacturer's name or brand name	-	Vortice	Vortice	Vortice	Vortice	Vortice
Type of ventilation unit declared	-	UVNR-U**	UVNR-U**	UVNR-U**	UVNR-U**	UVNR-U**
Type of drive	-	VM***	VM***	VM***	VSD***	VSD***
Type of heat exchanger system HRS	-	none	none	none	none	none
Heat efficiency of the heat recovery	%	NA*	NA*	NA*	NA*	NA*
Nominal flow rate	m ³ /s	1.56444	2.75	3	3.19056	3.42556
Effective electric power input	kW	0.698	2.5	1.385	2.936	3.7
SFPint ****	W/(m ³ /s)	NA*	NA*	NA*	NA*	NA*
Face velocity at nominal flow rate	m/s	15.28467	20.13589	17.81843	24.40373	26.20118
Nominal external pressure (Δp_s , ext)	Pa	178	342	148	481	577
Internal pressure drop of the ventilation components (Δp_s , int)	Pa	8	158	77	20	41
Internal pressure drop of the non-ventilation components (Δp_s , add)	Pa	0	0	0	0	0
Static efficiency in the nominal point of the ventilation unit (η_{FAN})	%	41.7	55.0	48.7	54.4	57.2
Maximum percentage of internal leakage of the case	%	NA*	NA*	NA*	NA*	NA*
Maximum percentage of external leakage of the case	%	NA*	NA*	NA*	NA*	NA*
Energy performance or energy classification of the filters	-	NA*	NA*	NA*	NA*	NA*
Description of the visual filter warning	-	NA*	NA*	NA*	NA*	NA*
Sound power LWA on the case	dB(A)	64	76	72	85	85

*NA Not Applicable. ** UVNR-U: Non- Residential Ventilation Unit - Unidirectional. *** VM: Multiple Speed. **** SFPint: Specific internal power of the ventilation components. *****VSD: with variable speed drive



DIMENSIONS

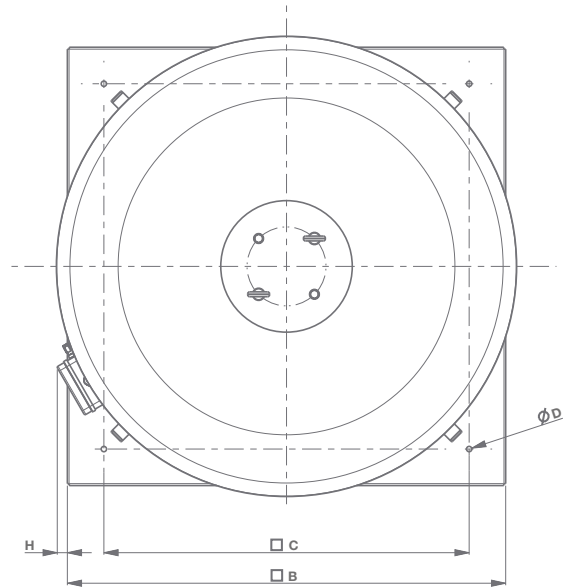
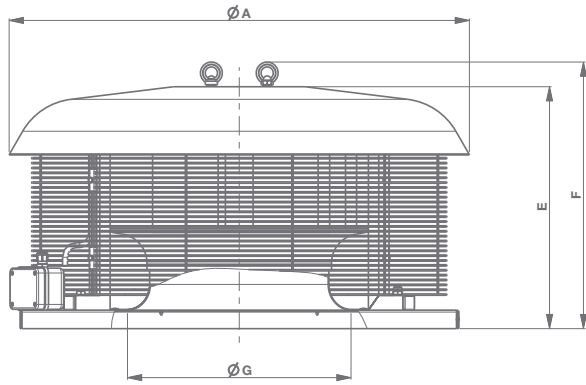

PRODUCTS	ØA	ØB	ØC	ØD	E	F	ØG	H
RF-EU M15 4P	540	410	357	11	255	293	235	69
RF-EU M20 4P	540	410	357	11	282	320	248	69
RF-EU M30 4P	720	550	500	11	341	380	314	75
RF-EU M70 4P	720	600	500	11	400	451	402	76
RF-EU T10 4P	540	410	357	11	256	295	235	69
RF-EU T15 4P	540	410	357	11	282	321	255	69
RF-EU T20 4P	720	550	500	11	330	369	314	69
RF-EU T30 4P	720	550	500	11	338	378	325	69
RF-EU T50 4P	720	550	500	11	355	393	360	69
RF-EU T70 4P	720	550	500	11	398	436	402	69
RF-EU T70 6P	945	900	750	11	497	548	460	21
RF-EU T100 4P	945	900	750	11	455	506	496	21
RF-EU T100 6P	945	900	750	11	493	544	553	21
RF-EU T100 8P	945	900	750	11	501	552	496	37
RF-EU T150 6P	945	900	750	11	501	552	496	37

Dimensions (mm)



INDUSTRIAL VENTILATION

TORRETTE RF-EU RANGE

PERFORMANCE CURVES

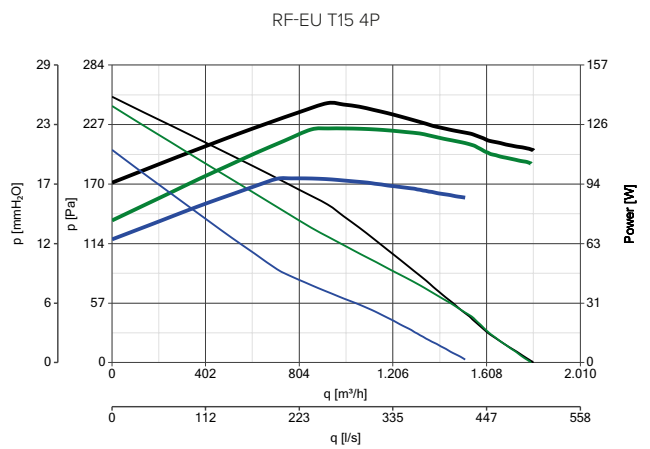
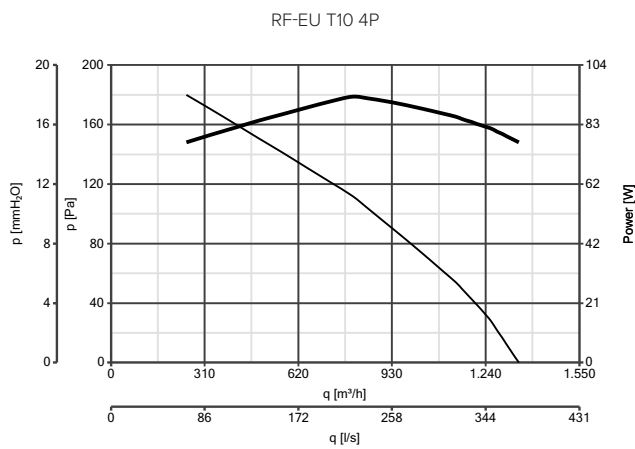
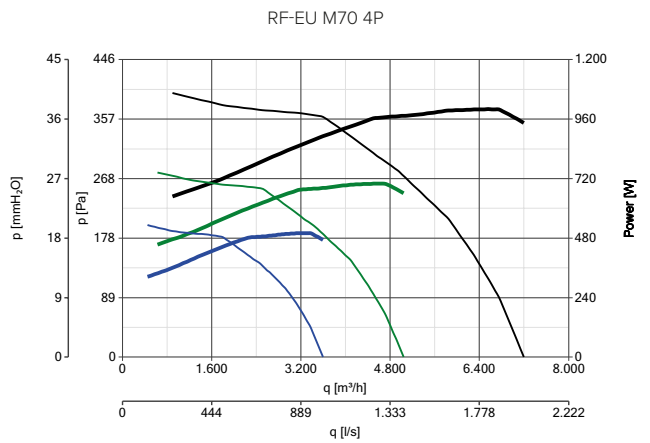
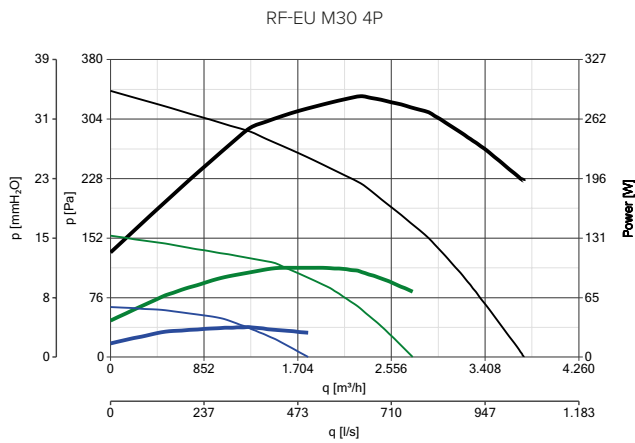
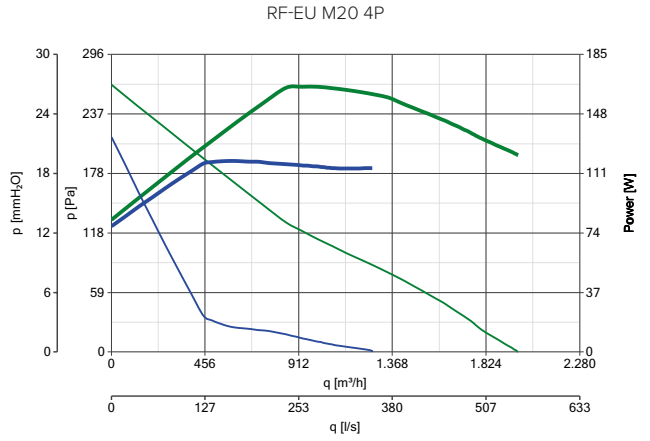
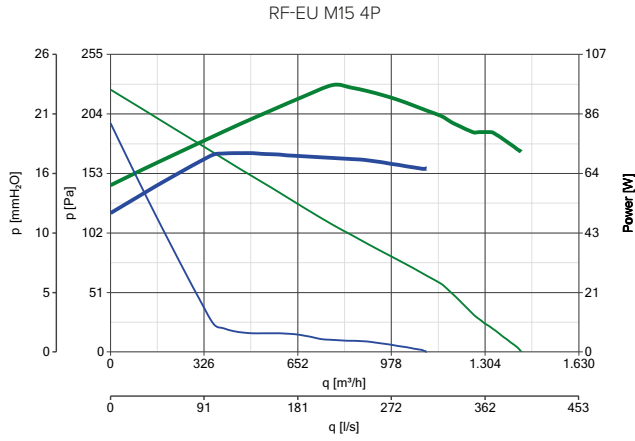

POWER CONSUMPTION
 — max
 — med
 — min

PERFORMANCE CURVES
 — max
 — med
 — min



PERFORMANCE CURVES

RF-EU T20 4P

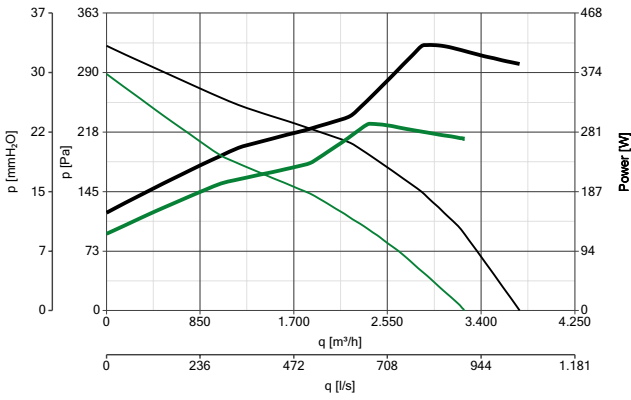

RF-EU T30 4P

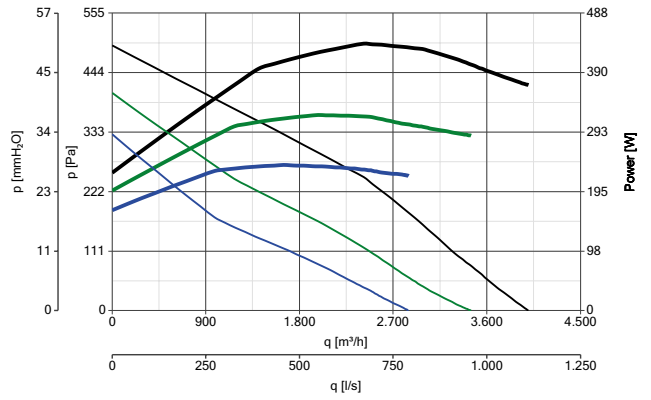

RF-EU T50 4P

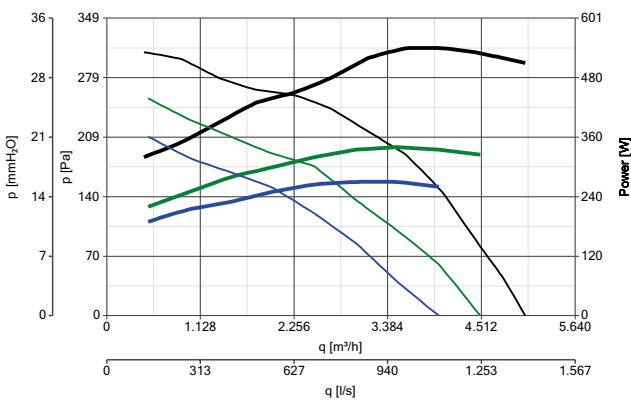

RF-EU T70 4P

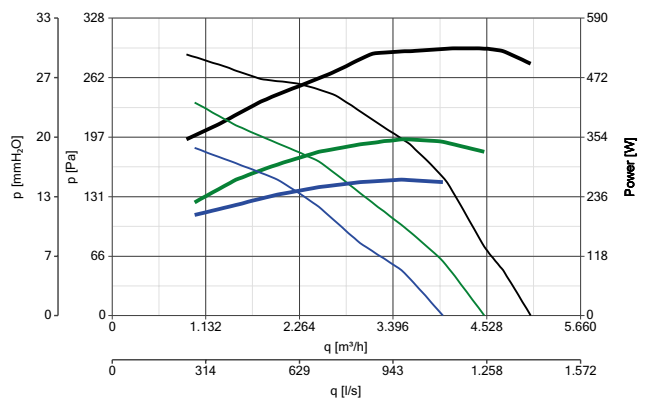

RF-EU T70 6P

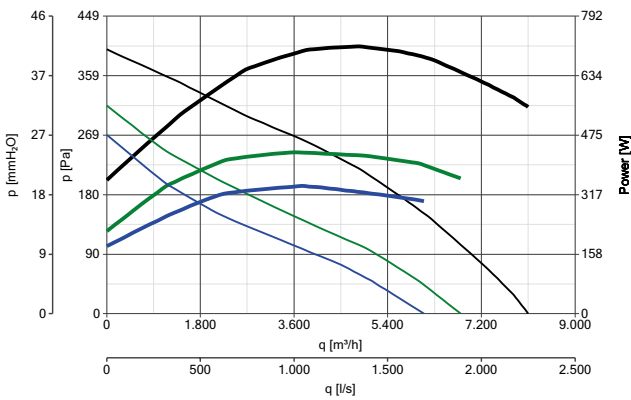

RF-EU T100 4P

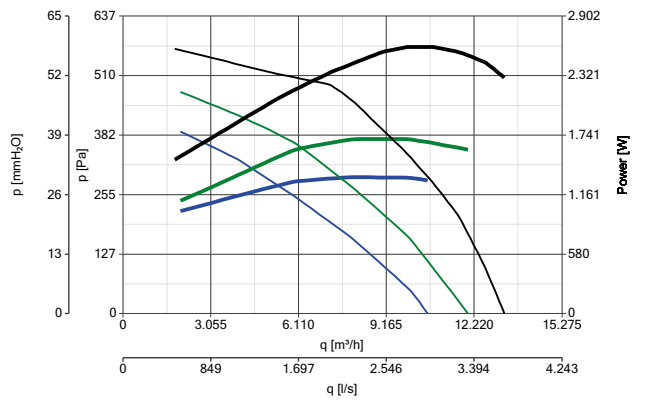

POWER CONSUMPTION
 — max
 — med
 — min

PERFORMANCE CURVES
 — max
 — med
 — min



INDUSTRIAL VENTILATION

TORRETTE RF-EU RANGE

PERFORMANCE CURVES

RF-EU T100 6P

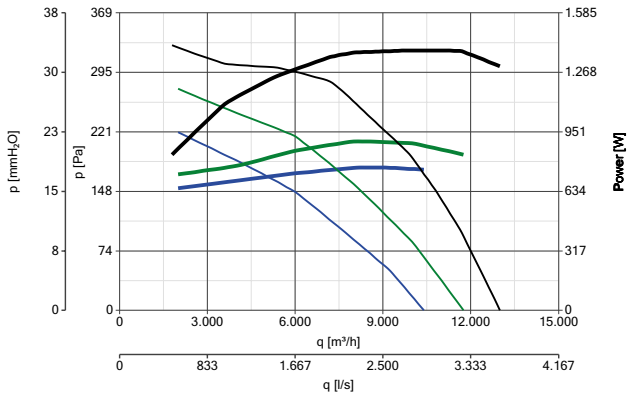

RF-EU T100 8P

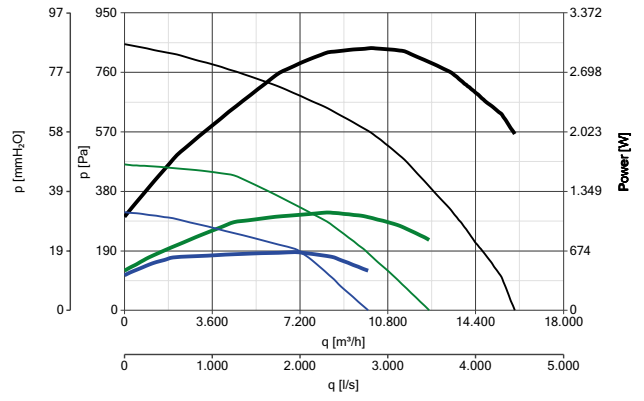

RF-EU T150 6P

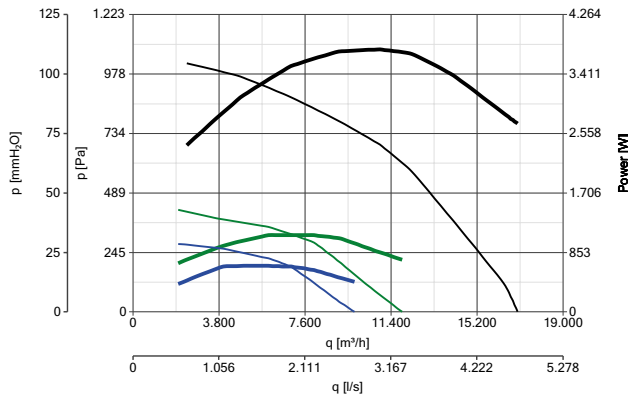





POWER CONSUMPTION PERFORMANCE CURVES



— max — max
 — med — med
 — min — min



ACCESSORIES

MODELS	DESCRIPTION	CODE	PRODUCTS	
	TR-CU - Sub-frame	10/15	22511	15121 - 15122 - 15126 - 15127
		20/30/50	22512	15123 - 15125 - 15128 - 15129 - 15130 - 15131
		70/100	22539	15132 - 15133 - 15134 - 15135 - 15136
	TR-S - Backdraught shutter	20/30/50	22510	15121 - 15122 - 15126 - 15127
		70/100	22541	15123 - 15125 - 15128 - 15129 - 15130 - 15131
		100/150/180/210	22542	15132 - 15133 - 15134 - 15135 - 15136
	TR-B - Suction connector	20/30/50	22610	15121 - 15122 - 15126 - 15127
		70/100	22508	15123 - 15125 - 15128 - 15129 - 15130 - 15131
		100/150/180/210	22509	15132 - 15133 - 15134 - 15135 - 15136
	TR-G - Intake port protection grille	20/30/50	22710	15121 - 15122 - 15126 - 15127
		70/100	22506	15123 - 15125 - 15128 - 15129 - 15130 - 15131
		100/150/180/210	22507	15132 - 15133 - 15134 - 15135 - 15136

CONTROLLERS

MODELS	DESCRIPTION	CODE	PRODUCTS
	IRM 30 - Three position single-phase speed controller	12921	15121 - 15122
	IRM 70 - Three position single-phase speed controller	12837	15125
	IRT 15 - Three position single-phase speed controller	12923	15126 - 15127 - 15128
	IRT 35 - Three position single-phase speed controller	12924	15129 - 15130 - 15131 - 15132
	IRT 40 - Three position single-phase speed controller	12927	15134
	IRT 100 - Three position single-phase speed controller	12838	15133
	POT - Potentiometer	12828	15123 - 15135 - 15136

* Can control multiple fans up to a maximum 5A.

** Used for simultaneous control of multiple appliances up to maximum 9A.



TORRETTE TR-E RANGE

Centrifugal roof fans for horizontal discharge

Roof-mounted centrifugal fans with radial discharge, available in different diameters and in single and three-phase versions, designed for the ventilation of civil and industrial environments such as gyms, restaurants, offices, theatres, discos, hospitals and factories.

Key features

- Robust and, weatherproof construction.
- Designed to operate in high environmental temperatures ($\geq 70^{\circ}\text{C}$), in compliance with typical application requirements for hot climates.
- Wide range of performance.

Versions

20 models, in single and three-phase version, with 4, 6 and 8 poles.

Technical features

- Bases made of pickled and phosphated steel sheet, grey epoxy powder-coated with hammered finish.
- Motor cover made of pickled and phosphated steel sheet, polyester powder-coated and furnace-baked, guaranteeing higher long-term resistance to aggressive agents over time, in grey colour with hammered finish.
- Ventilation ports, fashioned in one piece with the body, characterized by aerodynamic profiles, calibrated to optimize the extracted airflow.
- Safety and anti-bird protective grilles designed in accordance with the UNI ISO 13857 standard, made of electrically welded steel rings and epoxy black paint finish.
- Galvanised steel sheet motor plates, designed to divert the flow of air handled, preventing it from striking the drive unit directly and thus protecting it from excessive heat loads.
- Class F or H thermally protected single or three-phase asynchronous motors, depending on the model, with shafts turning on ball bearings with double sealing screen, characterized by high (IP55) degree of protection against dust and water and with cooling fans for more effective heat dissipation.
- Starting capacitors of the single-phase models comply with the EN 60252-1 standard and are third-party certified.
- Centrifugal impellers with electrically galvanised aluminium or steel sheet, depending on the model, self-cleaning, backward-curved blades, dynamically balanced (UNI ISO 1940, Class 6.3), fitted on grooved hubs in die-cast aluminium.
- Wiring boxes complete with moulded cable glands in thermoplastic resin.
- Steel eye-bolts for lifting and transport, protected from corrosion by galvanic treatment.
- Steel cables for secure anchoring of the product to the destination surfaces supplied as standard.

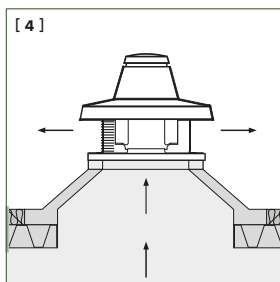
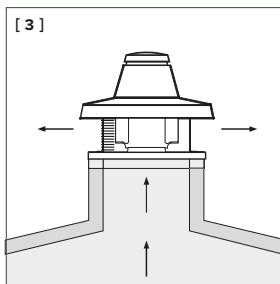
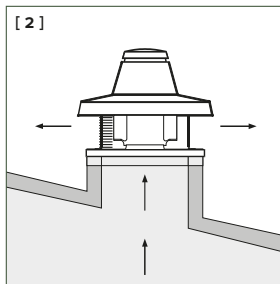

[1] Engine detail. [2] [3] [4] These devices are easily installed on top of each roof. The air must not be dusty, acidic or corrosive.

Note

- The fans mounted in the torrette TR E range towers comply with Reg. ErP No. 327/2011/UE.
- The fans of the torrette TR E range towers comply with Reg. ErP No. 1253/2014/UE.
- The towers of the torrette TR E range are not suitable for handling flows characterized by significant concentrations of abrasive dust or acid or corrosive substances.



TECHNICAL DATA

	PRODUCTS	CODE	V~50HZ	W	A	POLES	RPM	MAX AIRFLOW		MAX PRESSURE		Lp dB(A) 3 m	MAX °C*	KG
								m³/h	l/s	mmH ₂ O	Pa			
SINGLE-PHASE	TRM 10 E 4P	15115	220-240	100	0.50	4	1400	1100	306	22	216	56	90	14.5
	TRM 15 E 4P	15205	220-240	150	0.70	4	1400	1440	389	26	255	58.5	80	15
	TRM 20 E 4P	15216	220-240	280	1.30	4	1415	2600	722	36	353	62	85	22
	TRM 30 E 4P	15356	220-240	400	1.80	4	1425	3300	917	44	432	67	70	23
	TRM 50 E 4P	15556	220-240	800	3.70	4	1480	4800	1333	55	540	72.5	80	28
	TRM 70 E 4P	15070	220-240	1000	4.35	4	1415	6400	1778	67.5	662	77	90	79
	TRT 10 E 4P	15155	400	100	0.30	4	1400	1100	306	22	216	56	90	14.5
THREE-PHASE	TRT 15 E 4P	15255	400	150	0.30	4	1400	1400	389	26	255	58.5	90	15
	TRT 20 E 4P	15215	400	300	0.60	4	1400	2700	750	35	343	62	90	22
	TRT 30 E 4P	15355	400	400	0.75	4	1400	3200	889	46	451	67	90	23
	TRT 50 E 4P	15555	400	800	1.45	4	1400	4900	1361	61	598	72.5	90	28
	TRT 70 E 4P	15071	400	950	1.85	4	1440	6400	1778	69	674	77	90	77
	TRT 70 E 6P	15072	400	600	1.30	6	950	7000	1944	38	373	74	90	80
	TRT 100 E 4P	15073	400	1900	3.25	4	1420	10000	2778	84.5	830	84	70	81
	TRT 100 E 6P	15074	400	1100	2.30	6	950	10800	3000	48	471	77	85	117
	TRT 100 E 8P	15075	400	930	2.10	8	715	11000	3056	34	334	71	80	127
	TRT 150 E 6P	15076	400	1930	3.45	6	930	15000	4167	61	598	80	80	128
	TRT 150 E 8P	15077	400	1600	3.10	8	715	15000	4167	45	441	74	75	132
	TRT 180 E 6P	15078	400	3100	5.95	6	970	16000	4444	79	775	83	80	130
	TRT 210 E 6P	15079	400	3400	6.40	6	980	18000	5000	79	775	84	70	180

* Maximum continuous operating temperature of the product.

NOTE:

The appliance are designed so that they are able to operate at an air temperature more than 60°C.



INDUSTRIAL VENTILATION

TORRETTE TR-E RANGE

DIMENSIONS

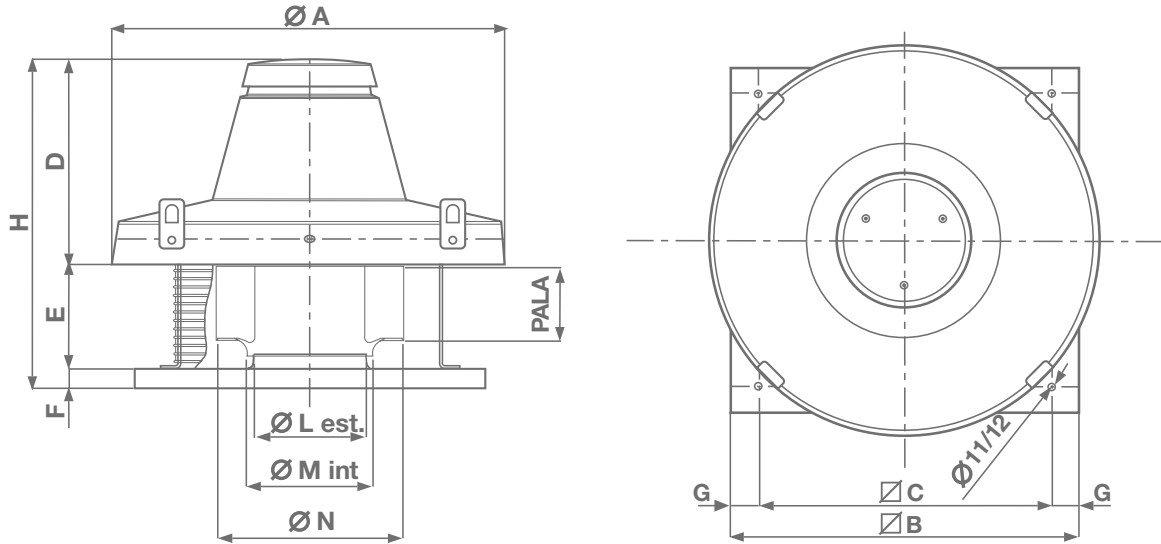

PRODUCTS	IMPELLER	ØA	ØB	ØC	D	E	F	G	H	ØL	ØM	ØN	BLADE
TR 10 E 4P	283x101	600	410	357	310	108	38	26.5	456	170	187.5	283	101
TR 15 E 4P	315x100	600	410	357	310	108	38	26.5	456	182	199	315	100
TR 20 E 4P	395x125	780	550	500	398	128	38	25	554	219	236.5	359	125
TR 30 E 4P	404x140	780	550	500	398	146	38	25	582	244	265.5	404	140
TR 50 E 4P	454x160	780	550	500	398	173	38	25	609	278	298	454	160
TR 70 E 4P	500x160	1015	830	750	449	283	38	40	770	328	335	504	160
TR 70 E 6P	560x180	1015	830	750	449	283	38	40	770	365	375	564	180
TR 100 E 4P	560x180	1015	830	750	449	283	38	40	770	365	375	564	180
TR 100 E 6P	630x224	1165	980	900	605	383	38	40	1026	415	421	635	224
TR 100 E 8P	710x224	1165	980	900	605	383	38	40	1026	465	472	715	224
TR 150 E 6P	710x250	1165	980	900	605	383	38	40	1026	465	472	715	250
TR 150 E 8P	800x250	1165	980	900	605	383	38	40	1026	520	529	805	250
TR 180 E 6P	800x224	1165	980	900	605	383	38	40	1026	520	529	805	224
TR 210 E 6P	800x250	1165	980	900	605	383	38	40	1026	520	529	805	250

Dimensions (mm)



PERFORMANCE CURVES

TRM 10 E 4P

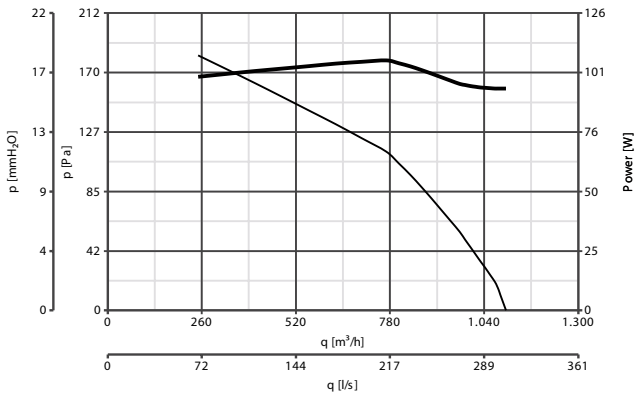

TRM 15 E 4P

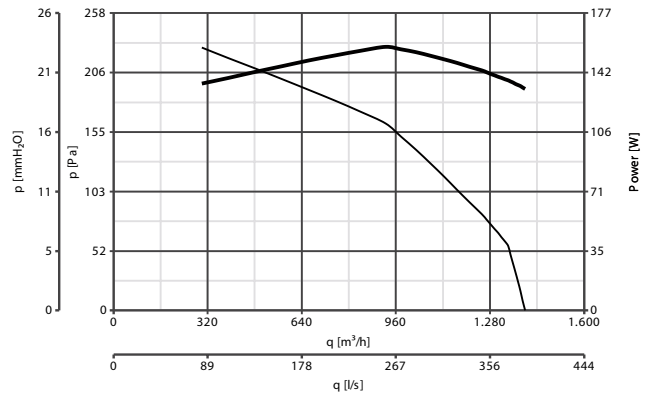

TRM 20 E 4P

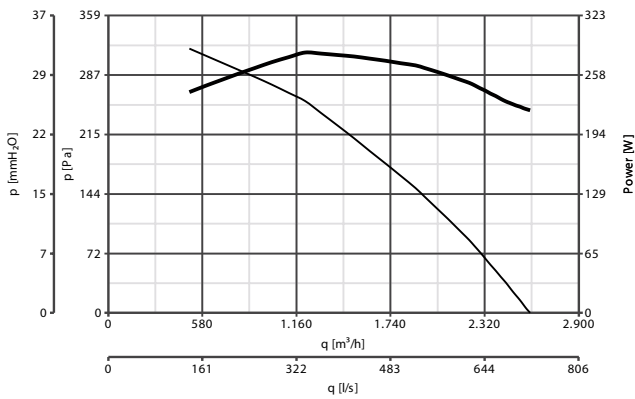

TRM 30 E 4P

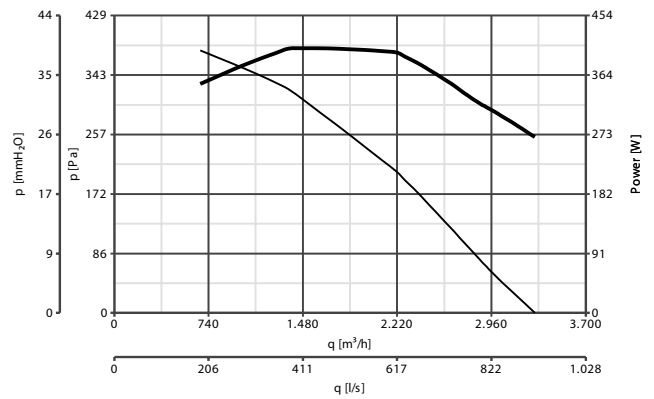

TRM 50 E 4P

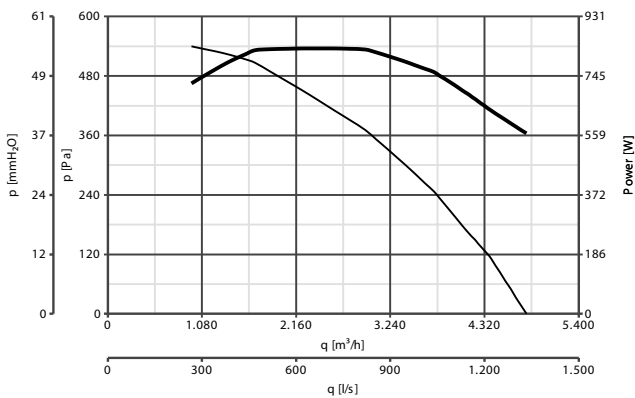

TRM 70 E 4P

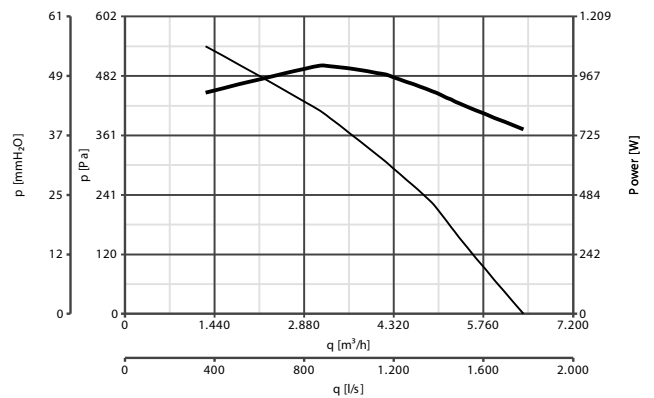

Power consumption
 Delivery



PERFORMANCE CURVES

TRT 10 E 4P

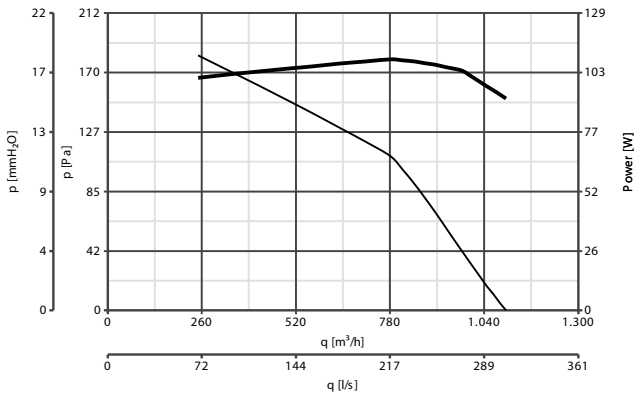

TRT 15 E 4P

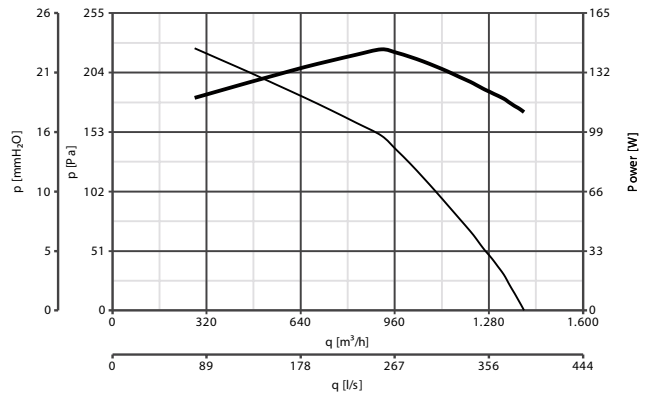

TRT 20 E 4P

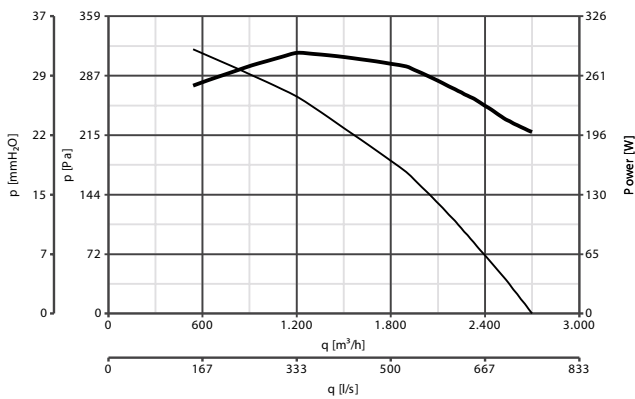

TRT 30 E 4P

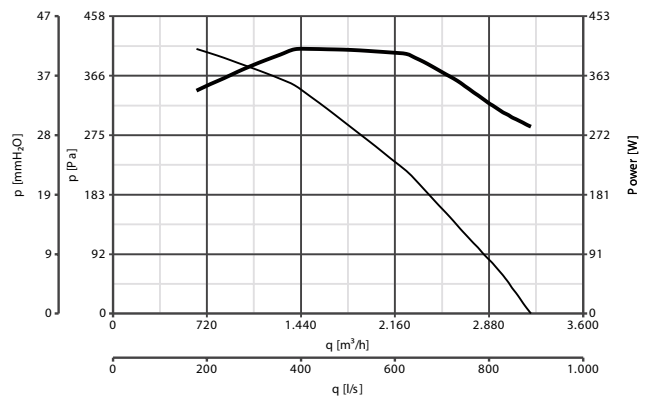

TRT 50 E 4P

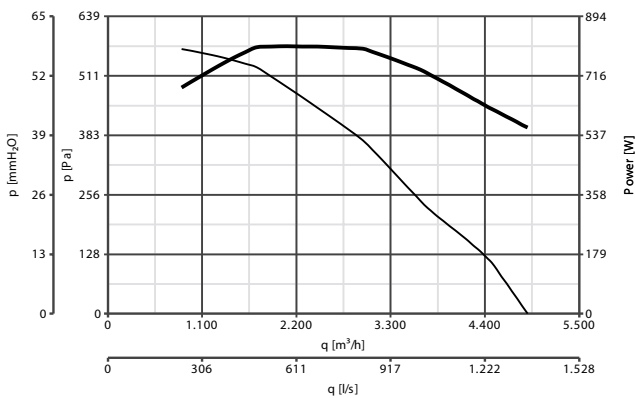

TRT 70 E 4P

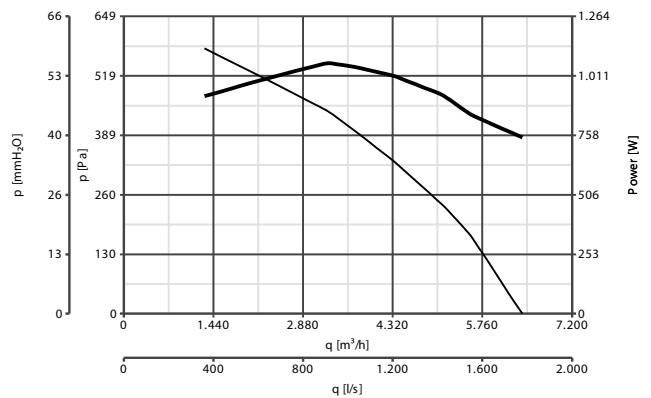

— Power consumption
— Delivery



PERFORMANCE CURVES

TRT 70 E 6P

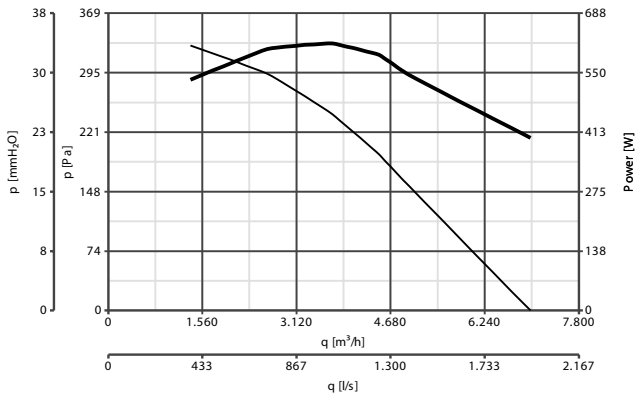

TRT 100 E 4P

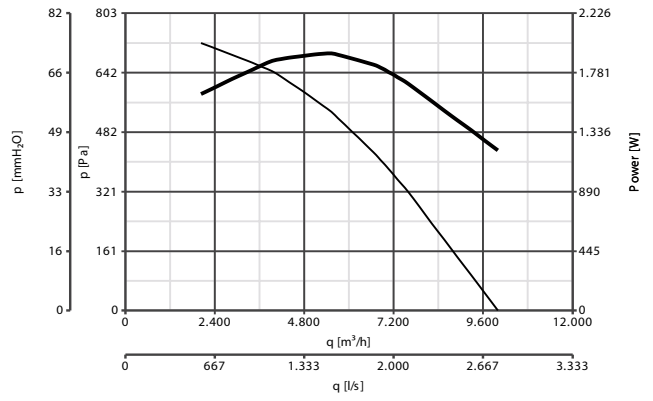

TRT 100 E 6P

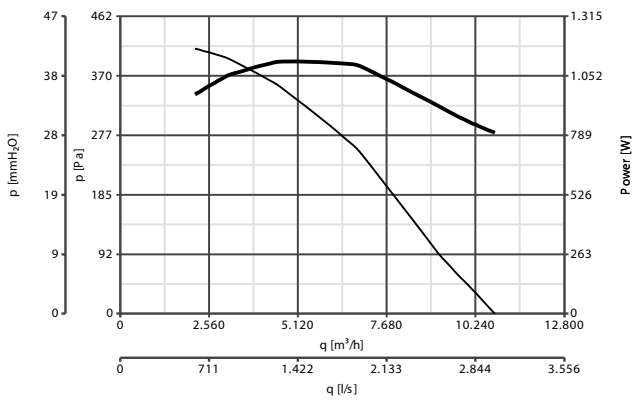

TRT 100 E 8P

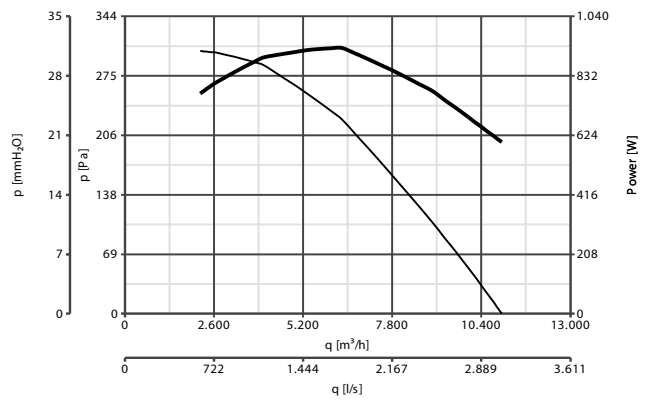

TRT 150 E 6P

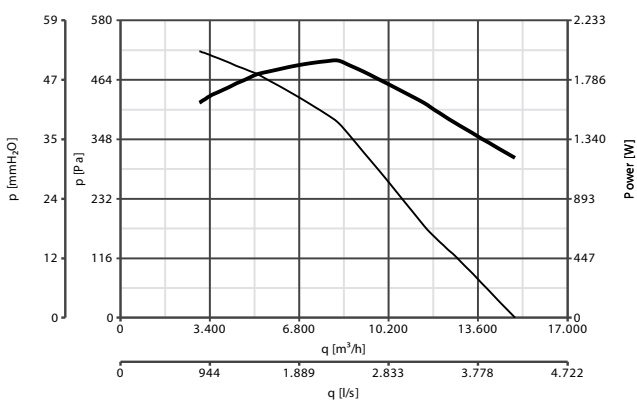

TRT 150 E 8P

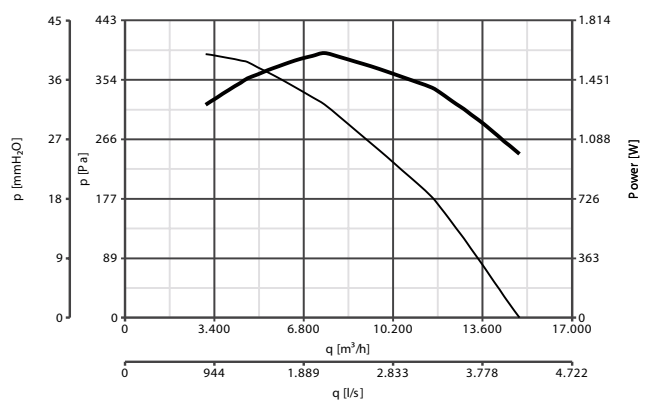

Power consumption
 Delivery





INDUSTRIAL VENTILATION

TORRETTE TR-E RANGE

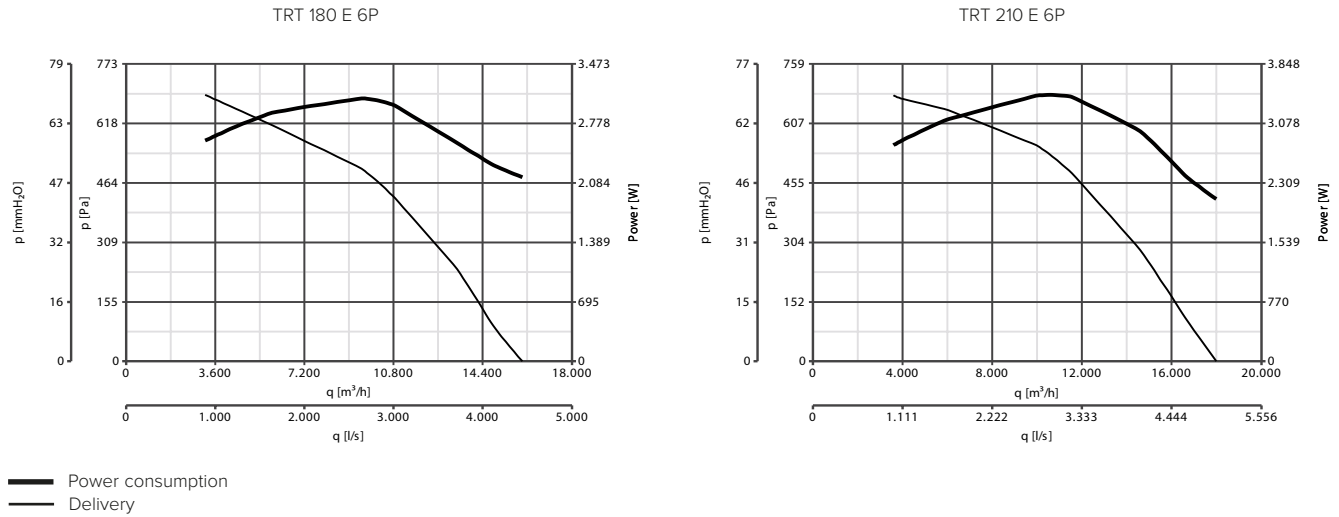
PERFORMANCE CURVES









ACCESSORIES

MODELS	DESCRIPTION	CODE	PRODUCTS
	TR-CU - Sub-frame	10/15	22511 15115 - 15155 - 15205 - 15255
		20/30/50	22512 15215 - 15216 - 15355 - 15356 - 15555 - 15556
		70/100	22539 15070 - 15071 - 15072 - 15073
		100/150/180/210	22540 15074 - 15075 - 15076 - 15077 - 15078 - 15079
	TR-B - Suction connector	10/15	22600 15115 - 15155 - 15205 - 15255
		20/30/50	22610 15215 - 15216 - 15355 - 15356 - 15555 - 15556
		70/100	22508 15070 - 15071 - 15072 - 15073
		100/150/180/210	22509 15074 - 15075 - 15076 - 15077 - 15078 - 15079
	TR-G - Intake port protection grille	10/15	22700 15115 - 15155 - 15205 - 15255
		20/30/50	22710 15215 - 15216 - 15355 - 15356 - 15555 - 15556
		70/100	22506 15070 - 15071 - 15072 - 15073
		100/150/180/210	22507 15074 - 15075 - 15076 - 15077 - 15078 - 15079



CONTROLLERS

MODELS	DESCRIPTION	CODE	PRODUCTS
	IRM 30 - Three position single-phase speed controller	12921	15115 - 15205
	IRM 40 - Three position single-phase speed controller	12922	15216 - 15356
	IRM 50 - Three position single-phase speed controller	12928	15556
	IRT 15 - Three position single-phase speed controller	12923	15155 - 15215 - 15255
	IRT 35 - Three position single-phase speed controller	12924	15072 - 15075 - 15355 - 15555
	IRT 40 - Three position single-phase speed controller	12927	15071 - 15074
	IREM 3 - Single-phase speed controller 3A	12931	15115 - 15205 - 15216 - 15356
	IREM 5 - Single-phase speed controller 5A*	12932	15070 - 15115 - 15205 - 15556
	IRET 6 - Three-phase speed controller 6A	12934	15071 - 15072 - 15074 - 15075 - 15076 - 15077
	C 1.5 - Speed controller 1.5A	12966	15155
	IREM INVERTER 4 M - Single-phase speed controller INVERTER**	12815	15115 - 15205 - 15216 - 15356
	IREM INVERTER 6 M - Single-phase speed controller INVERTER**	12818	15556 - 15070
	IRET INVERTER 2.5 M - Three-phase speed controller INVERTER**	12816	15155 - 15255 - 15215 - 15355 - 15555 - 15071 - 15072 - 15075
	IRET INVERTER 5 M - Three-phase speed controller INVERTER**	12817	15073 - 15074 - 15076 - 15077
	IRET INVERTER 8 M - Three-phase speed controller INVERTER**		15078 - 15079
	POT - Potentiometer	12828	12815 - 12816 - 12817 - 12818
	TR-CVT - Three-phase speed switch	22910	15155 - 15215 - 15255 - 15355 - 15555

* Can control multiple fans up to a maximum 5A

** To adjust a regulator with inverter, combine a 0-10V potentiometer as code 12828



TORRETTE TR-E-V RANGE

Centrifugal roof fans with vertical discharge

Roof-mounted centrifugal fans with vertical discharge, for installation in the proximity of apertures and/or air vents. Available in different diameters and in single and three-phase versions, designed for the ventilation of civil and industrial environments such as gyms, restaurants, offices, theatres, discos, hospitals and factories.

Key features

- Possibility of installation in the proximity of apertures or air vents.
- Robust and weatherproof construction.
- Designed to operate in high environmental temperatures ($\geq 70^{\circ}\text{C}$), in compliance with typical application requirements for hot climates.
- Wide range of performance.

Versions

20 models, in single and three phase version, with 4, 6 and 8 poles.

Technical features

- Bases made of pickled and phosphated steel sheet, grey epoxy powder-coated with hammered finish.
- Motor cover made of pickled and phosphated steel sheet, polyester powder-coated and furnace-baked.
- Guaranteeing higher long-term resistance to aggressive agents over time, in grey colour with hammered finish.
- Lateral bulkheads for vertical discharge of the air handled made of galvanised steel sheet, grey polyester powder-coated and furnace-baked, guaranteeing higher long-term resistance to aggressive agents and with hammered finish.
- Ventilation ports, fashioned in one piece with the body, characterized by aerodynamic profiles, calibrated to optimize the extracted airflow.
- Safety and anti-bird protective grilles designed in accordance with the UNI ISO 13857 standard, made of electrically welded steel rings with epoxy black paint finish.
- Galvanised steel sheet cover plates, designed to divert the flow of air handled, preventing it from striking the drive unit directly and thus protecting it from excessive heat loads.
- Class F or H thermally protected single or three-phase asynchronous motors, depending on the model, with shafts turning on ball bearings with double sealing screen, characterized by high (IP55) degree of protection against dust and water and with cooling fans for more effective heat dissipation.
- Starting capacitors of the single-phase models comply with the EN 60252-1 standard and are third-party certified.
- Centrifugal impellers with electrically galvanised aluminium or steel sheet, depending on the model, self-cleaning, backward-curved blades, dynamically balanced (UNI ISO 1940, Class 6.3), fitted on grooved hubs in die-cast aluminium.
- Wiring boxes complete with moulded cable glands in thermoplastic resin.
- Steel eye-bolts for lifting and transport, protected from corrosion by galvanic treatment.
- Steel cables for secure anchoring of the product to the destination surfaces supplied as standard.

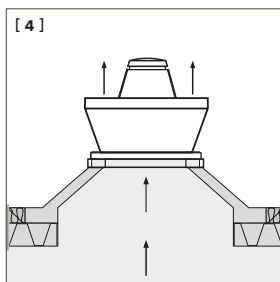
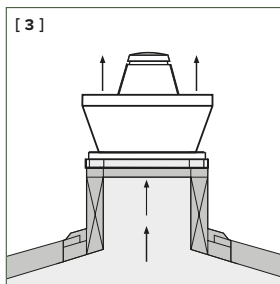
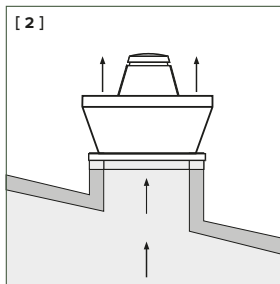
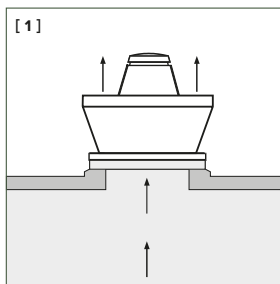

[1] [2] [3] [4] These devices are easily installed on top of each roof. The air must not be dusty, acidic or corrosive.

Note

- The fans mounted in the torrette TR-E-V range towers comply with Reg. ErP No. 327/2011/UE.
- The fans of the torrette TR-E-V range towers comply with Reg. ErP No. 1253/2014/UE.
- The towers of the torrette TR-E-V range are not suitable for handling flows characterized by significant concentrations of abrasive dust or acid or corrosive substances.



TECHNICAL DATA

	PRODUCTS	CODE	V~50HZ	W	A	POLES	RPM	MAX AIRFLOW		MAX PRESSURE		Lp dB(A) 3 m	MAX °C*	KG
								m³/h	l/s	mmH ₂ O	Pa			
SINGLE-PHASE	TRM 10 E-V 4P	15180	230	100	0.50	4	1400	1100	306	22	216	56	90	23
	TRM 15 E-V 4P	15182	230	150	0.70	4	1400	1440	389	26	255	58.5	80	24
	TRM 20 E-V 4P	15197	230	280	1.30	4	1415	2600	722	36	353	62	85	43
	TRM 30 E-V 4P	15198	230	400	1.80	4	1425	3300	917	44	432	67	70	45
	TRM 50 E-V 4P	15199	230	800	3.70	4	1480	4800	1333	55	540	72.5	80	51
	TRM 70 E-V 4P	15188	230	1000	4.35	4	1415	6400	1778	67.5	662	77	90	105
	TRT 10 E-V 4P	15181	400	100	0.30	4	1400	1100	306	22	216	56	90	23
TRT 15 E-V 4P	15183	400	150	0.30	4	1400	1400	389	26	255	58.5	90	24	
TRT 20 E-V 4P	15184	400	300	0.60	4	1400	2700	750	35	343	62	90	43	
TRT 30 E-V 4P	15185	400	400	0.75	4	1400	3200	889	46	451	67	90	45	
TRT 50 E-V 4P	15186	400	800	1.45	4	1400	4900	1361	61	598	72.5	90	51	
TRT 70 E-V 4P	15187	400	950	1.85	4	1440	6400	1778	69	674	77	90	103	
THREE-PHASE	TRT 70 E-V 6P	15189	400	600	1.30	6	950	7000	1944	38	373	74	90	106
	TRT 100 E-V 4P	15190	400	1900	3.25	4	1420	10000	2778	84.5	830	84	70	107
	TRT 100 E-V 6P	15191	400	1100	2.30	6	950	10800	3000	48	471	77	85	161
	TRT 100 E-V 8P	15192	400	930	2.10	8	715	11000	3056	34	334	71	80	171
	TRT 150 E-V 6P	15193	400	1930	3.45	6	930	15000	4167	61	598	80	80	172
	TRT 150 E-V 8P	15194	400	1600	3.10	8	715	15000	4167	45	441	74	75	176
	TRT 180 E-V 6P	15195	400	3100	5.95	6	970	16000	4444	79	775	83	80	174
TRT 210 E-V 6P	15196	400	3400	6.40	6	980	18000	5000	79	775	84	70	180	

* Maximum continuous operating temperature of the product.

NOTE:

The appliance are designed so that they are able to operate at an air temperature more than 60°C.



INDUSTRIAL VENTILATION

TORRETTE TR-E-V RANGE

DIMENSIONS

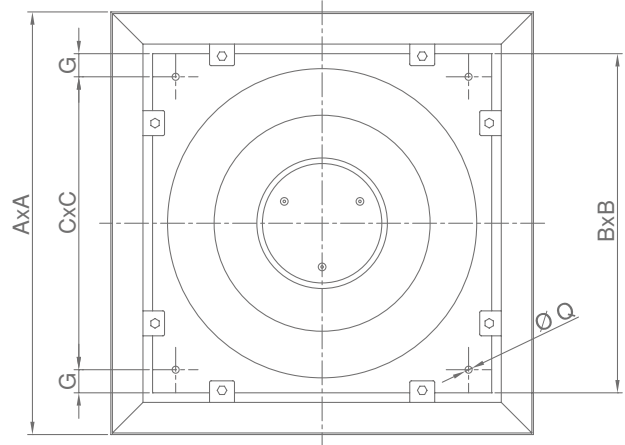
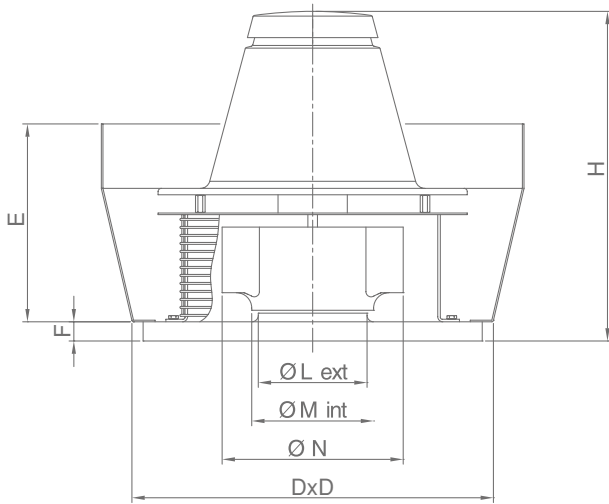

PRODUCTS	IMPELLERS	∅A	∅B	∅C	∅D	E	F	G	H	∅L	∅M	∅N	∅Q
TR 10 E-V 4P	283x101	652	410	357	440	328	38	26.5	502	170	187.5	283	11
TR 15 E-V 4P	315x100	652	410	357	440	328	38	26.5	502	182	199	315	11
TR 20 E-V 4P	395x125	907	550	500	580	432	38	25	586	219	236.5	359	11
TR 30 E-V 4P	404x140	907	550	500	580	432	38	25	604	244	265.5	404	11
TR 50 E-V 4P	454x160	907	550	500	580	432	38	25	631	278	298	454	11
TR 70 E-V 4P	500x160	1144	830	750	860	491	38	40	723	328	335	504	12
TR 70 E-V 6P	560x180	1144	830	750	860	491	38	40	723	365	375	564	12
TR 100 E-V 4P	560x180	1144	830	750	860	491	38	40	723	365	375	564	12
TR 100 E-V 6P	630x224	1462	980	900	1010	595	38	40	903	415	421	635	12
TR 100 E-V 8P	710x224	1462	980	900	1010	595	38	40	903	465	472	715	12
TR 150 E-V 6P	710x250	1462	980	900	1010	595	38	40	903	465	472	715	12
TR 150 E-V 8P	800x250	1462	980	900	1010	595	38	40	903	520	529	805	12
TR 180 E-V 6P	800x224	1462	980	900	1010	595	38	40	903	520	529	805	12
TR 210 E-V 6P	800x250	1462	980	900	1010	595	38	40	903	520	529	805	12

Dimensions (mm)



PERFORMANCE CURVES

TRM 10 E-V 4P

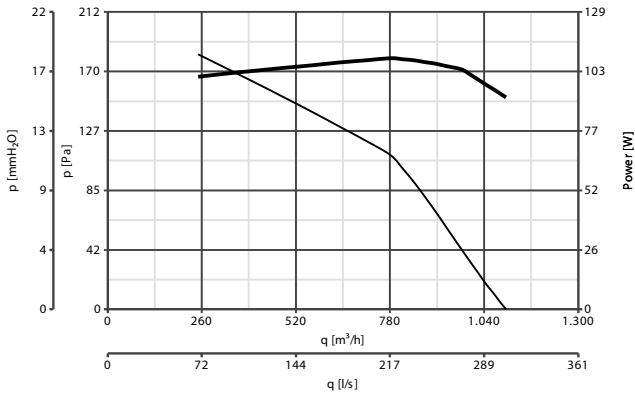

TRM 15 E-V 4P

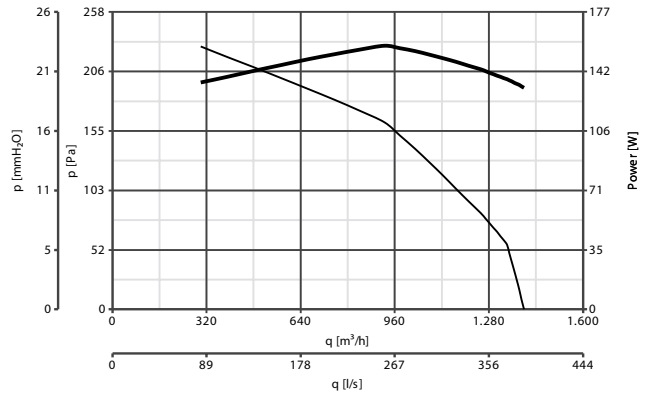

TRM 20 E-V 4P

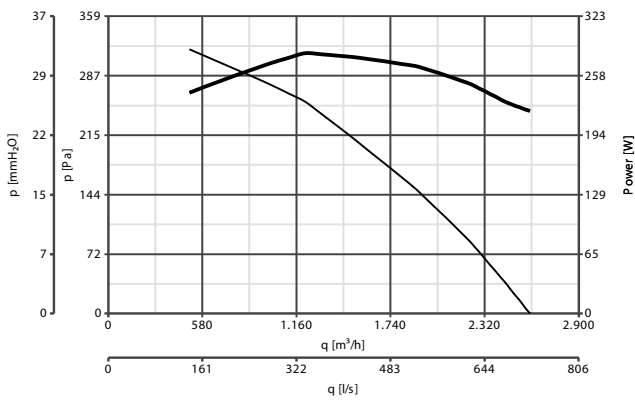

TRM 30 E-V 4P

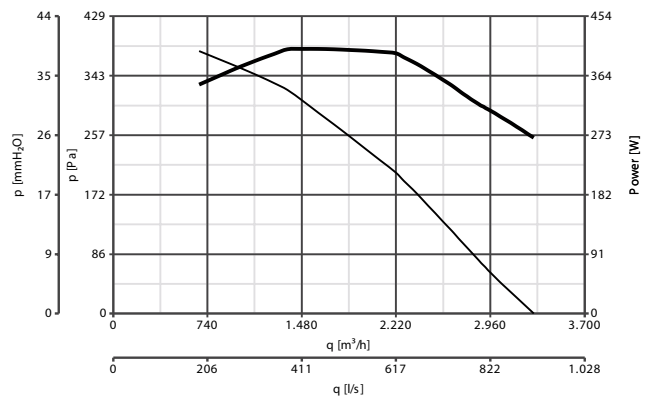

TRM 50 E-V 4P

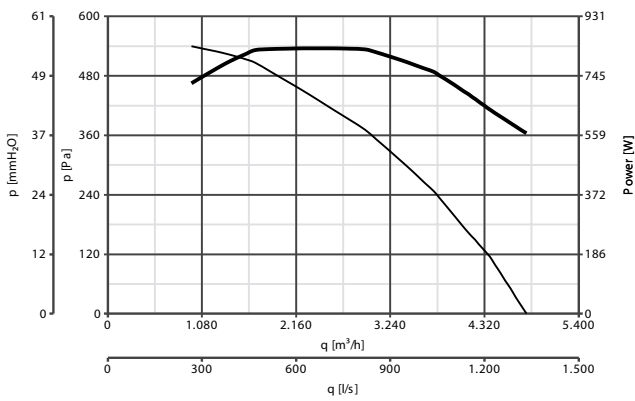

TRM 70 E-V 4P

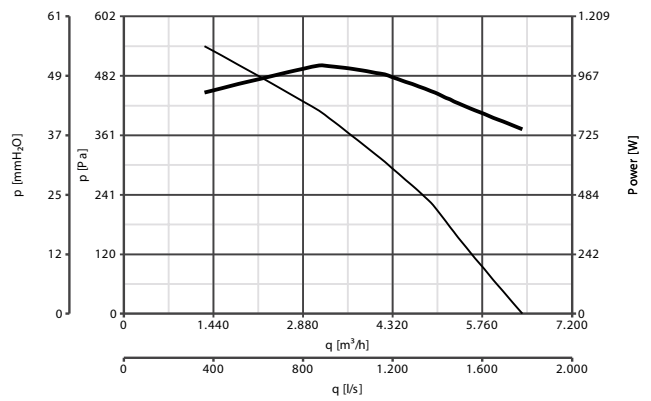

— Power consumption
— Delivery



PERFORMANCE CURVES

TRT 10 E-V 4P

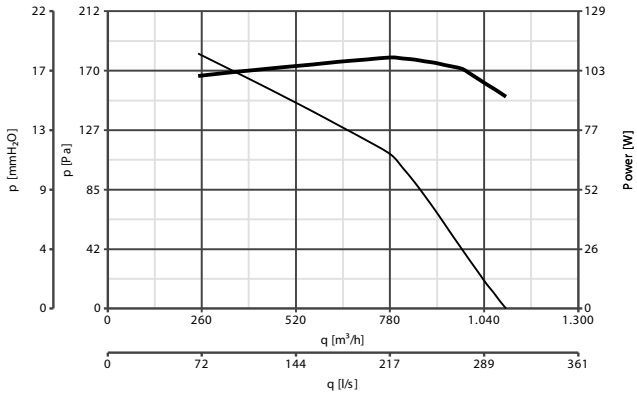

TRT 15 E-V 4P

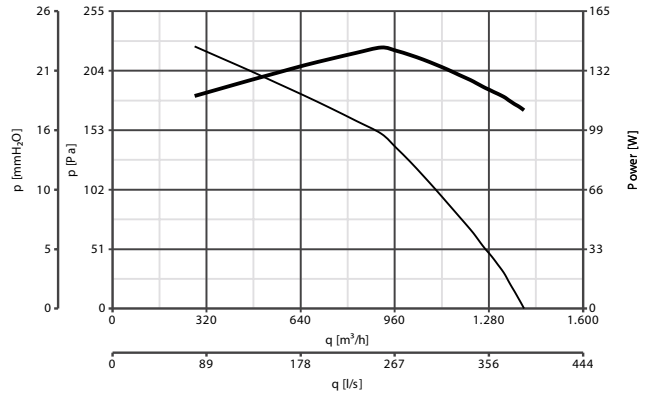

TRT 20 E-V 4P

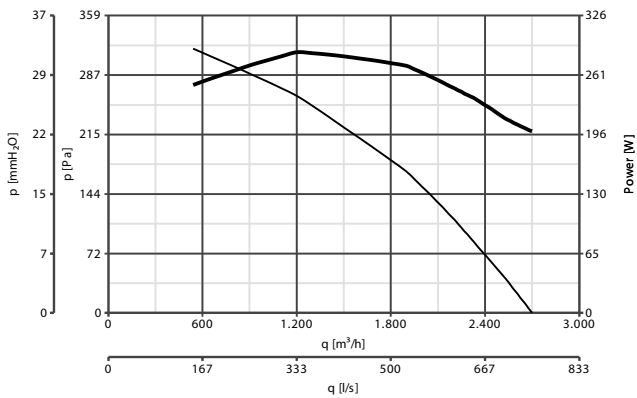

TRT 30 E-V 4P

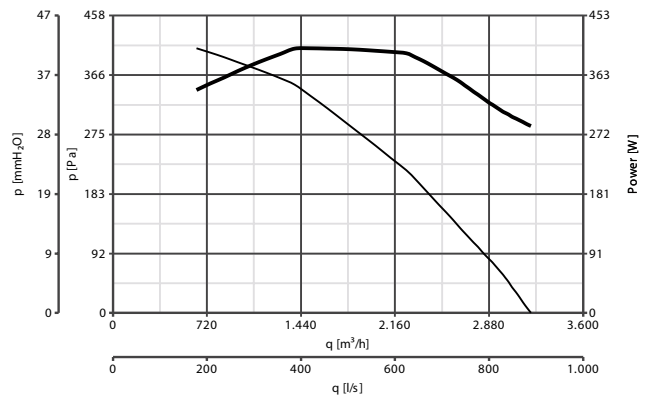

TRT 50 E-V 4P

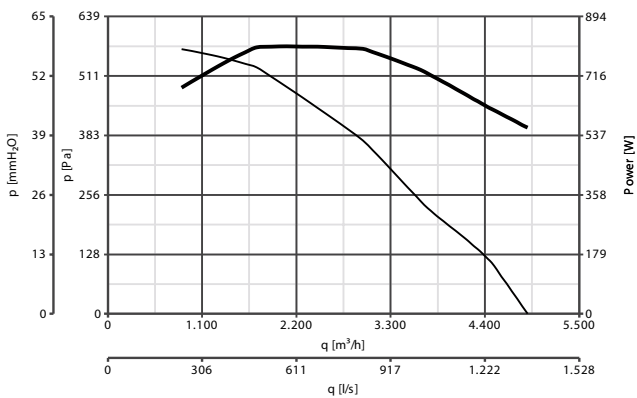

TRT 70 E-V 4P

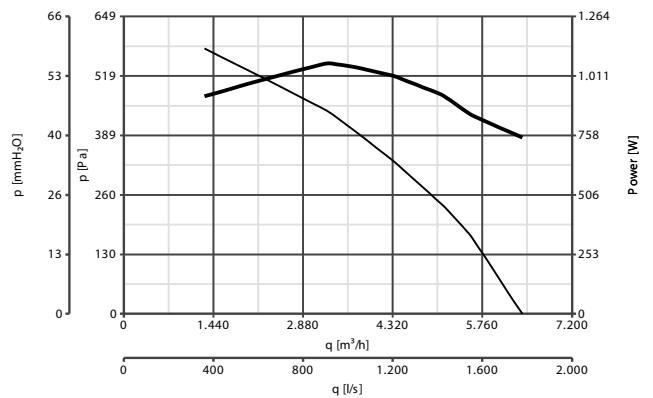

— Power consumption
— Delivery



PERFORMANCE CURVES

TRT 70 E-V 6P

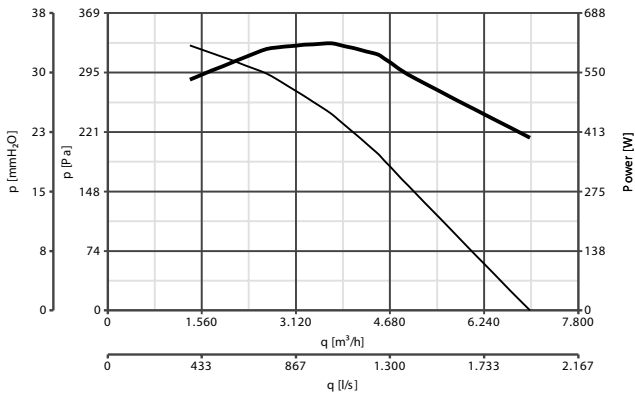

TRT 100 E-V 4P

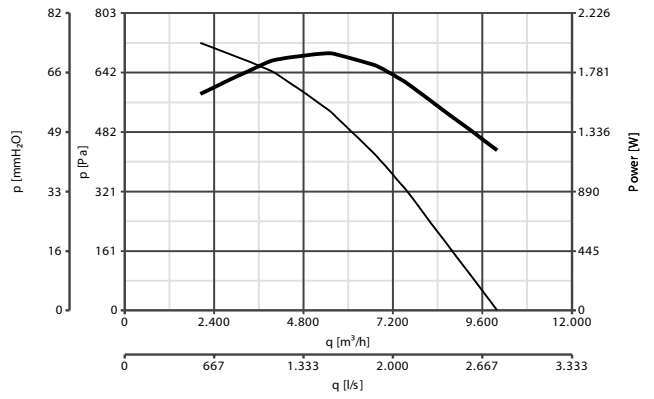

TRT 100 E-V 6P

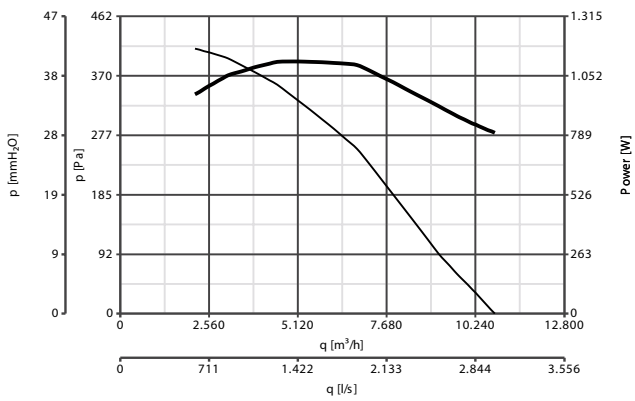

TRT 100 E-V 8P

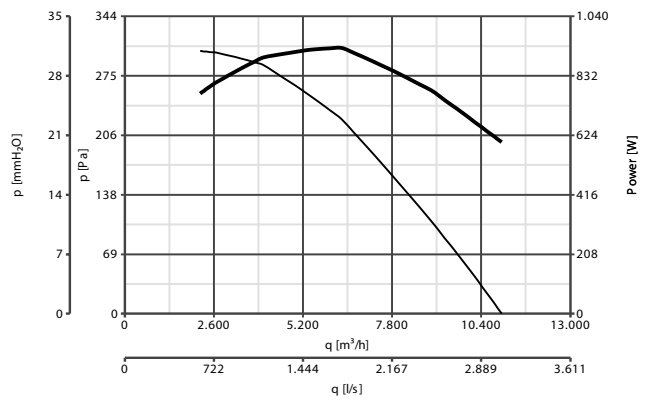

TRT 150 E-V 6P

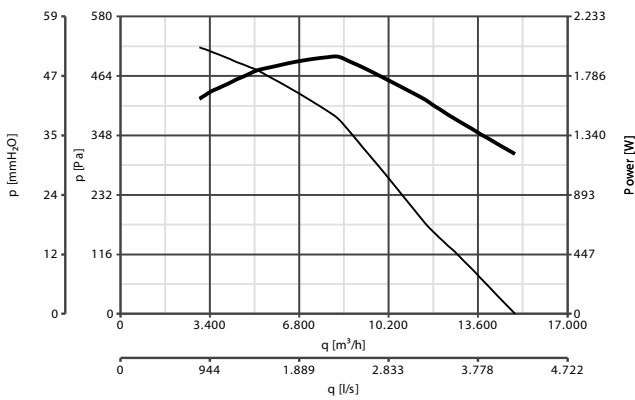

TRT 150 E-V 8P

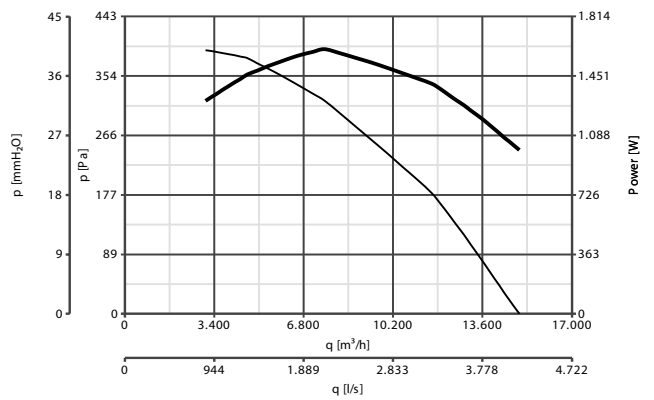

— Power consumption
— Delivery

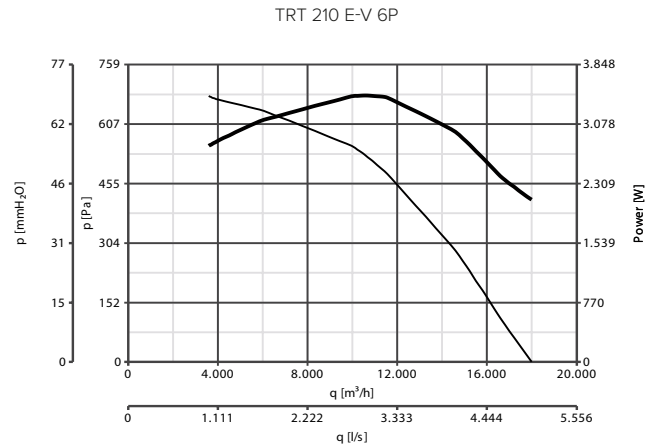
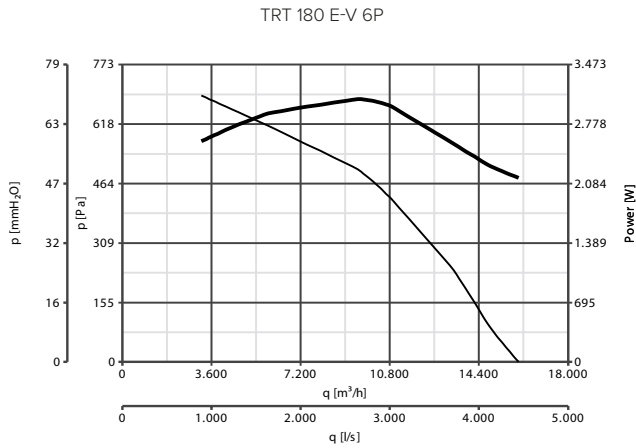



PERFORMANCE CURVES

— Power consumption
— Delivery

ACCESSORIES

MODELS	DESCRIPTION	CODE	PRODUCTS
	TR-CU - Controtelaio di base	10/15	22511 15180 - 15181 - 15182 - 15183
		20/30/50	22512 15184 - 15185 - 15186 - 15197 - 15198 - 15199
		70/100	22539 15187 - 15188 - 15189 - 15190
		100/150/180/210	22540 15191 - 15192 - 15193 - 15194 - 15195 - 15196
	TR-S - Serranda di non ritorno	10/15	22500 15180 - 15181 - 15182 - 15183
		20/30/50	22510 15184 - 15185 - 15186 - 15197 - 15198 - 15199
		70/100	22541 15187 - 15188 - 15189 - 15190
		100/150/180/210	22542 15191 - 15192 - 15193 - 15194 - 15195 - 15196
	TR-B - Boccaglio di aspirazione	10/15	22600 15180 - 15181 - 15182 - 15183
		20/30/50	22610 15184 - 15185 - 15186 - 15197 - 15198 - 15199
		70/100	22508 15187 - 15188 - 15189 - 15190
		100/150/180/210	22509 15191 - 15192 - 15193 - 15194 - 15195 - 15196
	TR-G - Griglia di protezione	10/15	22700 15180 - 15181 - 15182 - 15183
		20/30/50	22710 15184 - 15185 - 15186 - 15197 - 15198 - 15199
		70/100	22506 15187 - 15188 - 15189 - 15190
		100/150/180/210	22507 15191 - 15192 - 15193 - 15194 - 15195 - 15196

CONTROLLERS

MODELS	DESCRIPTION	CODE	PRODUCTS
	IRM 30 - Three position single-phase speed controller	12921	15180 - 15182
	IRM 40 - Three position single-phase speed controller	12922	15197 - 15198
	IRM 50 - Three position single-phase speed controller	12928	15199
	IRT 15 - Three position single-phase speed controller	12923	15181 - 15183 - 15184
	IRT 35 - Three position single-phase speed controller	12924	15185 - 15186 - 15189 - 15192
	IRT 40 - Three position single-phase speed controller	12927	15187 - 15190 - 15191 - 15193 - 15194
	IREM 3 - Single-phase speed controller 3A	12931	15180 - 15182 - 15197 - 15198
	IREM 5 - Single-phase speed controller 5A*	12932	15180 - 15182 - 15188 - 15199
	IRET 6 - Three-phase speed controller 6A	12934	15187 - 15189 - 15190 - 15191 - 15192 - 15193 - 15194
	IREM INVERTER 4 M - Single-phase speed controller INVERTER	12815	15180 - 15182 - 15197 - 15198
	IREM INVERTER 6 M - Single-phase speed controller INVERTER	12818	15199 - 15188
	IRET INVERTER 2.5 M - Three-phase speed controller INVERTER	12816	15181 - 15183 - 15184 - 15185 - 15186 - 15187 - 15189 - 15192
	IRET INVERTER 5 M - Three-phase speed controller INVERTER	12817	15190 - 15191 - 15193 - 15194
	POT - Potentiometer	12828	12815 - 12816 - 12817 - 12818

* Can control multiple fans up to a maximum 5A

** To adjust a regulator with inverter, combine a 0-10V potentiometer as code 12828



TORRETTE TR-ED RANGE

Centrifugal roof fans with horizontal discharge for hot fumes extraction



Roof-mounted centrifugal fans with radial discharge, designed and certified for hot fume extraction (F400/120), available in different diameters and in single and three-phase versions. In the event of fires, they guarantee safety in civil and industrial environments such as condominiums, gyms, restaurants, offices, theatres, discos, hospitals and factories.

Key features

- Full compliance with the EN 12101-3 standard (TUV or APPLUS certification), depending on the model, class F400/120.
- Robust and weatherproof construction.
- Easy installation on a wide range of roof types.

Versions

20 models, in single and three-phase version, with 4, 6 and 8 poles.

Technical features

- Bases made of pickled and phosphated steel sheet, grey epoxy powder-coated with hammered finish.
- Motor cover made of pickled and phosphated steel sheet, polyester powder-coated and furnace-baked, guaranteeing higher long-term resistance to aggressive agents, in grey colour with hammered finish.
- Ventilation ports, fashioned in one piece with the body, characterized by aerodynamic profiles, calibrated to optimize the extracted airflow.
- Safety and anti-bird protective grilles designed in accordance with the UNI ISO 13857 standard, made of electrically welded steel rings with epoxy black paint finish.
- Galvanised steel sheet motor cover plates, designed to divert the flow of air handled, preventing it from striking the drive unit directly and thus protecting it from excessive heat loads.
- Class H single or three-phase asynchronous motors, depending on the model, with shafts turning on ball bearings with double sealing screen, characterized by high (IP55) degree of protection against dust and water and with cooling fans for more effective heat dissipation.
- Starting capacitors of the single-phase models comply with the EN 60252-1 standard and are third-party certified.
- Centrifugal impeller with electrically galvanised steel sheet, self-cleaning, backward-curved blades, dynamically balanced (UNI ISO 1940, Class 6.3), fitted on grooved hubs in die-cast aluminium.
- Metal cable gland for connection to the mains, guaranteeing adequate resistance to high temperatures.
- Steel eye-bolts for lifting and transport, protected from corrosion by galvanic treatment.
- Steel cables for secure anchoring of the product to the destination surfaces supplied as standard.

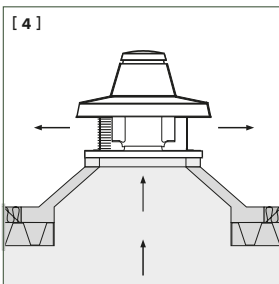
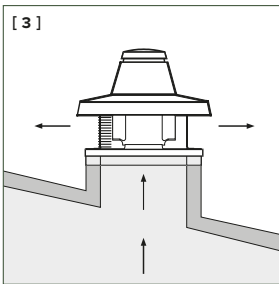
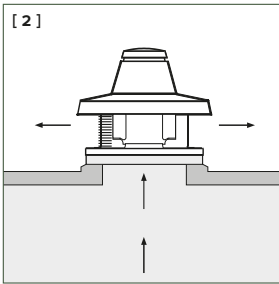

[1] [2] [3] [4] Robust construction. These devices are easily installed on top of each roof. The air must not be dusty, acidic or corrosive. Not suitable for installation in ducts placed directly over chimneys or burners.

Note

- In European Community countries and in those that have implemented Reg. ErP No. 327/2011, the towers of the torrette TR ED range can only be used as safety equipment operating at maximum speed for the evacuation of hot fumes (class F400/120).
- In countries that are not part of the European Community or in those that have not implemented Reg. Erp No. 327/2011, the towers of the torrette TR ED range can be for uses other than the evacuation of hot fumes in the case of fire; as such, their speed is adjustable by Vortice controllers. For these uses, the continuous operating environmental temperature is between -25°C and + 90°C.
- The towers of the torrette TR ED range are not suitable for handling flows characterized by significant concentrations of abrasive dust or acid or corrosive substances.
- The towers of the torrette TR ED range are not suitable for installation at the end of ducts positioned directly above fireplaces or burners.





INDUSTRIAL VENTILATION

TORRETTE TR-ED RANGE

TECHNICAL DATA

	PRODUCTS	CODE	V~50HZ	W	A	POLES	RPM	MAX AIRFLOW		MAX PRESSURE		Lp dB(A) 3 m	MAX °C*	KG
								m³/h	l/s	mmH ₂ O	Pa			
SINGLE-PHASE	TRM 10 ED 4P	15039	220-240	110	0.46	4	1395	1000	278	20	196	56	400 °C/2H	18.5
	TRM 15 ED 4P	15041	220-240	140	0.60	4	1315	1400	389	24	235	58.5	400 °C/2H	19
	TRM 20 ED 4P	15043	220-240	280	1.30	4	1375	2200	611	34	334	62	400 °C/2H	33
	TRM 30 ED 4P	15046	220-240	400	1.80	4	1285	3100	861	40	392	67	400 °C/2H	35
	TRM 50 ED 4P	15048	220-240	800	3.70	4	1290	4500	1250	52	510	72.5	400 °C/2H	40
	TRM 70 ED 4P	15080	220-240	1000	4.35	4	1415	5800	1611	65	638	77	400 °C/2H	80
	TRT 10 ED 4P	15040	380-415	72 100	0.13 0.24	4	1270 1430	890 1100	247 306	17 21	167 206	56	400 °C/2H	18.5
TRT 15 ED 4P	15042	380-415	93 130	0.16 0.27	4	1150 1400	1100 1400	306 389	16 24	157 235	58.5	400 °C/2H	19	
TRT 20 ED 4P	15045	380-415	208 270	0.32 0.53	4	1050 1400	1800 2200	500 611	24 34	235 334	62	400 °C/2H	33	
TRT 30 ED 4P	15047	380-415	305 420	0.48 0.75	4	1070 1400	2555 3100	710 861	30 43	294 422	67	400 °C/2H	35	
TRT 50 ED 4P	15049	380-415	530 690	0.80 1.20	4	1150 1400	3800 4500	1056 1250	38 52	373 510	72.5	400 °C/2H	40	
TRT 70 ED 4P	15081	380-415	820 1090	1.50 2.00	4	1150 1400	5300 6000	1472 1667	52 67	510 657	77	400 °C/2H	78	
TRT 70 ED 6P	15082	380-415	420 580	0.80 1.30	6	750 950	5300 6000	1472 1667	30 38	294 373	74	400 °C/2H	81	
TRT 100 ED 4P	15083	380-415	1400 1950	2.30 4.90	4	1200 1400	8300 9100	2306 2528	72 84	706 824	84	400 °C/2H	81.5	
TRT 100 ED 6P	15084	380-415	900 1130	1.40 2.40	6	730 950	7550 8600	2097 2389	38 47	373 461	77	400 °C/2H	114	
TRT 100 ED 8P	15085	380-415	600 860	1.20 2.00	8	570 715	8200 9200	2278 2556	28 34	275 334	71	400 °C/2H	124	
TRT 150 ED 6P	15086	380-415	1280 1930	2.40 3.50	6	700 930	11000 12800	3056 3556	42 59	412 579	80	400 °C/2H	125	
TRT 150 ED 8P	15087	380-415	1000 1500	2.00 3.00	8	610 715	11600 13500	3222 3750	34 42	334 412	74	400 °C/2H	129	
TRT 180 ED 6P	15919	380-415	3200	6.11	6	950	16500	4583	79	775	83	400 °C/2H	127	
TRT 210 ED 6P	15920	380-415	3460	6.42	6	950	18000	5000	80	785	84	400 °C/2H	129	

* Maximum continuous operating temperature of the product



DIMENSIONS

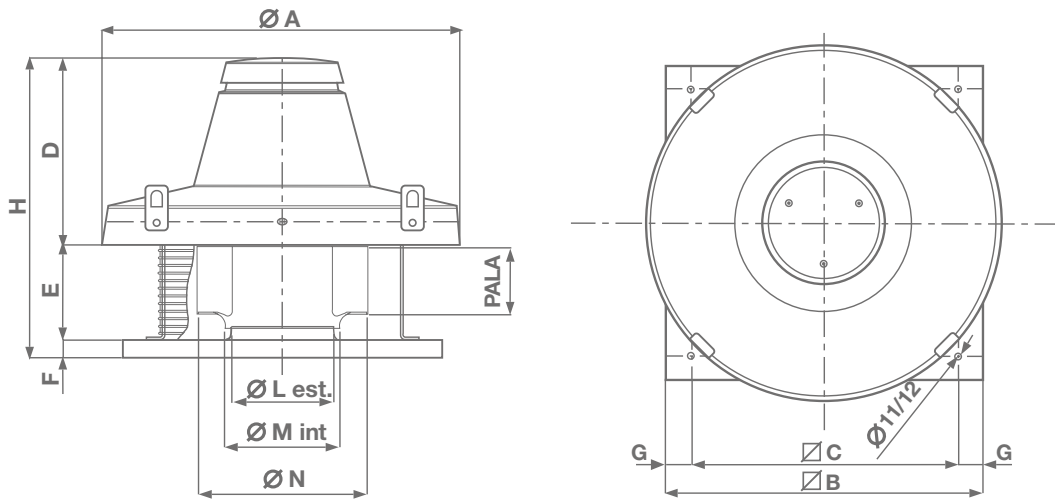

PRODUCTS	IMPELLER	ØA	ØB	ØC	D	E	F	G	H	ØL	ØM	ØN	BLADE
TR 10 ED 4P	280x101.5	600	410	357	309	166	38	26.5	513	183	187.5	284	101.5
TR 15 ED 4P	315x101.5	600	410	500	309	166	38	26.5	513	206	211	319	101.5
TR 20 ED 4P	355x125	780	550	500	397	226	38	25	661	231	236.5	359	125
TR 30 ED 4P	400x140	780	550	500	397	226	38	25	661	260	265.5	404	140
TR 50 ED 4P	450x160	780	550	750	397	243	38	40	678	292	298	454	160
TR 70 ED 4P	500x160	1015	830	750	449	283	38	40	770	328	335	504	160
TR 70 ED 6P	560x180	1015	830	750	449	283	38	40	770	365	375	562	180
TR 100 ED 4P	560x180	1015	830	900	449	283	38	40	770	365	375	562	180
TR 100 ED 6P	630x224	1165	980	900	605	383	38	40	1026	415	421	635	224
TR 100 ED 8P	710x224	1165	980	900	605	383	38	40	1026	465	472	715	224
TR 150 ED 6P	710x250	1165	980	900	605	383	38	40	1026	465	472	715	250
TR 150 ED 8P	800x250	1165	980	900	605	383	38	40	1026	520	529	805	250
TR 180 ED 6P	800x224	1165	980	900	605	383	38	40	1026	520	529	805	224
TR 210 ED 6P	800x250	1165	980	900	605	383	38	40	1026	520	529	805	250

Dimensions (mm)



PERFORMANCE CURVES

TRM 10 ED 4P

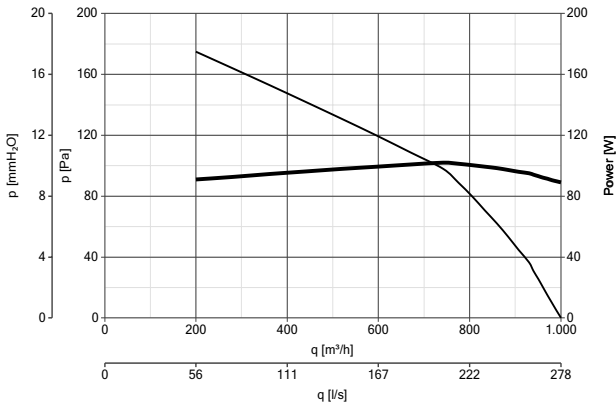

TRM 15 ED 4P

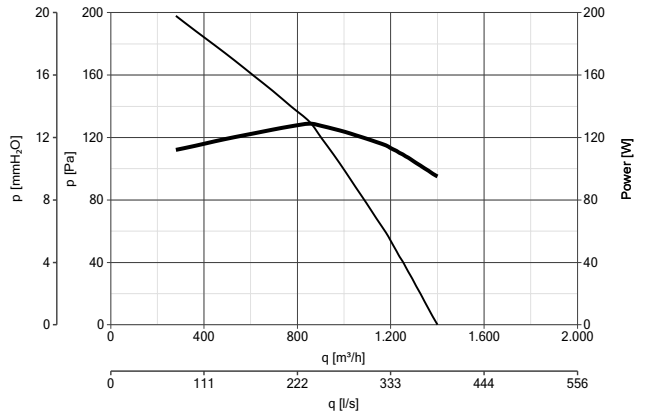

TRM 20 ED 4P

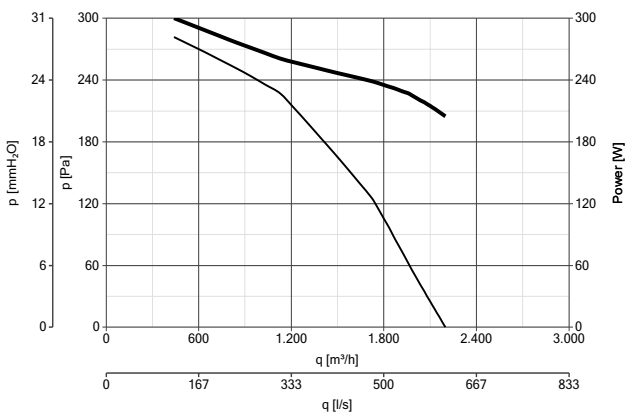

TRM 30 ED 4P

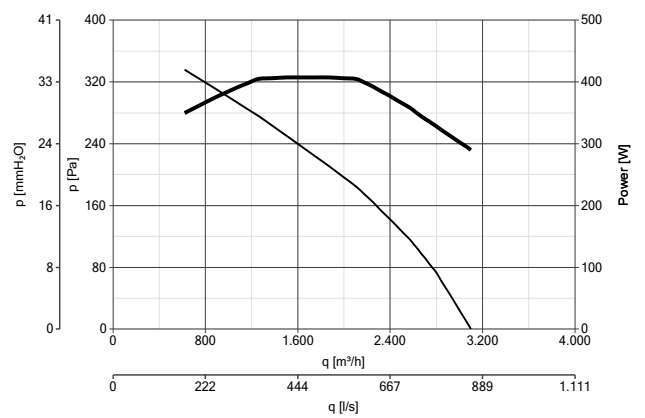

TRM 50 ED 4P

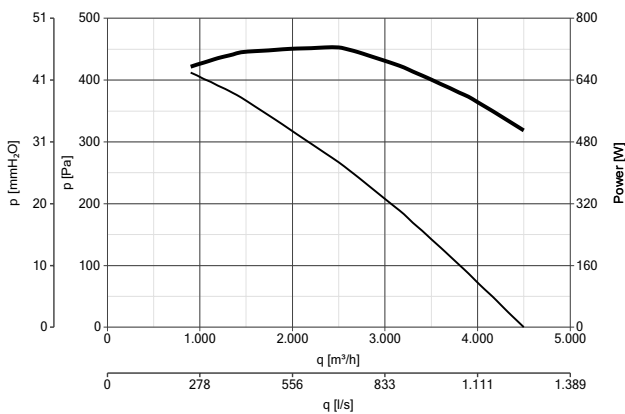

TRM 70 ED 4P

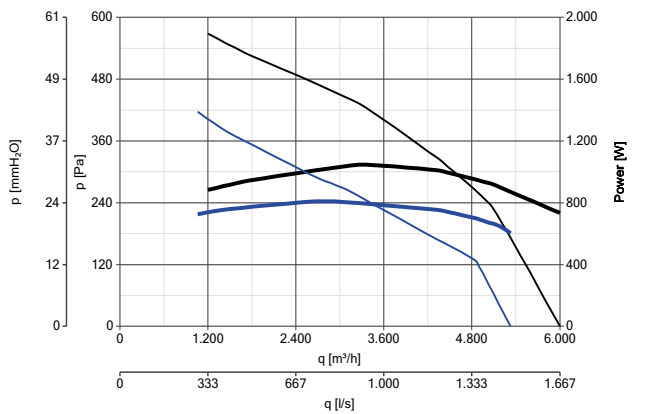

Power consumption
 Delivery



PERFORMANCE CURVES

TRT 10 ED 4P

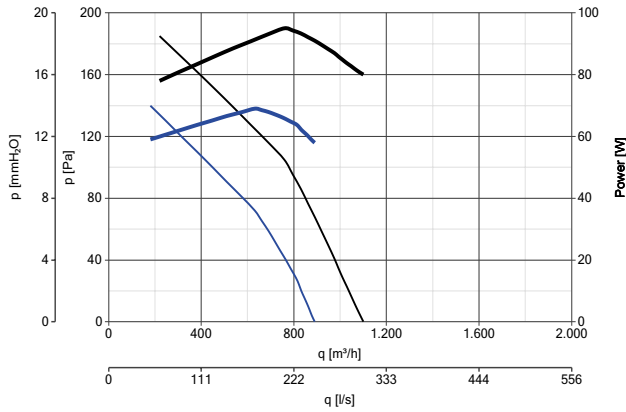

TRT 15 ED 4P

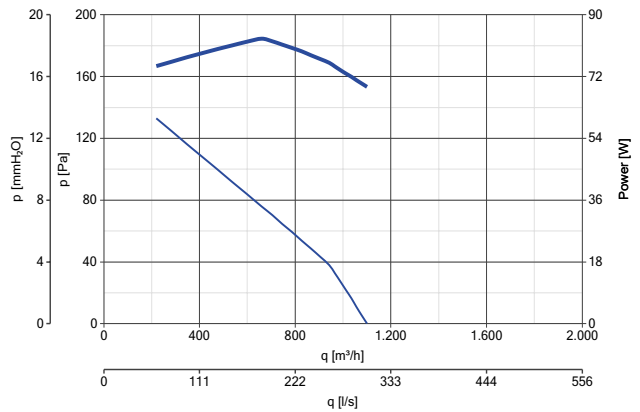

TRT 20 ED 4P

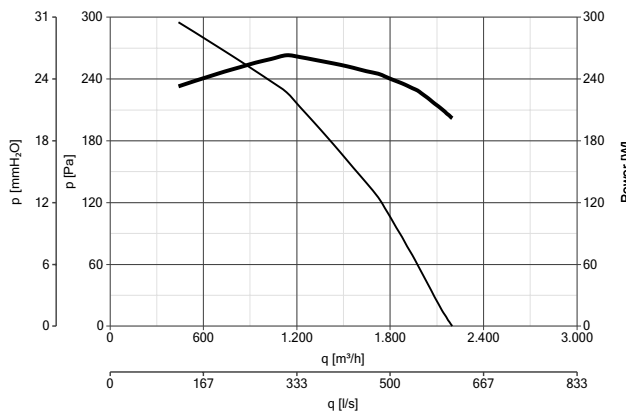

TRT 30 ED 4P

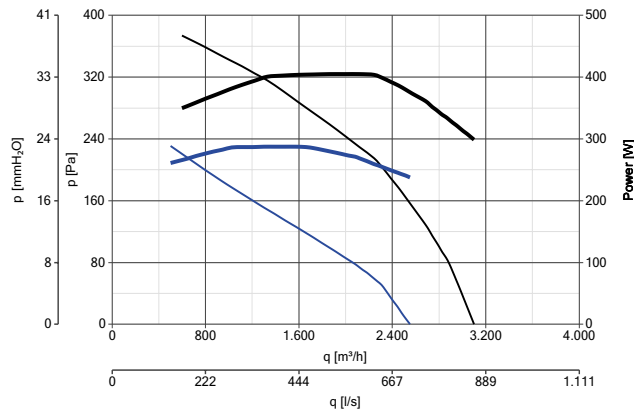

TRT 50 ED 4P

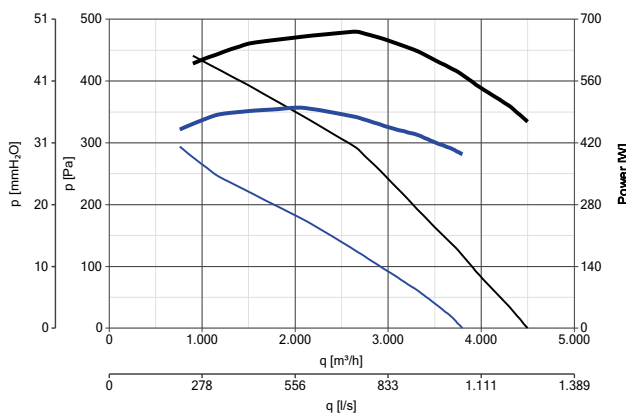

TRT 70 ED 4P

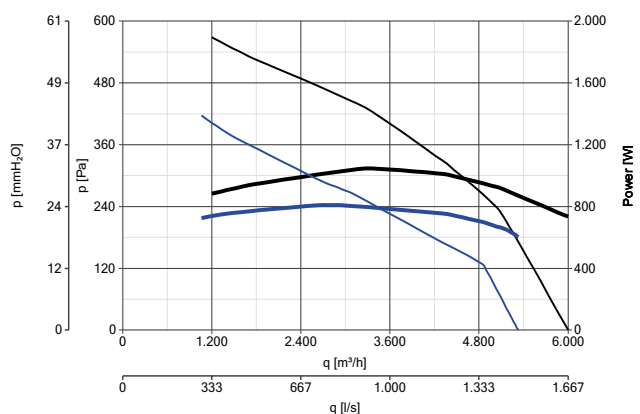

— Power consumption - max vel. — Delivery - max vel.
— Power consumption - min vel. — Delivery - min vel.



INDUSTRIAL VENTILATION

TORRETTE TR-ED RANGE

PERFORMANCE CURVES

TRT 70 ED 6P

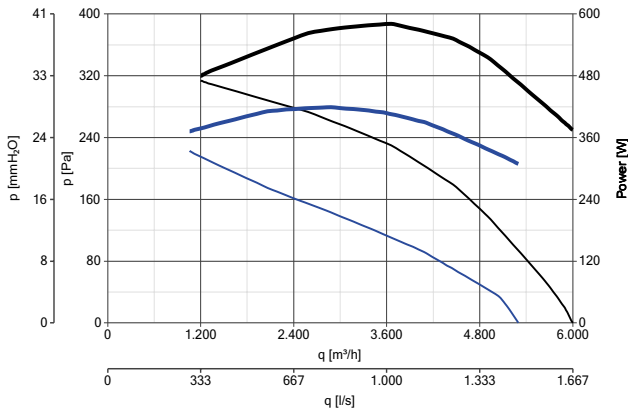

TRT 100 ED 4P

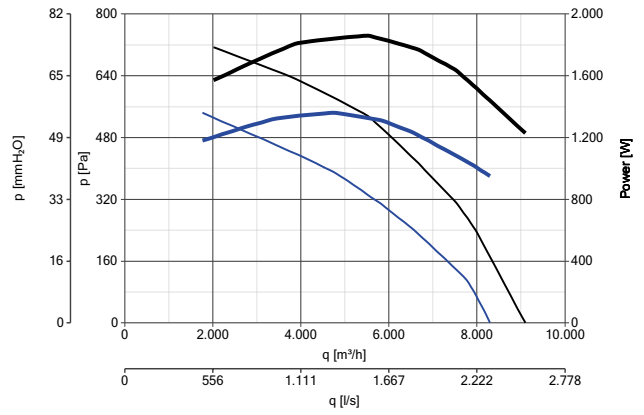

TRT 100 ED 6P

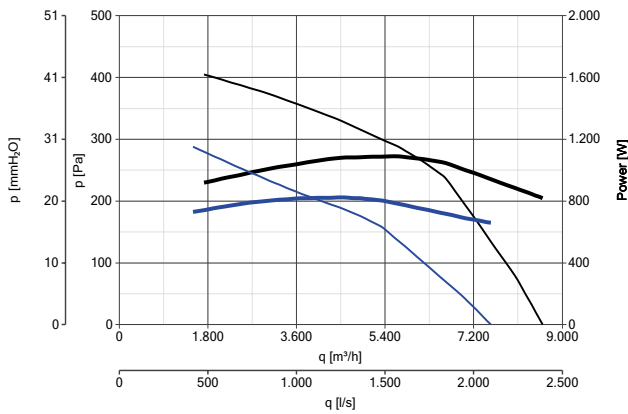

TRT 100 ED 8P

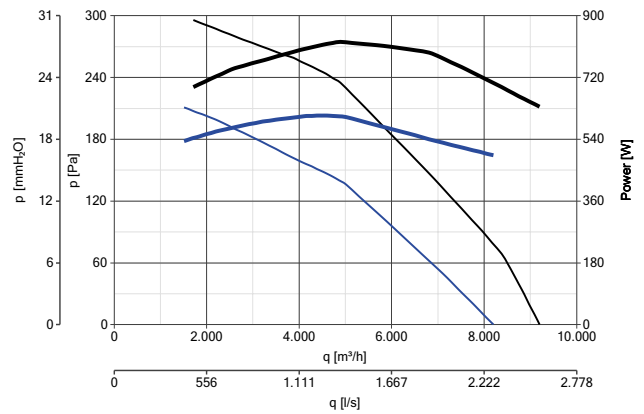

TRT 150 ED 6P

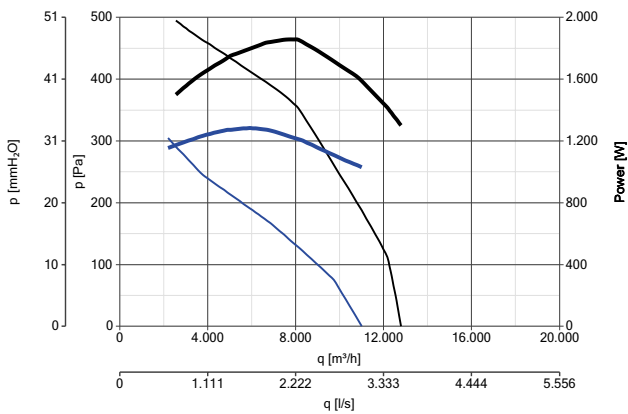

TRT 150 ED 8P

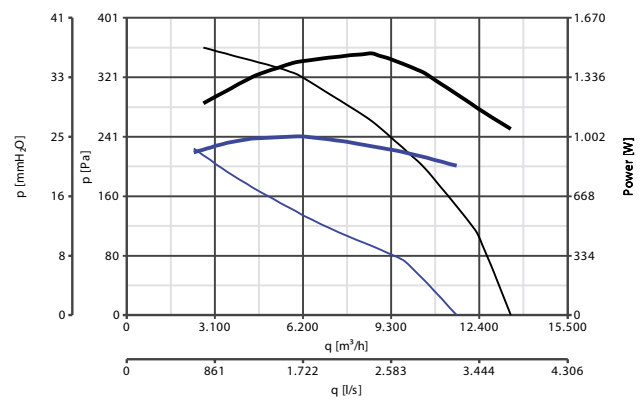

- Power consumption - max vel.
- Power consumption - min vel.
- Delivery - max vel.
- Delivery - min vel.



PERFORMANCE CURVES

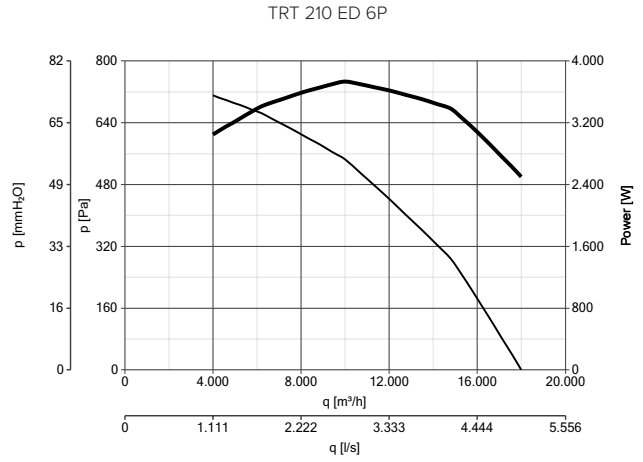
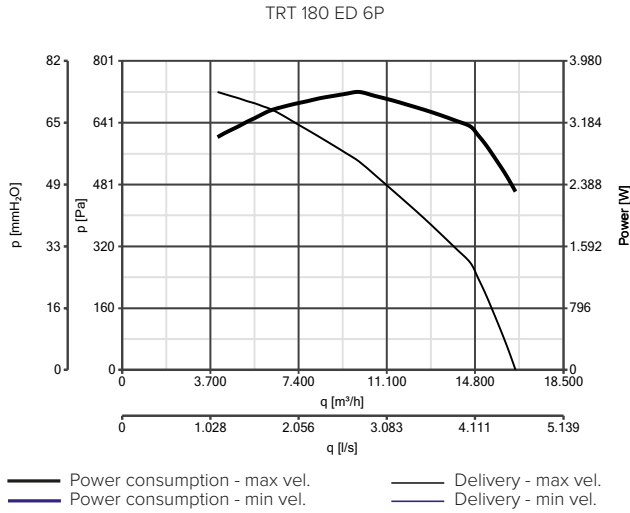

ACCESSORIES







MODELS	DESCRIPTION	CODE	PRODUCTS
		10/15 22511	15039 - 15040 - 15041 - 15042
	TR-CU - Sub-frame	20/30/50 22512	15043 - 15045 - 15046 - 15047 - 15048 - 15049
		70/100 22539	15080 - 15081 - 15082 - 15083
		100/150/180/210 22540	15084 - 15085 - 15086 - 15087 - 15919 - 15920
		10/15 22700	15039 - 15040 - 15041 - 15042
	TR-G - Intake port protection grille	20/30/50 22710	15043 - 15045 - 15046 - 15047 - 15048 - 15049
		70/100 22506	15080 - 15081 - 15082 - 15083
		100/150/180/210 22507	15084 - 15085 - 15086 - 15087 - 15919 - 15920



INDUSTRIAL VENTILATION

TORRETTE TR-ED RANGE

CONTROLLERS

MODELS	DESCRIPTION	CODE	PRODUCTS
	GV2 ME03 - Thermal-magnetic motor circuit breakers	21112	15042 - 15045
	GV2 ME05 - Thermal-magnetic motor circuit breakers	21113	15039 - 15045 - 15047
	GV2 ME05 - Thermal-magnetic motor circuit breakers	21114	15041 - 15046 - 15047 - 15049 - 15082
	GV2 ME06 - Thermal-magnetic motor circuit breakers	21115	15043 - 15049 - 15081 - 15082 - 15084
	GV2 ME07 - Thermal-magnetic motor circuit breakers	21436	15081 - 15083 - 15084 - 15085 - 15086 - 15087
	IRM 30 - Three position single-phase speed controller	12921	15039 - 15041
	IRM 40 - Three position single-phase speed controller	12922	15043 - 15046
	IRM 50 - Three position single-phase speed controller	12928	15048
	IRT 15 - Three position single-phase speed controller	12923	15040 - 15042 - 15045
	IRT 35 - Three position single-phase speed controller	12924	15047 - 15049 - 15082 - 15085
	IRT 40 - Three position single-phase speed controller	12927	15084 - 15087
	IREM 3 - Single-phase speed controller 3A	12931	15039 - 15041 - 15043 - 15046
	IREM 5 - Single-phase speed controller 5A*	12932	15048
	IREM 9 - Single-phase speed controller 9A**	12933	15080
	IRET 6 - Three-phase speed controller 6A	12934	15081 - 15082 - 15083 - 15084 - 15085 - 15086 - 15087
	IREM INVERTER 4 M - Single-phase speed controller INVERTER***	12815	15039 - 15041 - 15043 - 15046 - 15048
	IREM INVERTER 6 M - Single-phase speed controller INVERTER***	12818	15080
	IRET INVERTER 2.5 M - Three-phase speed controller INVERTER***	12816	15040 - 15042 - 15045 - 15047 - 15049 - 15081 - 15082 - 15085
	IRET INVERTER 5 M - Three-phase speed controller INVERTER***	12817	15084 - 15086 - 15087
	IRET INVERTER 8 M - Three-phase speed controller INVERTER***	12821	15083 - 15919 - 15920
	POT - Potentiometer	12828	12815 - 12816 - 12817 - 12818
	TR-CVT - Potentiometer	22910	15040 - 15042 - 15045 - 15047 - 15049 - 15081 - 15082 - 15083 - 15084 - 15085 - 15086 - 15087 - 15919 - 15920

Use in conjunction with appliances having speed selectors or controllers is not permitted in countries implementing European regulation 327/2011/EU

* Can control multiple fans up to a maximum 5A.

** Used for simultaneous control of multiple appliances up to a maximum 9A.

*** To adjust a regulator with inverter, combine a 0-10V potentiometer as code 12828





TORRETTE TR-ED-V RANGE

Centrifugal roof fans with vertical discharge for hot fumes extraction

Centrifugal roof fans with horizontal discharge, for installation in the proximity of apertures and/or air vents, certified for hot fume extraction (F400/120); available in different diameters in single and three-phase versions. They are designed to guarantee safety in civil and industrial premises such as condominiums, gyms, restaurants, offices, theatres, discos, hospitals and factories.

Key features

- Full compliance with the EN 12101-3 standard (APPLUS certification), class F400/120.
- Possibility of installation in the proximity of apertures or air vents.
- Robust and weatherproof construction.
- Easy installation on a wide range of roof types.

Versions

20 models, in single and three-phase version, with 4, 6 and 8 poles.

Technical features

- Bases made of pickled and phosphated steel sheet, grey epoxy powder-coated with hammered finish.
- Motor cover made of pickled and phosphated steel sheet, polyester powder-coated and furnace-baked, guaranteeing higher long-term resistance to aggressive agents, in grey colour with hammered finish
- Lateral bulkheads for vertical discharge of the air handled made of galvanised steel sheet, grey polyester powder-coated and furnace-baked, guaranteeing higher long-term resistance to aggressive agents and with hammered finish.
- Pickled and phosphate steel sheet motor ventilation ducts, powered by cold air taken from outside the flow handled, grey polyester powder-coated and furnace-baked, guaranteeing higher long-term resistance to aggressive agents and with hammered finish.
- Ventilation ports, fashioned in one piece with the body, characterized by aerodynamic profiles, calibrated to optimize the extracted airflow.
- Safety and anti-bird protective grilles designed in accordance with the UNI ISO 13857 standard, made of electrically welded steel rings with epoxy black paint finish.
- Galvanised steel sheet motor cover plates, designed to divert the flow of air handled, preventing it from striking the drive unit directly and thus protecting it from excessive heat loads.
- Class H single or three-phase asynchronous motors, depending on the model, with shafts turning on ball bearings with double sealing screen, characterized by high (IP55) degree of protection against dust and water and with cooling fans for more effective heat dissipation.
- Starting capacitors of the single-phase models comply with the EN 60252-1 standard and are third-party certified.
- Centrifugal impeller with electrically galvanised sheet steel self-cleaning, backward-curved blades, dynamically balanced (UNI ISO 1940, Class 6.3), fitted on grooved hubs in die-cast aluminium.
- Metal cable gland for connection to the mains, guaranteeing adequate resistance to high temperatures.
- Steel eye-bolts for lifting and transport, protected from corrosion by galvanic treatment.
- Steel cables for secure anchoring of the product to the destination surfaces supplied as standard.

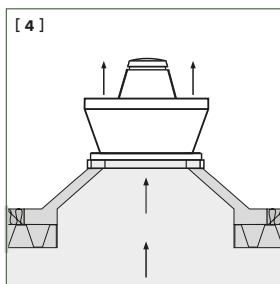
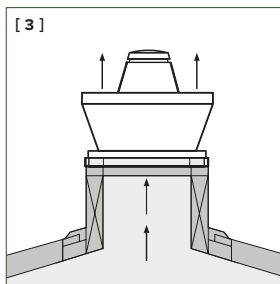
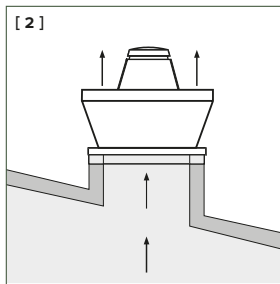
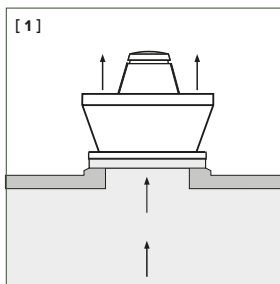

[1][2][3][4] These devices are easily installed on top of each roof. The air must not be dusty, acidic or corrosive. Not suitable for installation in ducts placed directly over chimneys or burners.

Note

- In European Community countries and in those that have implemented Reg. ErP No. 327/2011, the towers of the torrette TR ED-V range can only be used as safety equipment operating at maximum speed for the evacuation of hot fumes (class F400/120).
- In countries that are not part of the European Community or in those that have not implemented Reg. Erp No. 327/2011, the towers in the torrette TR ED-V range can be for uses other than the evacuation of hot fumes in the case of fire; as such, their speed is adjustable by Vortice controllers. For these uses, the continuous operating environmental temperature is between -25°C and + 90°C.
- The towers of the torrette TR ED-V range are not suitable for handling flows characterized by significant concentrations of abrasive dust or acid or corrosive substances.
- The towers of the torrette TR ED-V range are not suitable for installation at the end of ducts positioned directly above fireplaces or burners.

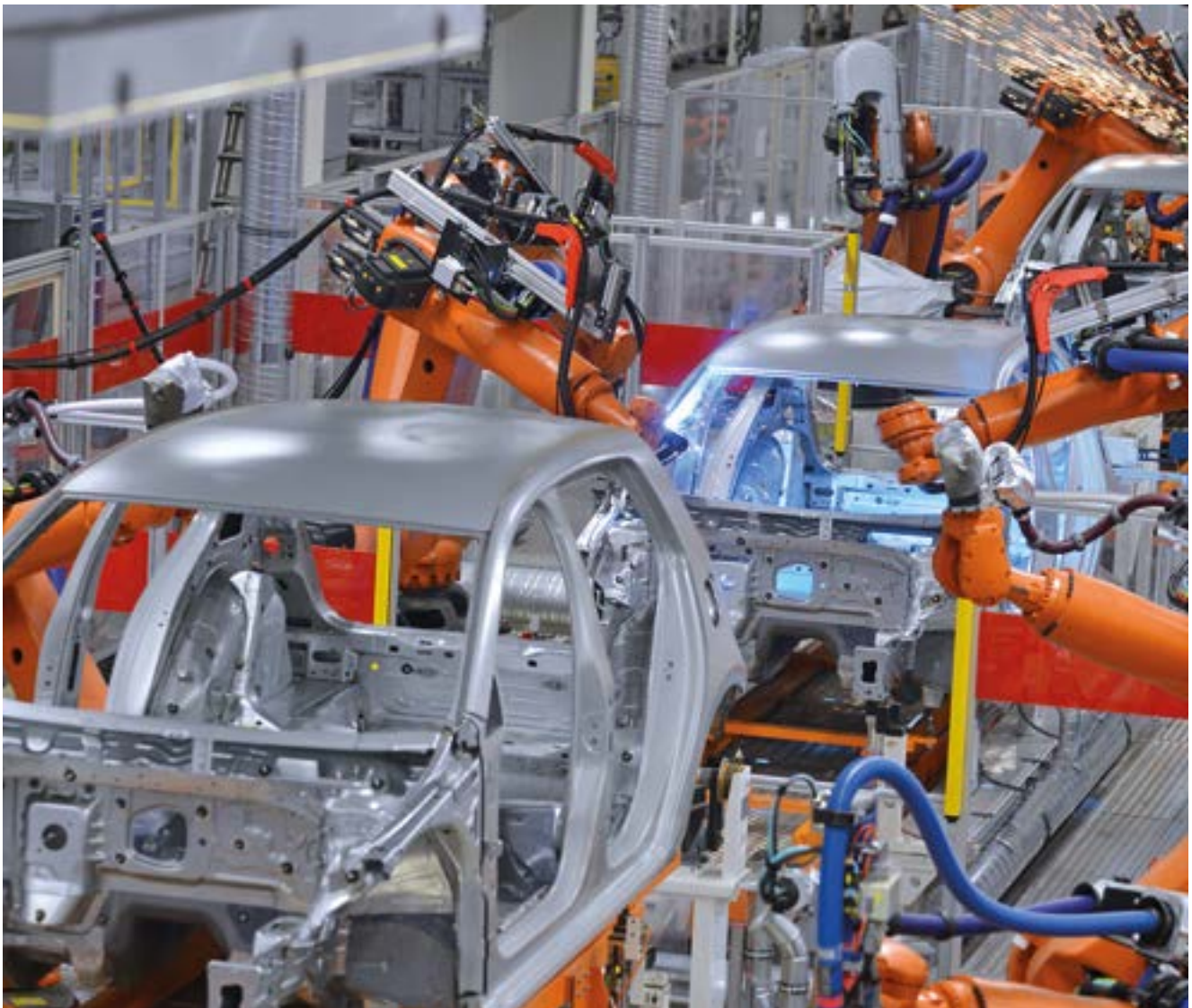



INDUSTRIAL VENTILATION

TORRETTE TR-ED-V RANGE

TECHNICAL DATA

	PRODUCTS	CODE	V~50HZ	W	A	POLES	RPM	MAX AIR FLOW		MAX PRESSURE		Lp dB(A) 3 m	MAX °C*	KG
								m³/h	l/s	mmH ₂ O	Pa			
SINGLE-PHASE	TRM 10 ED-V 4P	15160	230	100	0.45	4	1450	1000	278	20	196	56	400 °C/2H	32
	TRM 15 ED-V 4P	15162	230	130	0.57	4	1400	1400	389	24	235	58.5	400 °C/2H	33
	TRM 20 ED-V 4P	15164	230	250	1.20	4	1400	2200	611	34	334	68	400 °C/2H	61
	TRM 30 ED-V 4P	15166	230	410	1.75	4	1380	3100	861	40	392	67	400 °C/2H	63
	TRM 50 ED-V 4P	15168	230	720	3.30	4	1350	4500	1250	52	510	72.5	400 °C/2H	68
	TRM 70 ED-V 4P	15170	230	1000	4.35	4	1350	5800	1611	65	638	77	400 °C/2H	130
	TRT 10 ED-V 4P	15161	400	75 100	0.15 0.25	4	1250 1400	890 1100	247 306	17 21	167 206	56	400 °C/2H	33
TRT 15 ED-V 4P	15163	400	85 125	0.15 0.27	4	1100 1400	1100 1400	306 389	16 24	157 289	58.5	400 °C/2H	33	
TRT 20 ED-V 4P	15165	400	200 250	0.35 0.50	4	1100 1420	1800 2200	500 611	24 34	235 334	68	400 °C/2H	61	
TRT 30 ED-V 4P	15167	400	300 410	0.50 0.70	4	1100 1380	2555 3100	710 861	30 43	294 422	67	400 °C/2H	63	
TRT 50 ED-V 4P	15169	400	550 710	0.90 1.25	4	1100 1380	3800 4500	1056 1250	38 52	373 510	72.5	400 °C/2H	68	
TRT 70 ED-V 4P	15171	400	900 1100	1.50 2.00	4	1200 1400	5300 6000	1472 1667	52 67	510 657	77	400 °C/2H	128	
THREE-PHASE	TRT 70 ED-V 6P	15172	400	450 620	0.90 1.30	6	760 940	5300 6000	1472 1667	30 38	294 373	74	400 °C/2H	131
TRT 100 ED-V 4P	15173	400	1400 1870	2.40 4.50	4	1180 1400	8300 9100	2306 2528	72 84	706 824	84	400 °C/2H	132	
TRT 100 ED-V 6P	15174	400	800 1110	1.60 2.30	6	760 940	7550 8600	2097 2389	38 47	373 461	77	400 °C/2H	207	
TRT 100 ED-V 8P	15175	400	700 810	1.30 2.00	8	610 720	8200 9200	2278 2556	28 34	275 334	71	400 °C/2H	217	
TRT 150 ED-V 6P	15176	400	1470 1880	2.45 3.45	6	710 920	11000 12800	3056 3556	42 59	412 579	80	400 °C/2H	218	
TRT 150 ED-V 8P	15177	400	1170 1450	2.15 2.95	8	540 720	11600 13500	3222 3750	34 42	334 412	74	400 °C/2H	222	
TRT 180 ED-V 6P	15178	400	3200	6.11	6	950	16500	4583	79	775	83	400 °C/2H	220	
TRT 210 ED-V 6P	15179	400	3460	6.42	6	950	18000	5000	80	785	80	400 °C/2H	222	

* Maximum continuous operating temperature of the product



DIMENSIONS

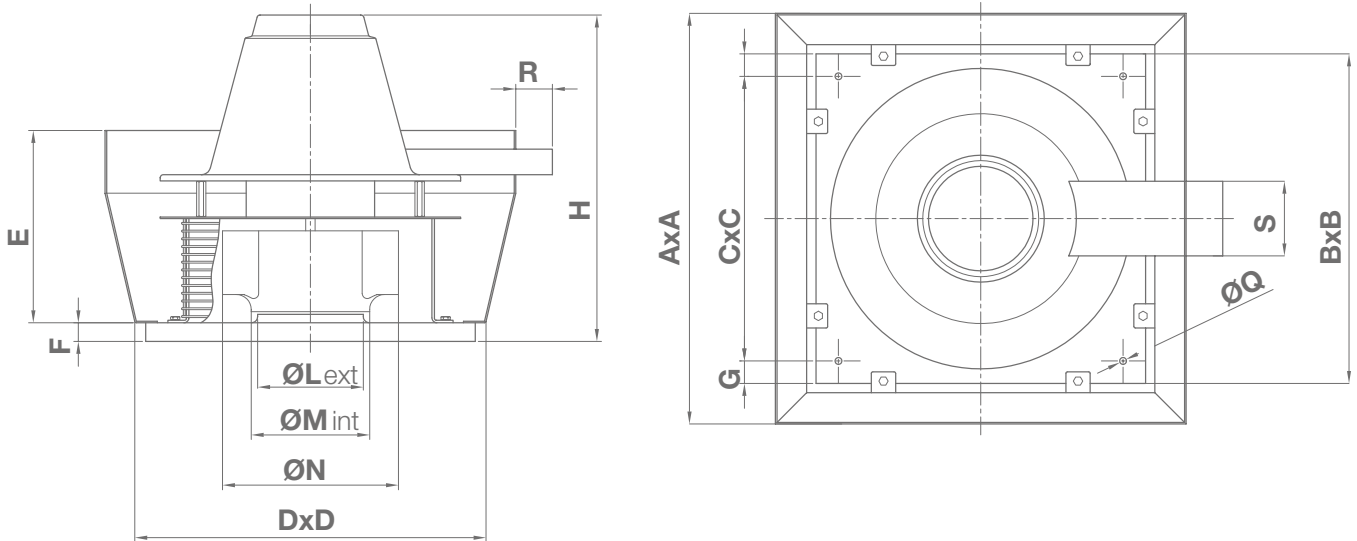

PRODUCTS	IMPELLER	ØA	ØB	ØC	ØD	E	F	G	H	ØL	ØM	ØN	ØQ	R	S
TR 10 ED-V 4P	280x101.5	652	410	357	440	328	38	26.5	538	183	187.5	284	11	40	134
TR 15 ED-V 4P	315x101.5	652	410	357	440	328	38	25	538	206	211	319	11	40	134
TR 20 ED-V 4P	355x125	907	550	500	580	432	38	25	653	231	236.5	359	11	40	158
TR 30 ED-V 4P	400x140	907	550	500	580	432	38	25	653	260	265.5	404	11	40	158
TR 50 ED-V 4P	450x160	907	550	500	580	432	38	40	669	292	298	454	11	40	158
TR 70 ED-V 4P	500x160	1144	830	750	860	491	38	40	743	328	335	504	12	50	194
TR 70 ED-V 6P	560x180	1144	830	750	860	491	38	40	743	365	375	564	12	50	194
TR 100 ED-V 4P	560x180	1144	830	750	860	491	38	40	743	365	375	564	12	50	194
TR 100 ED-V 6P	630x224	1462	980	900	1010	595	38	40	923	415	421	635	12	50	194
TR 100 ED-V 8P	710x224	1462	980	900	1010	595	38	40	923	465	472	715	12	50	194
TR 150 ED-V 6P	710x250	1462	980	900	1010	595	38	40	923	465	472	715	12	50	194
TR 150 ED-V 8P	800x250	1462	980	900	1010	595	38	40	923	520	529	805	12	50	194
TR 180 ED-V 6P	800x224	1462	980	900	1010	595	38	40	923	520	529	805	12	50	194
TR 210 ED-V 6P	800x250	1462	980	900	1010	595	38	40	923	520	529	805	12	50	194

Dimensions (mm)



PERFORMANCE CURVES

TRM 10 ED-V 4P

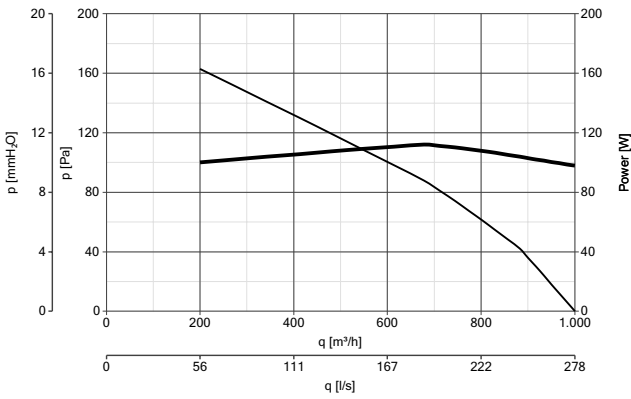

TRM 15 ED-V 4P

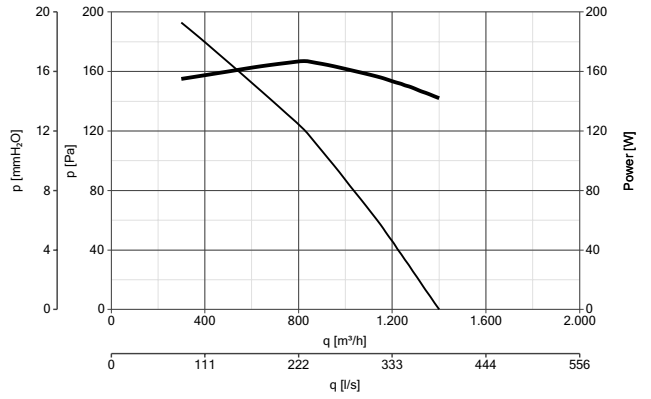

TRM 20 ED-V 4P

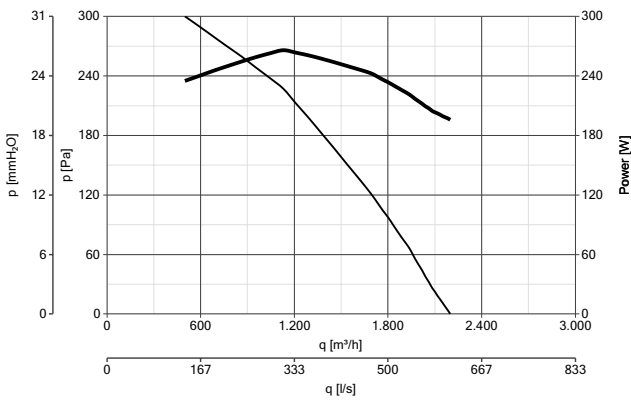

TRM 30 ED-V 4P

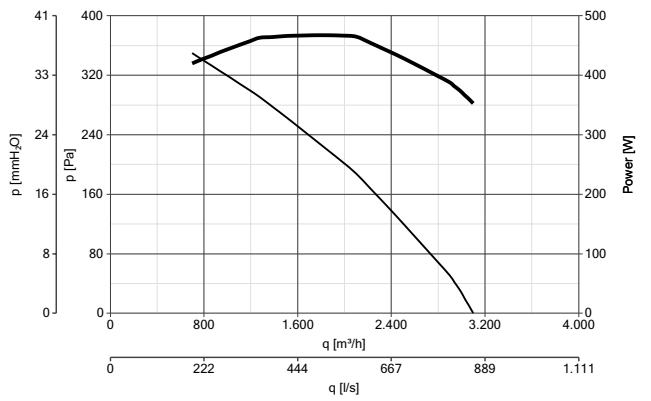

TRM 50 ED-V 4P

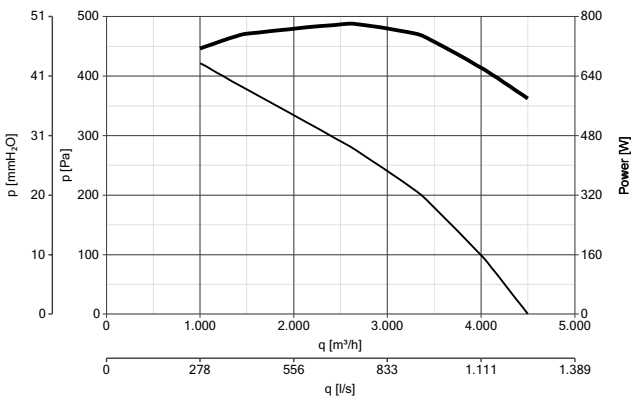

TRM 70 ED-V 4P

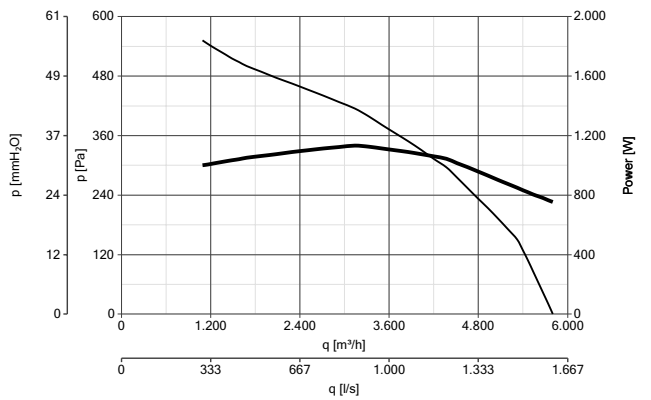

— Power consumption
— Delivery



PERFORMANCE CURVES

TRT 10 ED-V 4P

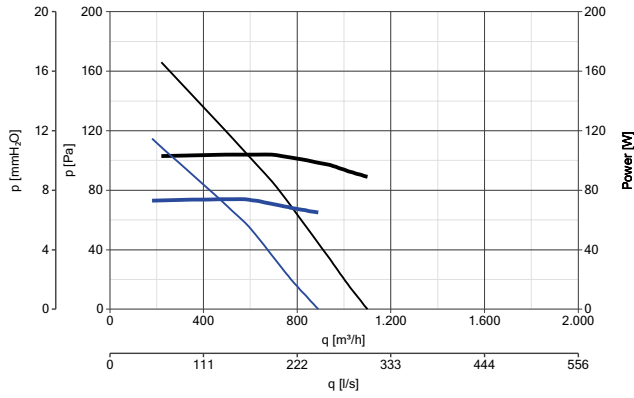

TRT 15 ED-V 4P

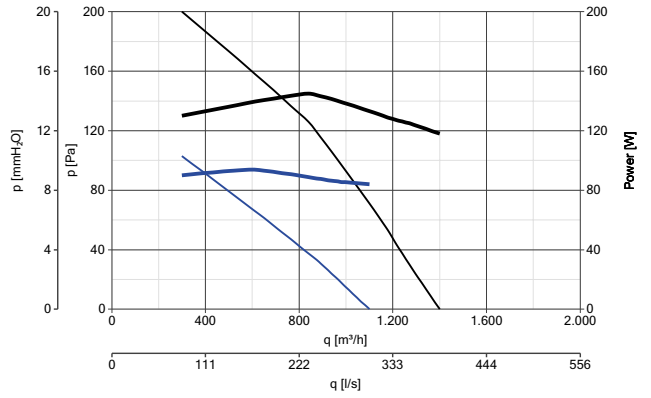

TRT 20 ED-V 4P

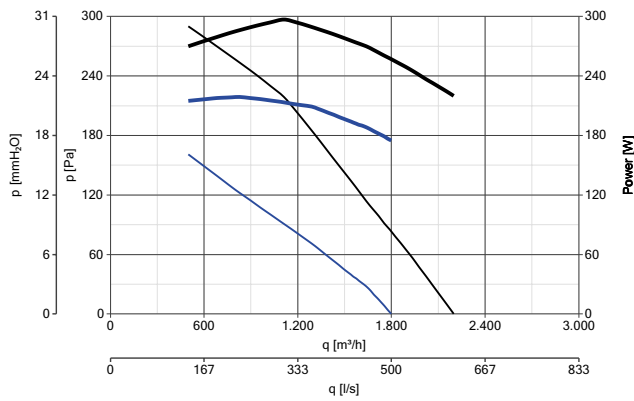

TRT 30 ED-V 4P

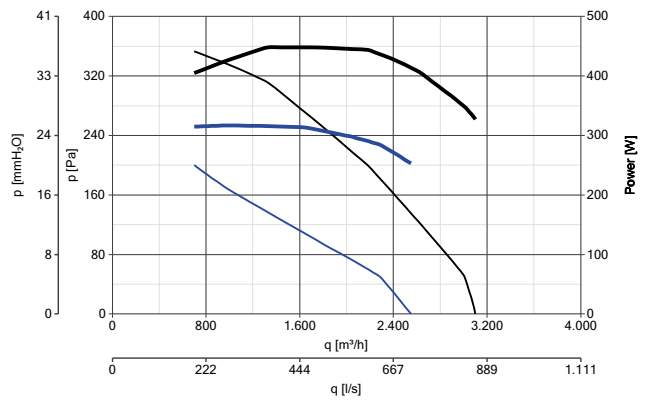

TRT 50 ED-V 4P

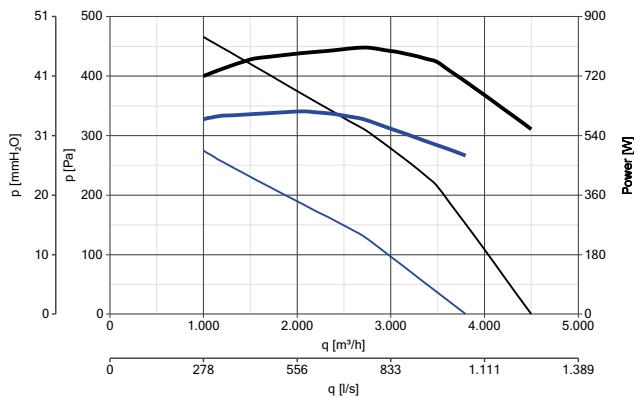

TRT 70 ED-V 4P

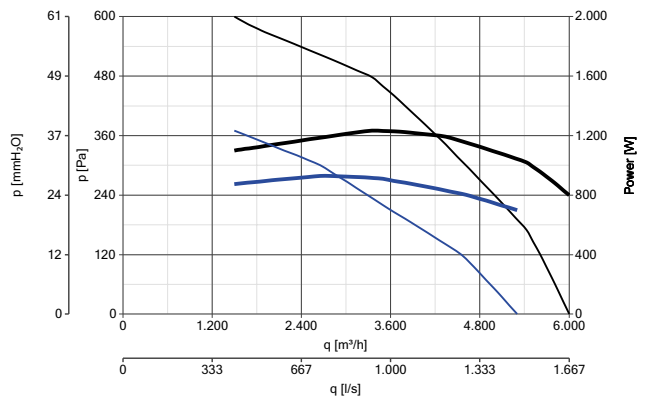

— Power consumption - max vel. — Delivery - max vel.
— Power consumption - min vel. — Delivery - min vel.



PERFORMANCE CURVES

TRT 70 ED-V 6P

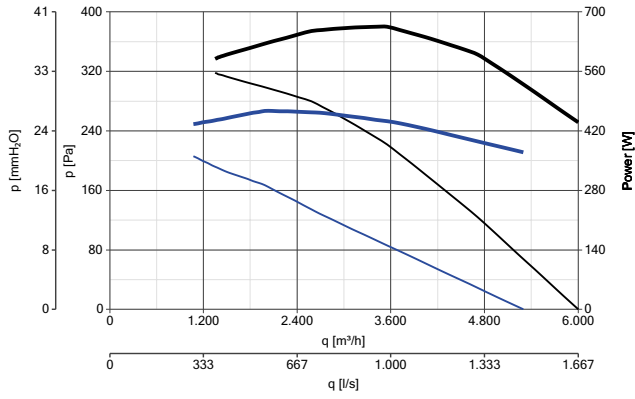

TRT 100 ED-V 4P

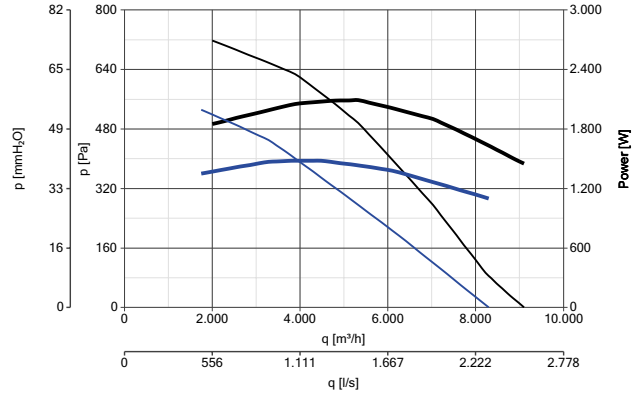

TRT 100 ED-V 6P

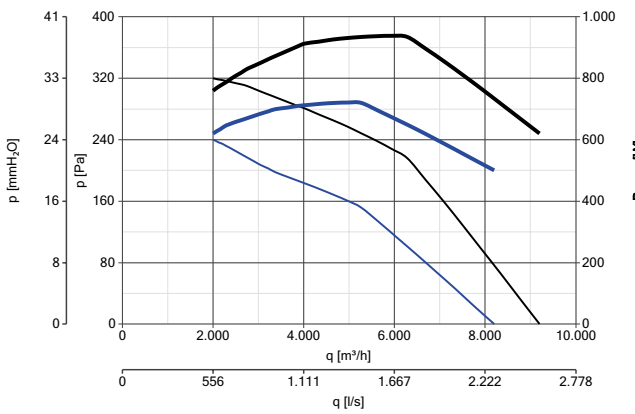

TRT 100 ED-V 8P

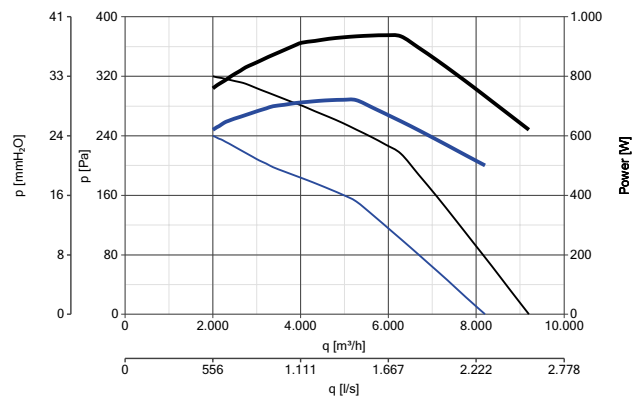

TRT 150 ED-V 6P

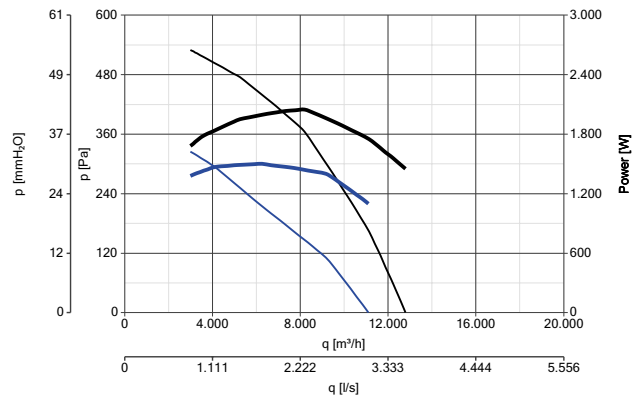

TRT 150 ED-V 8P

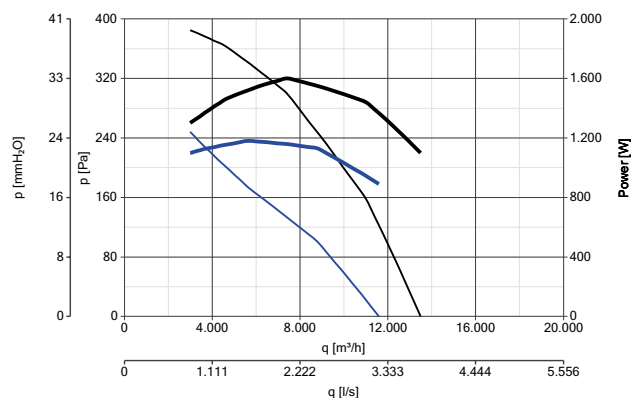

Power consumption - max vel. Delivery - max vel.
 Power consumption - min vel. Delivery - min vel.



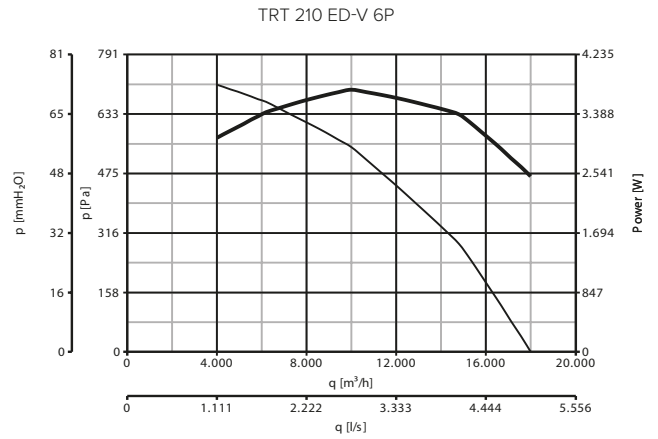
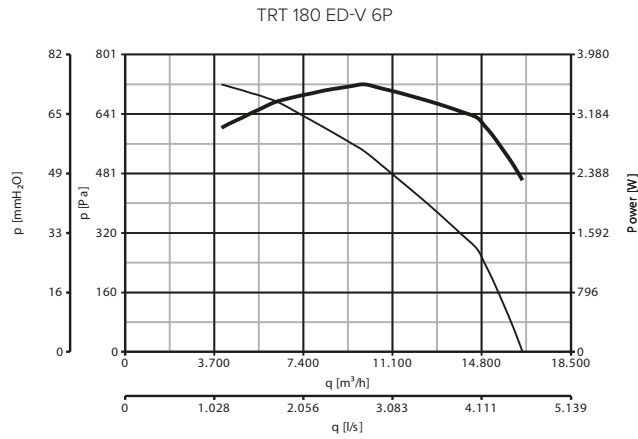

PERFORMANCE CURVES



— Power consumption - max vel. — Delivery - max vel.
— Power consumption - min vel. — Delivery - min vel.

ACCESSORIES





MODELS	DESCRIPTION	CODE	PRODUCTS	
		10/15	22511	15160 - 15161 - 15162 - 15163
		20/30/50	22512	15164 - 15165 - 15166 - 15167 - 15168 - 15169
	TR-CU - Sub-frame	70/100	22539	15170 - 15171 - 15172 - 15173
		100/150/180/210	22540	15174 - 15175 - 15176 - 15177 - 15178 - 15179
		10/15	22700	15160 - 15161 - 15162 - 15163
		20/30/50	22710	15164 - 15165 - 15166 - 15167 - 15168 - 15169
	TR-G - Intake protection grille	70/100	22506	15170 - 15171 - 15172 - 15173
		100/150/180/210	22507	15174 - 15175 - 15176 - 15177 - 15178 - 15179



INDUSTRIAL VENTILATION

TORRETTE TR-ED-V RANGE

CONTROLLERS

MODELS	DESCRIPTION	CODE	PRODUCTS
	GV2 ME03 - Thermal-magnetic motor circuit breakers	21112	15163 - 15165
	GV2 ME05 - Thermal-magnetic motor circuit breakers	21113	15160 - 15162 - 15165 - 15167
	GV2 ME05 - Thermal-magnetic motor circuit breakers	21114	15167 - 15169 - 15172
	GV2 ME06 - Thermal-magnetic motor circuit breakers	21115	15164 - 15169 - 15171 - 15172 - 15175
	GV2 ME07 - Thermal-magnetic motor circuit breakers	21436	15166 - 15171 - 15173 - 15174 - 15175 - 15176 - 15177
	IRM 30 - Three position single-phase speed controller	12921	15160 - 15162
	IRM 40 - Three position single-phase speed controller	12922	15164 - 15166
	IRM 50 - Three position single-phase speed controller	12928	15168
	IRT 15 - Three position single-phase speed controller	12923	15161 - 15163 - 15165
	IRT 35 - Three position single-phase speed controller	12924	15167 - 15169 - 15172 - 15175
	IRT 40 - Three position single-phase speed controller	12927	15171 - 15174 - 15177
	IREM 3 - Single-phase speed controller 3A	12931	15160 - 15162 - 15164 - 15166
	IREM 5 - Single-phase speed controller 5A*	12932	15168
	IREM 9 - Single-phase speed controller 9A**	12933	15170
	IRET 6 - Three-phase speed controller 6A	12934	15171 - 15172 - 15173 - 15174 - 15175 - 15176 - 15177
	IREM INVERTER 4 M - Single-phase speed controller INVERTER	12815	15160 - 15162 - 15164 - 15166
	IREM INVERTER 6 M - Single-phase speed controller INVERTER	12818	15168 - 15170
	IRET INVERTER 2.5 M - Three-phase speed controller INVERTER	12816	15161 - 15163 - 15165 - 15167 - 15169 - 15171 - 15172 - 15175
	IRET INVERTER 5 M - Three-phase speed controller INVERTER	12817	15173 - 15174 - 15176 - 15177
	IRET INVERTER 8 M - Three-phase speed controller INVERTER	12821	15178 - 15179
	POT - Potentiometer	12828	12815 - 12816 - 12817 - 12818
	TR-CVT - Potentiometer	22910	15161 - 15163 - 15165 - 15167 - 15169 - 15171 - 15172 - 15173 - 15174 - 15175 - 15176 - 15177 - 15178 - 15179

Use in conjunction with appliances having speed selectors or controllers is not permitted in countries implementing European regulation 327/2011/EU

* Can control multiple fans up to a maximum 5A.

** Used for simultaneous control of multiple appliances up to a maximum 9A.

*** To adjust a regulator with inverter, combine a 0-10V potentiometer as code 12828

**WARNING**

TR ED ROOF FANS and tr ed-v roof fans (400 °C/2h) are certified according to the en 12101-3 standard for operating at max speed; not suitable for coupling with commutators and speed controllers if used for these functions.

DECLARATION OF PERFORMANCE CE

VORTICE ELETTROSOCIALI S.p.A 
Strada Cerca, 2 - frazione di Zoate
20067 TRIBIANO Milano, Italy

hereby declares that the performance of products:

Models	Code	Notified Body	Models	Code	Notified Body
TRM 10 ED 4P	15039	TÜV	TRM 10 ED-V 4P	15160	APPLUS
TRT 10 ED 4P	15040	TÜV	TRT 10 ED-V 4P	15161	APPLUS
TRM 15 ED 4P	15041	TÜV	TRM 15 ED-V 4P	15162	APPLUS
TRT 15 ED 4P	15042	TÜV	TRT 15 ED-V 4P	15163	APPLUS
TRM 20 ED 4P	15043	TÜV	TRM 20 ED-V 4P	15164	APPLUS
TRT 20 ED 4P	15045	TÜV	TRT 20 ED-V 4P	15165	APPLUS
TRM 30 ED 4P	15046	TÜV	TRM 30 ED-V 4P	15166	APPLUS
TRT 30 ED 4P	15047	TÜV	TRT 30 ED-V 4P	15167	APPLUS
TRM 50 ED 4P	15048	TÜV	TRM 50 ED-V 4P	15168	APPLUS
TRT 50 ED 4P	15049	TÜV	TRT 50 ED-V 4P	15169	APPLUS
TRM 70 ED 4P	15080	TÜV	TRM 70 ED-V 4P	15170	APPLUS
TRT 70 ED 4P	15081	TÜV	TRT 70 ED-V 4P	15171	APPLUS
TRT 70 ED 6P	15082	TÜV	TRT 70 ED-V 6P	15172	APPLUS
TRT 100 ED 4P	15083	TÜV	TRT 100 ED-V 4P	15173	APPLUS
TRT 100 ED 6P	15084	TÜV	TRT 100 ED-V 6P	15174	APPLUS
TRT 100 ED 8P	15085	TÜV	TRT 100 ED-V 8P	15175	APPLUS
TRT 150 ED 6P	15086	TÜV	TRT 150 ED-V 6P	15176	APPLUS
TRT 150 ED 8P	15087	TÜV	TRT 150 ED-V 8P	15177	APPLUS
TRT 180 ED 6P	15919	APPLUS	TRT 180 ED-V 6P	15178	APPLUS
TRT 210 ED 6P	15920	APPLUS	TRT 210 ED-V 6P	15179	APPLUS

used for the evacuation of fumes and heat, is as follows:

Essential characteristics	Performance	Harmonised standard
400° C for a duration of 12 minutes	F400	Smoke and heat control system <i>Specification for powered smoke and heat exhaust ventilators</i> EN 12101-3(2002)+AC(2005)

verified by the following European Notified Bodies:

TÜV SÜD INDUSTRIE SERVICE GMBH MÜNCHEN : Certification Body N° 0036:

Certified No.:

- 0036 CPD RG03 01
- 0036 CPD RG03 02
- 0036 CPD RG03 03
- 0036 CPD RG03 04

APPLUS- LGAI TECHNOLOGICAL CENTRE SA : Certification Body N° 0370

Certified No.:

- 0370 CPR 0860
- 0370 CPR 0861

The consistent performance of the above products is guaranteed by a Grade 1 system, in accordance with appendix V of European Regulation No: **305/2011 (EU)**

ACCESSORIES
MODELS
DESCRIPTION
DPU

Spacer for panel installation (Vortice E and Vortice A-E) to be used in case of impossibility of direct application on the wall.

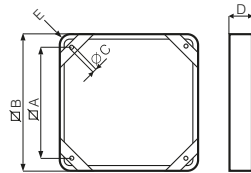

PRODUCTS	CODE	ØA	ØB	ØC	D	E
DPU 250	52151	280	312	8	100	16
DPU 300	52251	330	372	8	100	21
DPU 350	52351	380	442	8	100	31
DPU 400	52451	430	502	8	115	36

Dimensions (mm)

PGR

Gravity shutter to be applied to the product on the delivery side to avoid air re-entry when the product is switched off.



PRODUCTS	CODE	ØA	ØB	C	ØD	E
PGR 250	50150	296	280	6	20	68
PGR 300	50250	346	330	6	20	68
PGR 350	50350	396	380	6	20	68
PGR 400	50450	446	430	6	20	117
PGR 450/500	50550	546	530	6	20	117

Dimensions (mm)

TRA

To be applied to the product on the delivery side to protect the moving parts if the appliance is installed in an accessible position (Standard EN 294).

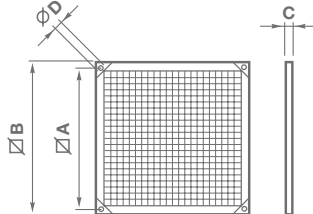

PRODUCTS	CODE	ØA	ØB	C	ØD
TRA 250	51150	280	305	8	10
TRA 300	51250	330	355	8	10
TRA 350	51350	380	405	8	10
TRA 400	51450	430	455	8	10
TRA 450/500	51550	530	555	8	10

Dimensions (mm)

T-GM

Supply side protection grille (Vortice C E). To be applied to the product on the delivery side to protect the moving parts if the appliance is installed in an accessible position (Standard EN 294).

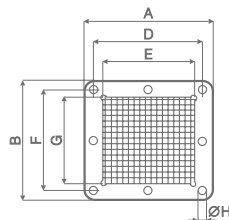

PRODUCTS	CODE	A	B	C	D	E	F	G	ØH	N. FISS.
C-GM 10	22811	98	88		82	67.5	72	67.5	6.5	
C-GM 15	22812	125	132		100	90.5	108	90.5	7	
C-GM 20	22813	145	145		123	102	123	102		4
C-GM 25	22814	164	146		142		124			
C-GM 30	22816	162	150		137	113.5	126	113.5		
C-GM 31	22817	165	190	1	139		164	136.5	8.5	
C-GM 35	22818	200	190		174					
C-GM 37	22819	212	205		182	148	220			
C-GM 40	22820	244	250		208	182.5	214	182.5		8
C-GM 45	22821	260	260		228	205.5	228	205.5	9	
C-GM 46	22822	295	336		265	240	306	274.5	11.5	

Dimensions (mm)



ACCESSORIES

MODELS

DESCRIPTION

C-GA

Intake port protection grille (Vortice C E). Fitted to the appliance delivery side to prevent accidental contact with moving parts if the appliance is installed in an accessible position.

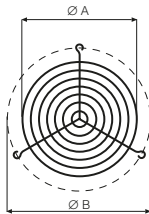
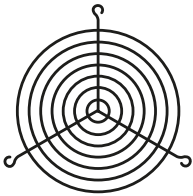

PRODUCTS	CODE	ØA	ØB	N. FISS.
C-GA 10	22801	80	104	3x120°
C-GA 15	22802	100	134	
C-GA 20/25	22803	120	142	
C-GA 30	22804	140	176	
C-GA 31/35	22805	180	220	4x90°
C-GA 37/40	22806	220	262	
C-GA 45	22807	260	300	
C-GA 46	22808	340	395	

Dimensions (mm)

TR-G

Intake port protection grille (Torrette RF-EU, TR E, TR E-V, TR ED, TR ED-V). Fitted to the appliance intake to prevent accidental contact with moving parts if the appliance is installed in an accessible position (Standard EN 294)

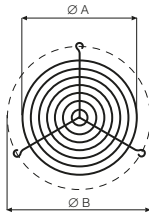

PRODUCTS	CODE	ØA	ØB	N. FISS.
TR-G 10/15	22700	223	254	4x90°
TR-G 20/30/50	22710	323	359	
TR-G 70/100	22506	463	500	6x60°
TR-G 100/150/180/210	22507	588	640	

Dimensions (mm)

MPC RP

Protection grille (Vortice MPC-E). Fitted on top of the appliance intake to prevent accidental contact with moving parts if the appliance is installed in an accessible position (STANDARD EN 294)

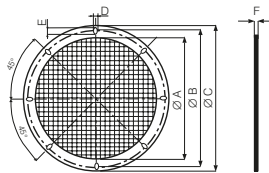

PRODUCTS	CODE	ØA	ØB	ØC	DXE	F
MPC RP 250	22527	260	292	292	9x14	8
MPC RP 250	22528	312	366	366		
MPC RP 250	22529	364	405	405		
MPC RP 250	22530	414	448	448		

Dimensions (mm)

TR-S

Galvanized sheet-metal backdraught shutter (Torrette RF-EU, TR E, TR E-V, TR ED, TR ED-V). Fitted to the appliance delivery side to prevent air from reentering when the appliance is switched off.

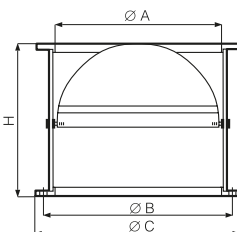

PRODUCTS	CODE	ØA	ØB	ØC	H
TR-S 10/15	22500	225	254	270	210
TR-S 20/30/50	22510	327	359	375	
TR-S 70/100	22541	430	500	520	260
TR-S 100/150/180/210	22542	570	640	660	330

Dimensions (mm)

ACCESSORIES
MODELS
DESCRIPTION
MPC BO

Intake nozzle (Vortice MPC-E). To facilitate air entry from the intake side.

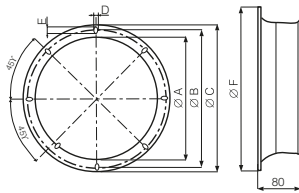

PRODUCTS	CODE	ØA	ØB	ØC	DXE	ØF
MPC BO 250	22535	260	292	310	9x14	323
MPC BO 300	22536	312	366	384		384
MPC BO 350	22537	364	405	423		440
MPC BO 400	22538	414	448	466		500

Dimensions (mm)

TR-B

Section connector (Torrette RF-EU, TR E, TR E-V, TR ED, TR ED-V). To facilitate air entry from the intake side.

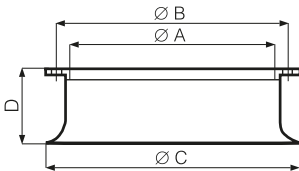

PRODUCTS	CODE	ØA	ØB	ØC	D
TR-B 10/15	22600	275	80	225	254
TR-B 20/30/50	22610	380		330	359
TR-B 70/100	22508	480	100	430	500
TR-B 100/150/180/210	22509	620		570	640

Dimensions (mm)

MPC FL

Flange fitting (Vortice MPC-E). To make it easier to join the appliance to the intake or outlet pipe.

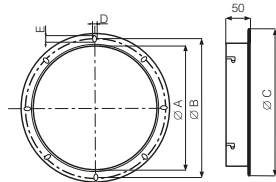

PRODUCTS	CODE	ØA	ØB	ØC	DXE
MPC FL 250	22523	260	292	318	9x14
MPC FL 300	22524	312	366	392	
MPC FL 350	22525	364	405	431	
MPC FL 400	22526	414	448	472	

Dimensions (mm)

C-RA

Flanged fitting for intake tube (Vortice C E) To make it easier to join the appliance to the intake or outlet pipe.

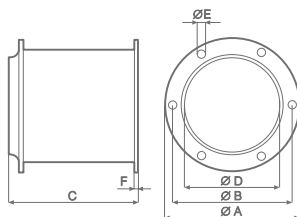

PRODUCTS	CODE	ØA	ØB	C	ØD	ØE	F
C-RA 10	22825	111.5	100	83	80	7	0.8
C-RA 15	22826	141	128	114	108		
C-RA 20/25	22828	152	132	117	108		
C-RA 30	22829	190	170	141	132	—	—
C-RA 31/35	22830	240	210	169	170		
C-RA 37	22832	282	255	224	199		
C-RA 40	22833	282	255	229	199	8.5	—
C-RA 45	22834	320	290	235	240		
C-RA 46	22835	420	390	270	288	—	—

Dimensions (mm)



ACCESSORIES

MODELS

DESCRIPTION

MPC RA

Flexible fitting (Vortical MPC-E). To make it easier to join the appliance to the intake or outlet pipe.

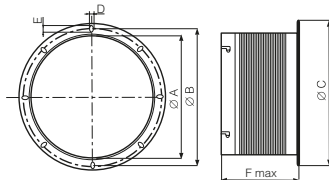

PRODUCTS	CODE	ØA	ØB	ØC	DXE	F MAX
MPC RA 250	22527	260	292	318	9x14	200
MPC RA 300	22528	312	366	392		225
MPC RA 350	22529	364	405	431		200
MPC RA 400	22530	414	448	472		

Dimensions (mm)

TR-CU

Installation base counter-frame (Torrette RF-EU, TR E, TR E-V, TR ED, TR ED-V). To fix the fan to the wall.

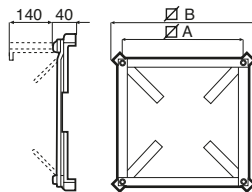

PRODUCTS	CODE	ØA	ØB
TR-CU 10/15	22511	357	401
TR-CU 20/30/50	22512	500	541
TR-CU 70/100	22539	750	791
TR-CU 100/150/180/210	22540	900	941

Dimensions (mm)

MPC SU

Wall mounting brackets (Vortical MPC-E).

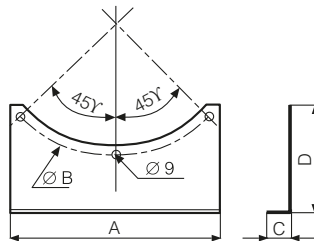

PRODUCTS	CODE	A	ØB	C	D
MPC SU 250	22531	240	292	25	120
MPC SU 300	22532	295	366		130
MPC SU 350	22533	320	405	140	
MPC SU 400	22534	360	448		

Dimensions (mm)

C-MS

Support for wall mounting with fixings (Vortical C E) To fix the fan to the wall.

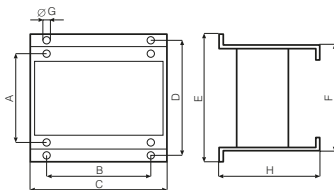

PRODUCTS	CODE	A	B	C	D	E	F	ØG	H	MEC
C-MS 20/25	22836	112	90	120	187	220	152	8	125	71
C-MS 30	22837	112	90	120	187	220	160	8	170	71
C-MS 31/35	22838	112	90	120	187	220	160	8	200	71
C-MS 37/40	22839	125	100	140	200	235	165	10	230	80
C-MS 45	22840	140	125	175	215	250	180	10	300	90

Dimensions (mm)



ACCESSORIES

MODELS DESCRIPTION

SLE

Silencers.

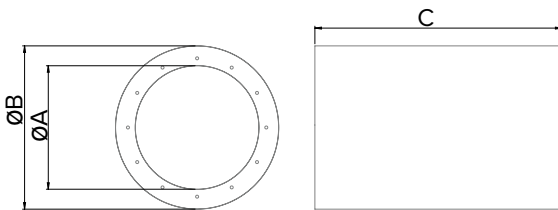

PRODUCTS	CODE	Ø MPC	ØA	ØB	C	KG
SLE 1D 400	21238	400	400	500	400	7,35
SLE 1D 800	21343	400	400	500	800	13,6
SLE 1D 450	21226	450	450	550	450	9,08
SLE 2D 450	21331	450	450	550	900	16,93
SLE 1D 500	21239	500	500	660	500	15,09
SLE 2D 500	21344	500	500	660	1000	27,9
SLE 1D 560	21240	560	560	720	560	18,42
SLE 2D 560	21345	560	560	720	1120	34,06
SLE 1D 630	21241	630	630	790	630	22,82
SLE 2D 630	21346	630	630	790	1260	42,87
SLE 1D 710	21242	710	710	870	710	28,34
SLE 2D 710	21347	710	710	870	1420	53,63
SLE 1D 800	21243	800	800	960	800	35,31
SLE 2D 800	21348	800	800	960	1600	67,08
SLE 1D 900	21244	900	900	1100	900	48,41
SLE 2D 900	21349	900	900	1100	1800	91,42
SLE 1D 1000	21245	1000	1000	1200	1000	66,95
SLE 2D 1000	21350	1000	1000	1200	2000	117,08
SLE 1D 1120	21246	1120	1120	1320	1120	72,79
SLE 2D 1120	21351	1120	1120	1320	2240	139,59
SLE 1D 1250	21247	1250	1250	1450	1250	89,51
SLE 2D 1250	21352	1250	1250	1450	2500	172,41
SLE 1D 1400	21248	1400	1400	1600	1400	110,92
SLE 2D 1400	21353	1400	1400	1600	2800	214,48

Dimensions (mm)

MODELS DESCRIPTION

SLE-P

Silencers with pod.

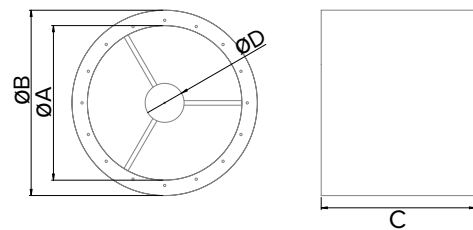

PRODUCTS	CODE	Ø MPC	ØA	ØB	C	ØD	KG
SLE-P 1D 400	21225	400	400	500	400	150	8,96
SLE-P 2D 400	21320	400	400	500	800	150	16,61
SLE-P 1D 450	21227	450	450	550	450	150	10,91
SLE-P 2D 450	21332	450	450	550	900	150	20,38
SLE-P 1D 500	21228	500	500	660	500	150	17,18
SLE-P 2D 500	21333	500	500	660	1000	150	31,76
SLE-P 1D 560	21229	560	560	720	560	150	20,72
SLE-P 2D 560	21334	560	560	720	1120	150	38,31
SLE-P 1D 630	21230	630	630	790	630	150	25,21
SLE-P 2D 630	21335	630	630	790	1260	150	49
SLE-P 1D 710	21231	710	710	870	710	250	34,23
SLE-P 2D 710	21336	710	710	870	1420	250	65,32
SLE-P 1D 800	21232	800	800	960	800	250	41,88
SLE-P 2D 800	21337	800	800	960	1600	250	79,71
SLE-P 1D 900	21233	900	900	1100	900	250	55,58
SLE-P 2D 900	21338	900	900	1100	1800	250	105,13
SLE-P 1D 1000	21234	1000	1000	1200	1000	350	83,31
SLE-P 2D 1000	21339	1000	1000	1200	2000	350	137,57
SLE-P 1D 1120	21235	1120	1120	1320	1120	350	88,29
SLE-P 2D 1120	21340	1120	1120	1320	2240	350	169,61
SLE-P 1D 1250	21236	1250	1250	1450	1250	350	106,69
SLE-P 2D 1250	21341	1250	1250	1450	2500	350	205,79
SLE-P 1D 1400	21237	1400	1400	1600	1400	350	130,04
SLE-P 2D 1400	21342	1400	1400	1600	2800	350	251,73

Dimensions (mm)



ACCESSORIES

MODELS	DESCRIPTION
--------	-------------

XS

Enclosed spring anti-vibration mounts.

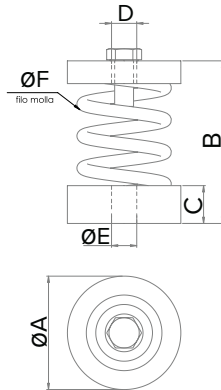

PRODUCTS	CODE	ØA	B	C	D	ØE	ØF	KG
XS-12/50	21251						5	0,3
XS-13/75	21252						5,6	0,35
XS-14/125	21253	60	86	9	M10	18	6,6	0,40
XS-16/175	21254						7	0,45
XS-17/200	21255						8	0,50

Dimensions (mm)

PRODUCTS	CODE	NOTE
XS-12/50	21251	MAXIMUM LOAD: 50 KG
XS-13/75	21252	MAXIMUM LOAD: 75 KG
XS-14/125	21253	MAXIMUM LOAD: 125 KG
XS-16/175	21254	MAXIMUM LOAD: 175KG
XS-17/200	21255	MAXIMUM LOAD: 200 KG

Dimensions (mm)

MODELS	DESCRIPTION
--------	-------------

MFL

Galvanized counter flanges.

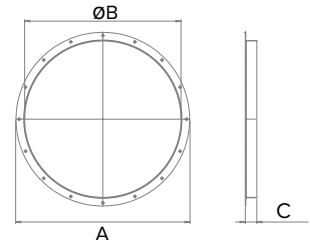

MODELS	CODE	Ø MPC	A	ØB	C	KG
MFL 400	21256	400	475	400	64,8	2
MFL 450	21257	450	530	450	62,3	2,3
MFL 500	21258	500	585	500		2,5
MFL 560	21259	560	645	560		2,8
MFL 630	21260	630	715	630	59,8	3,2
MFL 710	21261	710	795	710		3,5
MFL 800	21262	800	885	800		4
MFL 900	21263	900	1000	900	52,3	4,5
MFL 1000	21264	1000	1100	1000	74	9,3
MFL 1120	21265	1120	1240	1120	69	10,5
MFL 1250	21266	1250	1380	1250	64	11,7
MFL 1400	21267	1400	1540	1400	59	13,1

Dimensions (mm)

MODELS	DESCRIPTION
--------	-------------

MSC

Galvanized wire guard.

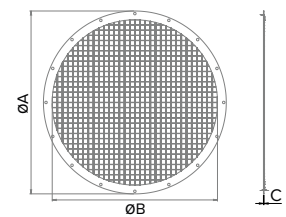

MODELS	CODE	Ø MPC	ØA	ØB	C	KG
MSC 400	21268	400	475	400		1,4
MSC 450	21502	450	530	450		1,7
MSC 500	21503	500	585	500		2,1
MSC 560	21504	560	645	560		2,4
MSC 630	21505	630	715	630		2,8
MSC 710	21506	710	795	710		3,2
MSC 800	21507	800	885	800	3	3,9
MSC 900	21508	900	1000	900		4,6
MSC 1000	21509	1000	1100	1000		5,4
MSC 1120	21510	1120	1240	1120		6,2
MSC 1250	21511	1250	1380	1250		7,7
MSC 1400	21512	1400	1540	1400		9,2

Dimensions (mm)

ACCESSORIES
MODELS
DESCRIPTION
EBY

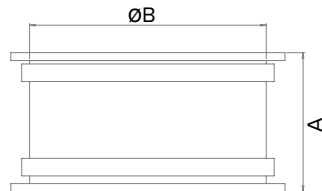
 Circular flexible connections,
resistant up to 70 °C.

MODELS	CODE	Ø MPC	A	ØB	KG
EBY 400	21309	400	150	400	1
EBY 450	21513	450		450	1,2
EBY 500	21310	500		500	1,4
EBY 560	21311	560		560	1,6
EBY 630	21312	630	200	630	1,8
EBY 710	21313	710		710	1,9
EBY 800	21314	800		800	2
EBY 900	21315	900		900	2,2
EBY 1000	21316	1000	250	1000	2,4
EBY 1120	21317	1120		1120	2,6
EBY 1250	21318	1250		1250	3
EBY 1400	21319	1400		1400	3,2

Dimensions (mm)

MODELS
DESCRIPTION
MFT

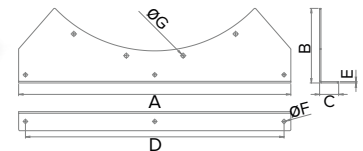
 Mounting brackets made
of hot-dip galvanized steel.

MODELS	CODE	A	B	C	D	E	ØF	ØG	KG
MFT 400	21309	400	103		350		9		1,1
MFT 450	21513	450	121	50	400	3	10		1,3
MFT 500	21310	500	152		450				1,7
MFT 560	21311	560	167		510			12	2,8
MFT 630	21312	630	193		580				3,5
MFT 710	21313	710	193	60	660	4	11		4
MFT 800	21314	800	211		750				4,7
MFT 900	21315	900	235	66	850				6
MFT 1000	21316	1000	274		950				9,3
MFT 1120	21317	1120	340		1070			15	12,1
MFT 1250	21318	1250	406	70	1180	5	13		14,9
MFT 1400	21319	1400	462		1300				19

Dimensions (mm)

MODELS
DESCRIPTION
MPT

Mounting plate.

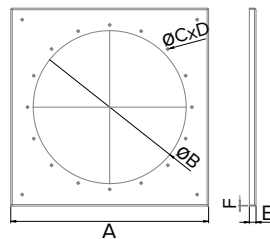
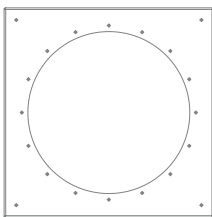

MODELS	CODE	Ø MPC	A	ØB	ØC	D	E	F	KG
MPT 400	21526	400	625	400				3	8
MPT 450	21527	450	680	450					11,9
MPT 500	21528	500	735	500					13,4
MPT 560	21529	560	795	560	12	12			14,9
MPT 630	21530	630	865	630				4	16,7
MPT 710	21531	710	945	710				35	18,9
MPT 800	21532	800	1035	800					21,5
MPT 900	21533	900	1150	900				16	25,6
MPT 1000	21534	1000	1250	1000					35,6
MPT 1120	21535	1120	1365	1120	15				40
MPT 1250	21536	1250	1500	1250		20		5	46,3
MPT 1400	21537	1400	1650	1400					53,3

Dimensions (mm)

MODELS
DESCRIPTION
MFT-C

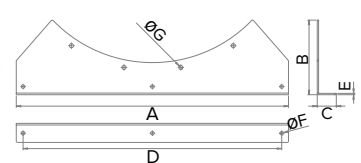
 Mounting brackets made of
epoxy coated steel.

MODELS	CODE	A	B	C	D	E	ØF	ØG	KG
MFT-C 400	21281	400	103		350		9		1,1
MFT-C 450	21282	450	121	50	400	3	10		1,3
MFT-C 500	21283	500	152		450				1,7
MFT-C 560	21284	560	167		510			12	2,8
MFT-C 630	21285	630	193		580				3,5
MFT-C 710	21289	710	193	60	660	4	11		4
MFT-C 800	21287	800	211		750				4,7
MFT-C 900	21288	900	235	66	850				6
MFT-C 1000	21289	1000	274		950				9,3
MFT-C 1120	21290	1120	340		1070			15	12,1
MFT-C 1250	21291	1250	406	70	1180	5	13		14,9
MFT-C 1400	21292	1400	462		1300				19

Dimensions (mm)



ACCESSORIES

MODELS

DESCRIPTION

NRDO

Axial fans for round back draft
Galvanised steel casing and
aluminum damper.

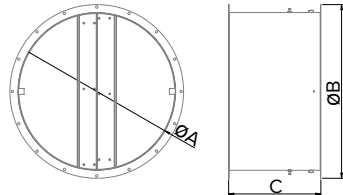

MODELS	CODE	Ø MPC	ØA	ØB	C	KG
NRDO 400	21514	400	400	475	325	9,9
NRDO 450	21515	450	450	530	345	11,77
NRDO 500	21516	500	500	585	340	13,35
NRDO 560	21517	560	560	645	365	15,82
NRDO 630	21518	630	630	715	385	18,53
NRDO 710	21519	710	710	795	425	22,30
NRDO 800	21520	800	800	885	470	27,52
NRDO 900	21521	900	900	1000	525	34,45
NRDO 1000	21522	1000	1000	1100	540	40,02
NRDO 1120	21523	1120	1120	1240	625	50,85
NRDO 1250	21524	1250	1250	1380	675	61,50
NRDO 1400	21525	1400	1400	1540	755	76,34

Dimensions (mm)

CONTROLLERS

SINGLE-PHASE SPEED CONTROLLER WITH INVERTER

Frequency variation speed regulator (Inverter) with single-phase power supply for the control of one or more single-phase AC motors also not specifically designed for frequency variation regulation.

Enclosure for wall installation featuring IP54 protection.

Maximum length of the power cables to the slave not limited, even in the case of using unshielded cables. Maximum length of the signal cable equal to 30 m in the case of shielded conductors (20 m using unshielded cables); for longer lengths use signal amplifiers.

Analog input for speed selection (0-10 V signal; 0-20 mA or PWM). Digital input (24 V) for connecting external devices, such as adjustment potentiometers.

Integrated motor protection; possibility of connection to "TB" thermostats or "TP" thermistors; in the case of simultaneous control of several fans, thermostats or thermistors must be connected in range.

Switching frequency of 16 kHz (to guarantee regular and silent operation of the slave motor).

EMC filter and omnipolar sinusoidal filter (phase-phase and phase-earth) integrated.

Maximum Relative Humidity (RH) of the target environment: up to 85%, in the absence of condensation.

Maximum altitude: 4,000 m (over 1,000 m the nominal current must be reduced by 5% every 1,000 m).

Ambient temperature max continuous operation: 35 ° C

Three-phase power supply 230V / 50 Hz.

Protection class: IP54.

Insulation class: Cl. I.

SINGLE-PHASE SPEED CONTROLLER WITH INVERTER

Frequency variation speed regulator (Inverter) with three-phase power supply for the control of one or more three-phase AC motors also not specifically designed for frequency variation regulation.

Enclosure for wall installation featuring IP54 protection.

Maximum length of the power cables to the slave not limited, even in the case of using unshielded cables. Maximum length of the signal cable equal to 30 m in the case of shielded conductors (20 m using unshielded cables); for longer lengths use signal amplifiers. Analog input for speed selection (0-10 V signal; 0-20 mA or PWM).

Digital input (24 V) for connecting external devices, such as adjustment potentiometers. Integrated motor protection; possibility of connection to "TB" thermostats or "TP" thermistors; in the case of simultaneous control of several fans, thermostats or thermistors must be connected in range.

Switching frequency of 16 kHz (to guarantee regular and silent operation of the slave motor).

EMC filter and omnipolar sinusoidal filter (phase-phase and phase-earth) integrated.

Maximum Relative Humidity (RH) of the target environment: up to 85%, in the absence of condensation.

Maximum altitude: 4,000 m (over 1,000 m the nominal current must be reduced by 5% every 1,000 m).

Ambient temperature max continuous operation: 40 ° C

Three-phase power supply: 400V / 50 Hz.

Protection class: IP54.

Insulation class: Cl. I.

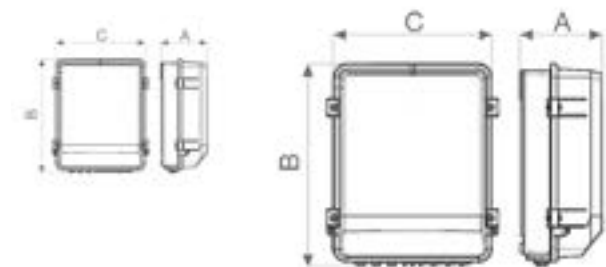

PRODUCTS	CODE	A	B	C	KG
IREM INVERTER 4 M	12815	115	284	240	3.2
IREM INVERTER 6 M	12818	195.5	302	250	5.5

Dimensions (mm)

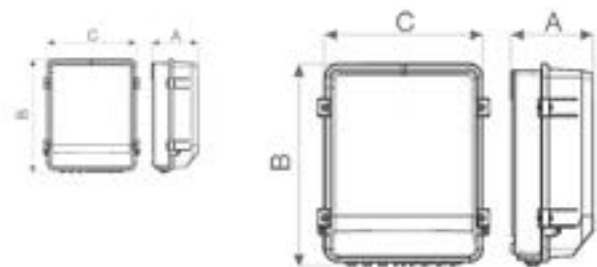

PRODUCTS	CODE	A	B	C	KG
IRET INVERTER 2,5 M	12816	115	284	240	2.5
IRET INVERTER 5 M	12817	195.5	302	250	5.4
IRET INVERTER 8 M	12821	195.5	302	250	6.3

Dimensions (mm)



CONTROLLERS

SINGLE-PHASE AUTOTRANSFORMER SPEED REGULATOR

Autotransformer speed regulator with single-phase power supply designed to control one or more single-phase AC motors up to maximum load (all motor protections must be connected in range). Integrated protection against overheating of the motor and autotransformer.

5 speeds that can be set alternatively using a rotary switch. 230 VAC output for connecting other devices such as servo-motors, actuators and heaters.

Weight: 9.5 kg.

Single-phase 230 V / 50-Hz power supply.

Maximum load: 11 A.

Protection class: IP44.

Insulation class: Cl. I

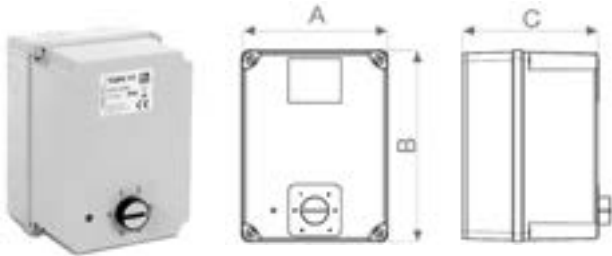

PRODUCTS	CODE	A	B	C
IRM 5 11	12830	185	245	180

Dimensions (mm)

THREE-PHASE AUTOTRANSFORMER SPEED REGULATOR

Autotransformer speed regulator with three-phase power supply (380 - 415 V / 50 Hz) intended for the control of one or more three-phase AC motors up to the maximum load (all motor protections must be connected in range).

3 speeds alternatively set by rotary switch.

Three-phase power supply 380-415 V / 50 Hz.

Protection class: IP56.

Insulation class: Cl. I

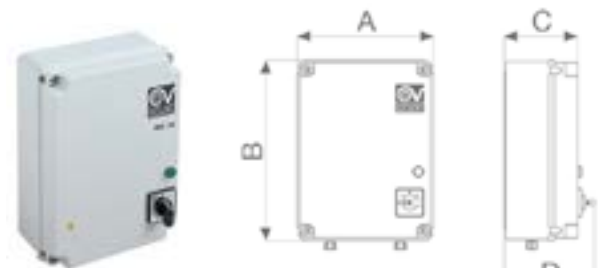

PRODUCTS	CODE	A	B	C	D	KG
IRT 15	12923	236	315	128	157	6.3
IRT 35	12924	236	315	128	157	11.0
IRT 40	12927	236	315	128	157	13.0
IRT 100	12838	270	323	146	163	5.2

Dimensions (mm)

Autotransformer speed regulator with single-phase power supply designed to control one or more single-phase AC motors up to maximum load (all motor protections must be connected in range). 3 speeds alternatively set by rotary switch.

Single-phase power supply 220-240 V / 50-60 Hz.

Protection class: IP56.

Insulation class: Cl. I.

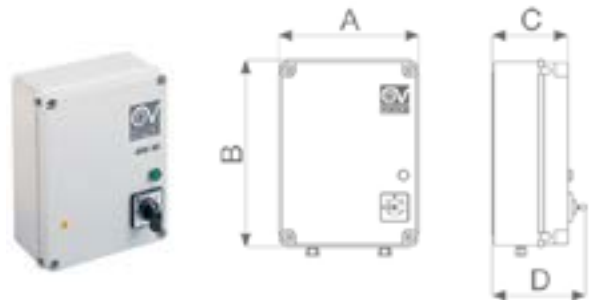

PRODUCTS	CODE	A	B	C	D	KG
IRM 30	12921	200	254	99	128	3.8
IRM 40	12922	236	315	128	157	6.1
IRM 50	12928	236	315	128	157	6.0
IRM 70	12837	166	230	115	118	5.2

Dimensions (mm)

POT

Wall and built-in potentiometer in DIN standard electrical box for external setting of controllers with 0-10 V input and Us supply voltage (max. 12 Vdc / 1 mA). The desired output voltage is gradually adjusted from 0 to the supply voltage V using the knob.

Available functions: on / off; potentiometer. 10 K resistance.

Switch rating: 4 A / 250 Vac - 10 A / 12 Vdc.

Maximum ambient temperature: 35 ° C

Weight: 0.15 kg.

Protection class: IP44 (built-in installation), IP54 (wall installation).

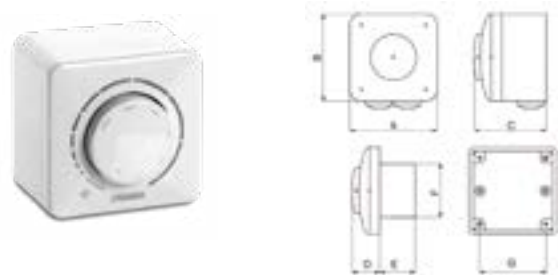

PRODUCTS	CODE	A	B	C	D	E	F	G
POT	12828	82	82	68	26	33	50X50	64

Dimensions (mm)

CONTROLLERS

**ELECTRONIC REGULATOR
SINGLE-PHASE SPEED**

Single-phase electronic speed regulator for controlling single-phase AC motors.
Integrated potentiometer.
Single-phase power supply 220-240 V / 50Hz.
Degree of protection: IP54.
Insulation: Cl. I

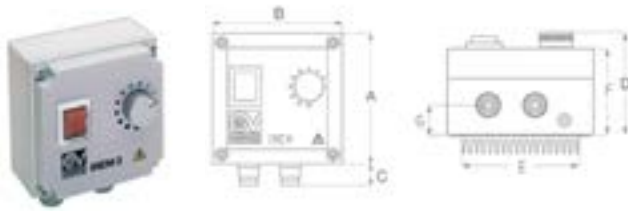

PRODUCTS	CODE	A	B	C	D	E	F	G	KG
IREM 3	12931	130	130	28	92	-	78	25	0.5
IREM 5	12932	130	130	28	92	-	78	25	0.5
IREM 9	12933	130	130	28	92	100	78	25	0.75

Dimensions (mm)

**ELECTRONIC REGULATOR
SINGLE-PHASE SPEED**

Three-phase electronic speed regulator for the control of three-phase AC motors. Enclosure for wall installation featuring IP54 protection. Separate potentiometer for wall installation.
Weight: 0.7 kg.
Three-phase power supply 380-415 V / 50 Hz.
Maximum load: 6 A.
Protection class: IP54.
Insulation class: Cl. I

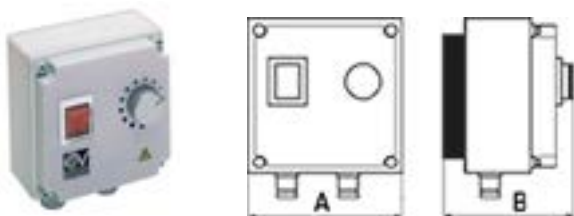

PRODUCTS	CODE	A	B
IRET 6	12934	175	105

Dimensions (mm)

C 1.5 ELECTRONIC REGULATOR

Electronic reversible speed controller.
Wall Installation, with the optional kit SCB (code 22481)
Functions: On/Off, continuous selection of speed.
Peso: 0.2 kg.
Mono-Phase power supply: 220-240 V / 50 Hz.
Maximum load: Cl. II.

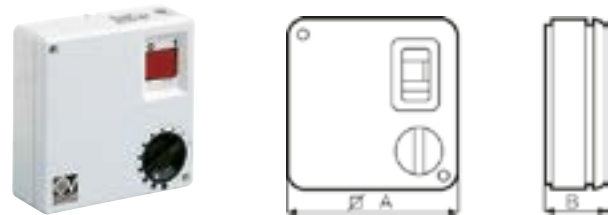

PRODUCTS	CODE	ØA	B
C5.1.5	12966	120	43

Dimensions (mm)

TR-CVT

Three-phase speed switch with 2 positions.
Functions: On / Off, Speed selection (2 alternatives).
Three-phase power supply 380-415 V / 50 Hz.
Protection class: IP65.

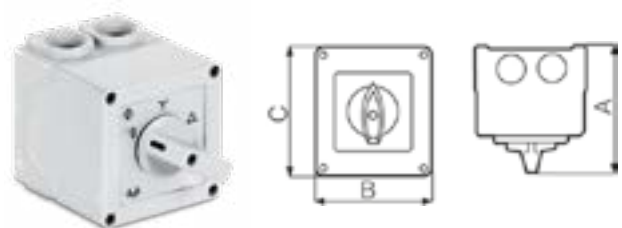

PRODUCTS	CODE	A	B	C
TR-CVT	22910	92	64	64

Dimensions (mm)



CONTROLLERS

GV2

Circuit breaker for ATEX industrial fans.
Weight: 0.26 kg.

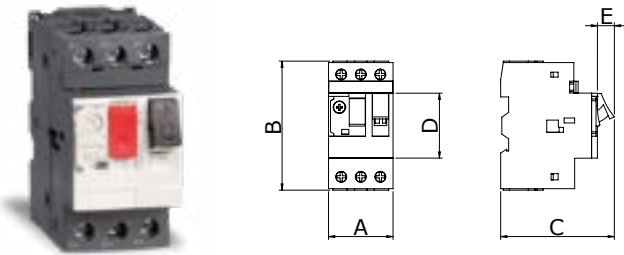

PRODUCTS	CODE	A	B	C	D	E
GV2 ME03	21112	44.5	89	78	45	11
GV2 ME04	21113	44.5	89	78	45	11
GV2 ME05	21114	44.5	89	78	45	11
GV2 ME06	21115	44.5	89	78	45	11
GV2 ME07	21436	44.5	89	78	45	11

Dimensions (mm)

IRET INVERTER

Frequency inverter.



EMC FTR

EMC Filter for IREM/IRET Inverter
Frequency speed controllers.



VORTICE S.p.A
Strada Cerca, 2
Frazione di Zoate
20067 Tribiano
(Milano) Italy
Tel. (+39) 02 906991
Fax (+39) 02 90699625
vortice.com

VORTICE Limited
Beeches House-Eastern
Avenue Burton on Trent
DE13 0BB United Kingdom
Tel. (+44) 1283-49.29.49
Fax (+44) 1283-54.41.21
vortice.ltd.uk

VORTICE Industrial S.R.L.
Via B. Brugnoli 3,
37063 Isola della Scala
(Verona) Italy
Tel. (+39) 045 6631042
Fax (+39) 045 6631039
vorticeindustrial.com

Ventilación Industrial ind., S.L.
Ctra. Camprodon, s/n 17860
Sant Joan de les Abadesses
(Girona) Spain
Tel. (+34) 972720150
casals.com

VORTICE Latam S.A.
3er Piso, Oficina 9-B
Edificio Meridiano Guachipelín,
Escazú San José Costa Rica
PO Box 10-1251
Tel. (+506) 2201.6219
Fax (+506) 2201.6239
vortice-latam.com

**VORTICE Ventilation System
(Changzhou) Co.LTD**
No. 388 West Huanghe Road
Building 19, Changzhou
Post Code: 213000 China
Tel. (+86) 0519 88990150
Fax (+86) 0519 88990151
vortice-china.com

The description and illustrations in this catalogue are understood to be indicative and are not binding. Vortice reserves the right, while not changing the essential characteristics of the models described and illustrated, to modify products whenever necessary and without warning.