



# VORTICEL MP RANGE

Medium-pressure plate axial fans



**Suitable for business or industrial buildings such as halls, factories, warehouses, gyms, etc.**

- **16 models: 6 single phase, 10 three phase.**
- Wing-profiled fan, superimposed for reducing air-turbulence noise, with high-strength, high-stability, polypropylene blades and diecast aluminium hub.
- Steel sheet-metal, polyesterpowder paint-protected frame with streamlined intake nozzle of the correct diameter, to permit easy air passage, and elongated to permit easy attachment to the outlet ducts.
- Asynchronous induction motor with IP55 protection and ballbearing-mounted rotor and double grease seals.
- Circular metal protection grille, with black epoxy-polyester paint finish, which can be easily removed for cleaning and maintenance.
- Electric supply 220-240 V - 50 Hz for single phase model; 220-380 V / 50 Hz and 240-415 V / 50 Hz for three phase model.
- Constant operating temperature between -25°C min. +70°C max.
- Protection rating: IP55.
- Insulation class: I. Ⓡ

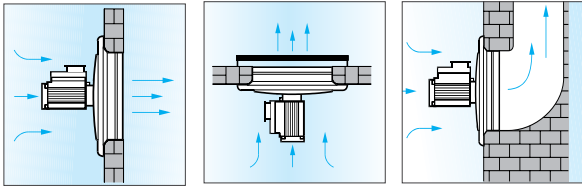

Wiring diagrams shown from page 458

## TECHNICAL DATA

	Models	Code	W	A	POLES	RPM	Max Airflow		Max Pressure		Lp dB(A) a 3 m*	Max °C
							m³/h	l/s	mmH <sub>2</sub> O	Pa		
Single-phase	MP 252 M	42252	205 - 230	1.00 - 1.00	2	2800	2000	56	41	402	70	70
	MP 254 M	42254	60 - 65	0.29 - 0.29	4	1400	1150	319	13	127	53	
	MP 302 M	42202	520 - 550	2.60 - 2.65	2	2800	3500	972	60	588	75	
	MP 304 M	42204	120 - 130	0.55 - 0.55	4	1400	2200	611	13	127	59	
	MP 354 M	42214	240 - 270	1.15 - 1.18			3150	875	18	177	64	
	MP 404 M	42224	300 - 340	1.40 - 1.45			4300	1194	13	127	66	
Three-phase	MP 254 T	42354	60 65	0.35 - 0.20 0.35 - 0.20	4	1400	1150	319	12	118	53	
	MP 302 T	42302	540 560	2.10 - 1.20 2.25 - 1.30	2	2800	3500	972	65	638	75	
	MP 304 T	42304	120 130	0.41 - 0.24 0.41 - 0.24	4	1400	2200	611	15	147	59	
	MP 354 T	42314	185 120	0.62 - 0.36 0.64 - 0.37			3150	875	18.4	180	64	
	MP 404 T	42324	295 330	0.98 - 0.57 1.00 - 0.59			4350	1208	18	177	66	
	MP 454 T	42335	730 780	3.00 - 1.75 3.00 - 1.75			6800	1889	34.6	339	66.5	
	MP 504 T	42344	1100 1200	3.70 - 2.15 3.70 - 2.15			8800	2444	37	363	74	
	MP 506 T	42334	400 430	1.90 - 1.12 1.90 - 1.12	6	1000	6100	1694	17	167	63.5	
	MP 604 T	42374**	2200 2350	7.60 - 4.40 7.60 - 4.40	4	14000	14500	4028	39.6	388	79.5	
	MP 606 T	42364	730 760	3.20 - 1.90 3.20 - 1.90	6	1000	10000	2778	18	177	68.5	

\* Sound pressure level measured at 3 m in free field conditions with long-cased appliance in delivery mode, in accordance with standard EN ISO 3741:2009.



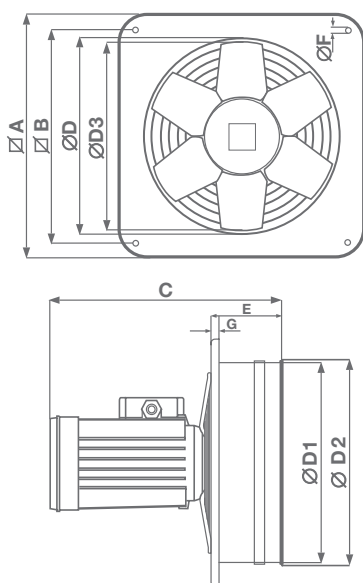

## DIMENSIONS



Models	Ø nom	∇A	∇B	C	Ø D	Ø D 1	Ø D 2	Ø D 3	E	Ø F	G	Kg
MP 252 M	250	320	280	279	256	258.5	264	250	92	8	10	6.1
MP 254 M												
MP 254 T												
MP 302 M	315	380	330	308	308	310.5	316	300	94			9.4
MP 302 T												
MP 304 M												
MP 304 T												
MP 354 M	355	450	380	288	360	362.5	368	350	114	10.2		
MP 354 T												
MP 404 M	400	510	430	308	410	412.5	418	400	114	11.2		
MP 404 T												
MP 454 T	450	630	530	381	460	462.5	468	450	109	12	15	18.5
MP 504 T												
MP 506 T												
MP 604 T	630	760	630	430	610	612.5	618	600	124			19.3
MP 604 T												
MP 606 T	630	760	630	430	610	612.5	618	600	124			28.1
MP 606 T												

Dimensions (mm)

## PRODUCT ACCESSORIES

Models	Code	Product															
		MP 252 M code 42252	MP 254 M code 42254	MP 302 M code 42202	MP 304 M code 42204	MP 354 M code 42214	MP 404 M code 42224	MP 254 T code 42354	MP 302 T code 42302	MP 304 T code 42304	MP 354 T code 42314	MP 404 T code 42324	MP 454 T code 42335	MP 504 T code 42344	MP 506 T code 42334	MP 604 T code 42374	MP 606 T code 42364
	IRM 30 Three position single-phase speed controller	12921	●		●												
	IRM 40 Three position single-phase speed controller	12922	●	●		●	●										
	IRT 15 Three position three-phase speed controller	12923						●		●	●	●					
	IRT 35 Three position three-phase speed controller	12924							●				●	●	●		●
	IRT 40 Three position three-phase speed controller	12927														●	
	IREM 3 Single-phase speed controller	12931	●			●	●	●									
	IREM 5 Single-phase speed controller*	12932	●	●		●	●	●									
	IRET 6 Three-phase speed controller*	12934															
	IREM 9 Single-phase speed controller**	12933	●			●	●	●								●	

\* Can control several fans up to a max of 5 A. \*\* Intended to simultaneously control appliances, up to a max of 9 A.

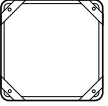
Models	Code	Product															
		MP 252 M code 42252	MP 254 M code 42254	MP 302 M code 42202	MP 304 M code 42204	MP 354 M code 42214	MP 404 M code 42224	MP 254 T code 42354	MP 302 T code 42302	MP 304 T code 42304	MP 354 T code 42314	MP 404 T code 42324	MP 454 T code 42335	MP 504 T code 42344	MP 506 T code 42334	MP 604 T code 42374	MP 606 T code 42364
	DPU 250 Spacer for panel installation	52151	●	●				●									
	DPU 300 Spacer for panel installation	52251			●	●			●	●							
	DPU 350 Spacer for panel installation	52351					●				●						
	DPU 400 Spacer for panel installation	52451						●				●					

Description and sizes on page 1325; System components on page 330

## PERFORMANCE CURVES

MP 252 M code 42252

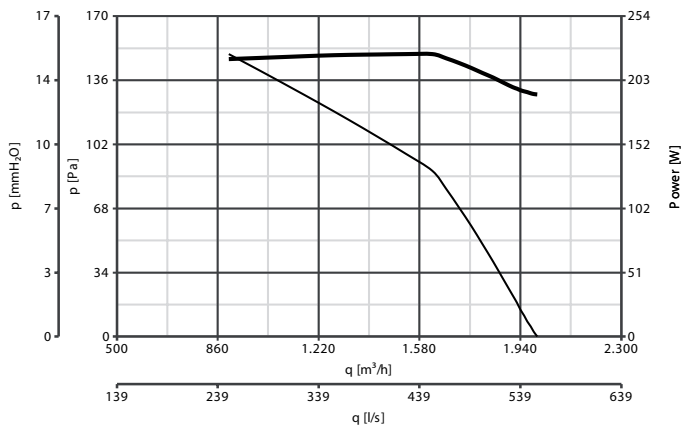

MP 254 M code 42254

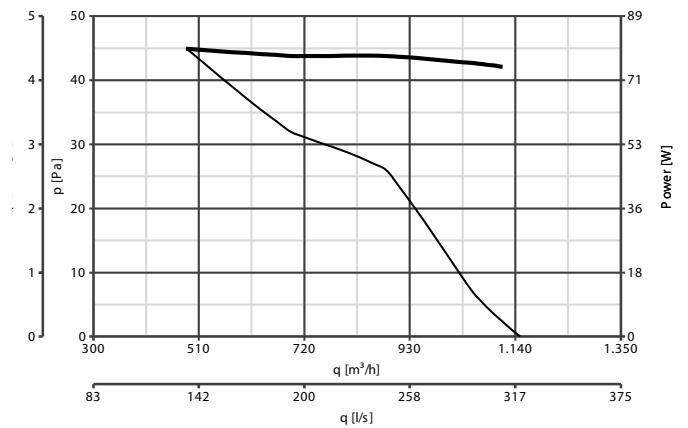

MP 302 M code 42202

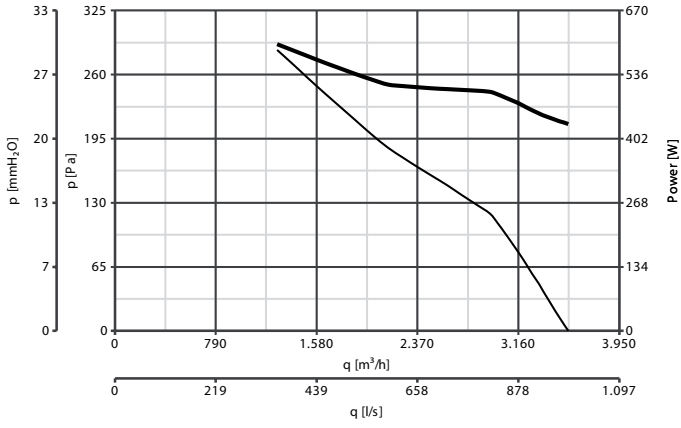

MP 304 M code 42204

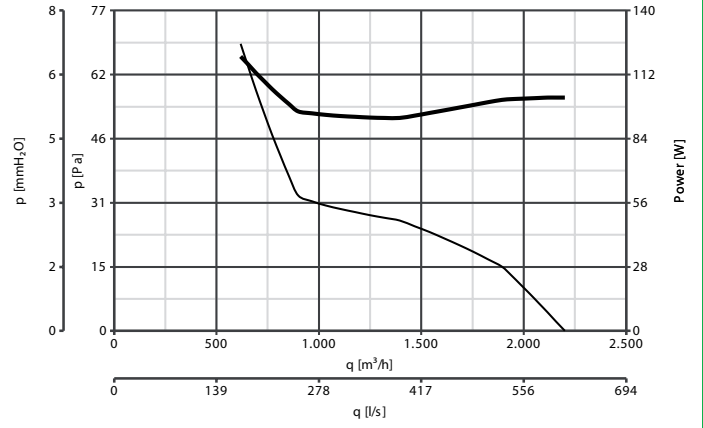

MP 354 M code 42214

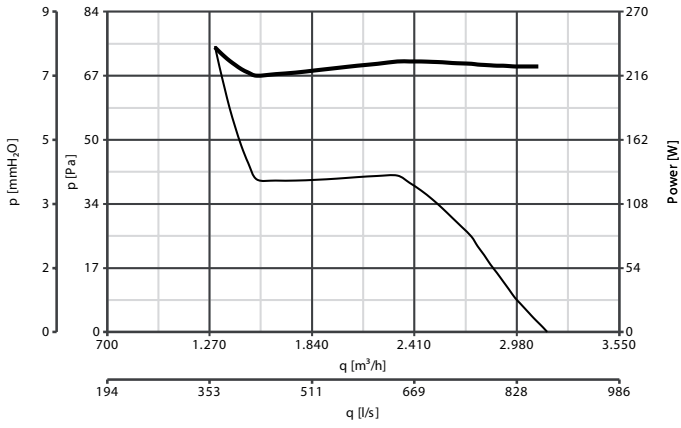

MP 404 M code 42224

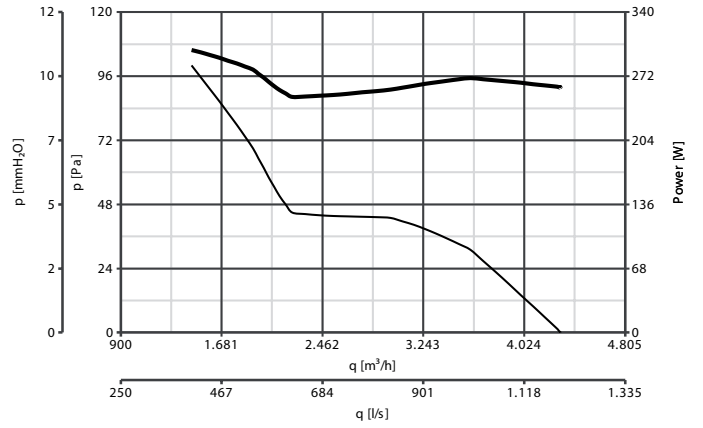

MP 254 T code 42354

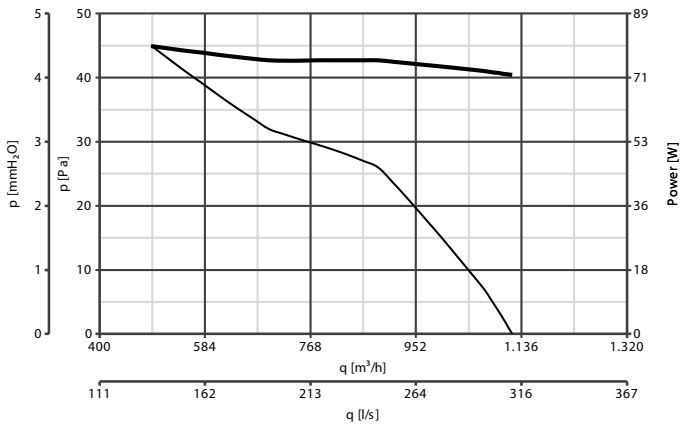

MP 302 T code 42302

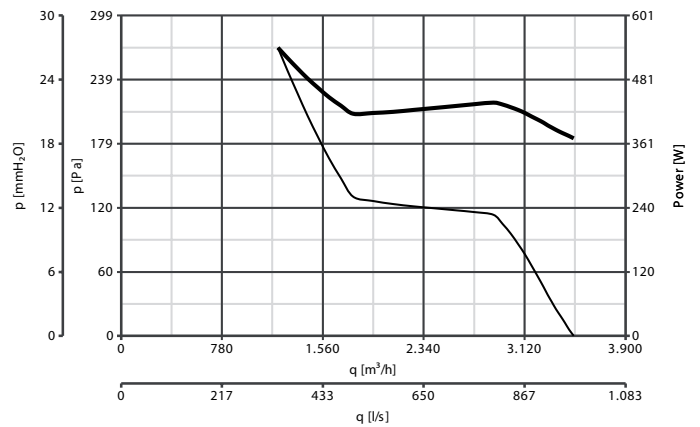

**MP 304 T code 42304**

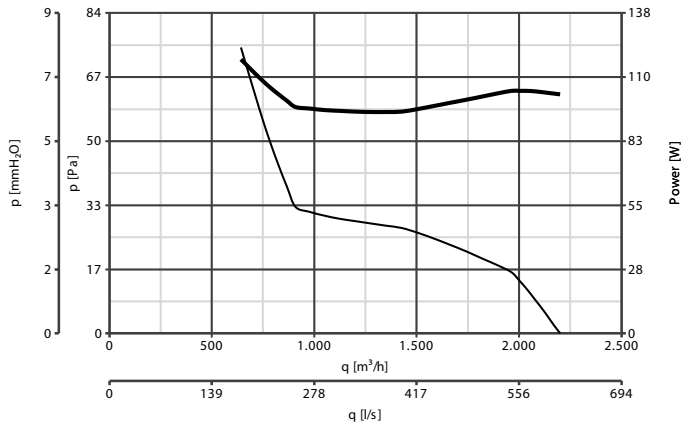

**MP 354 T code 42314**

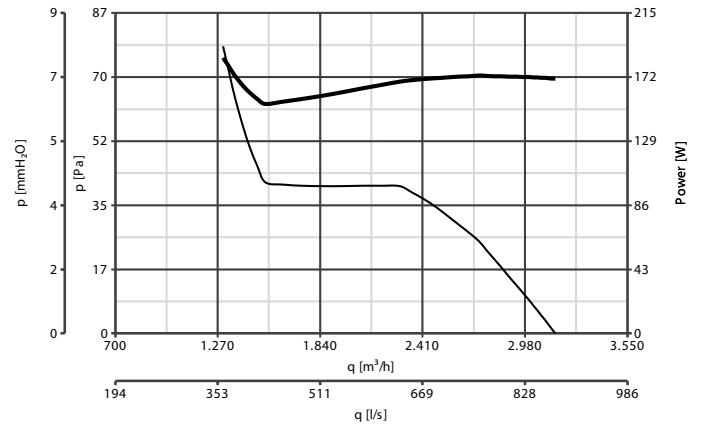

**MP 404 T code 42324**

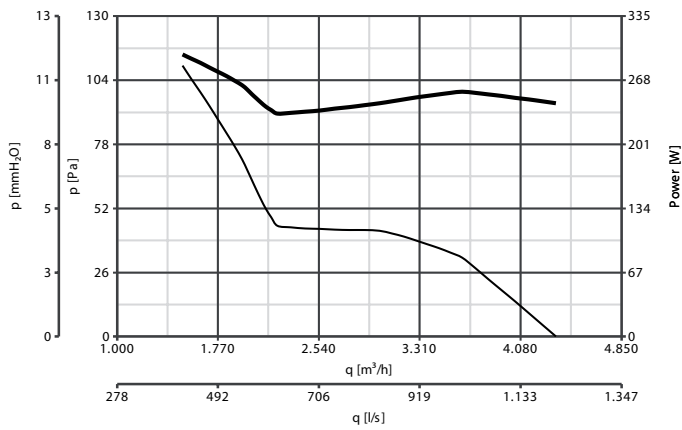

**MP 454 T code 42335**

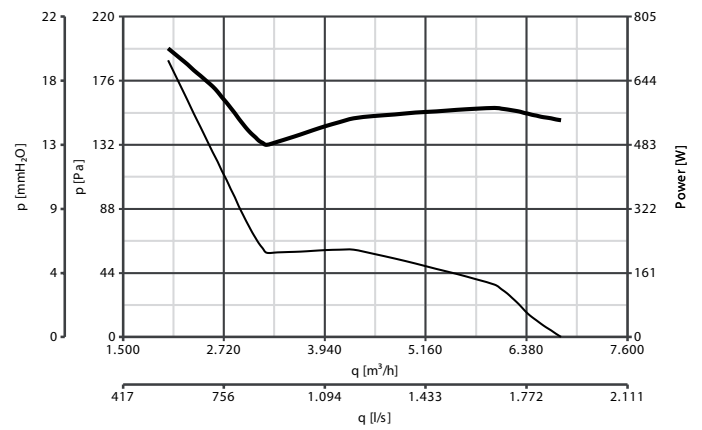

**MP 504 T code 42344**

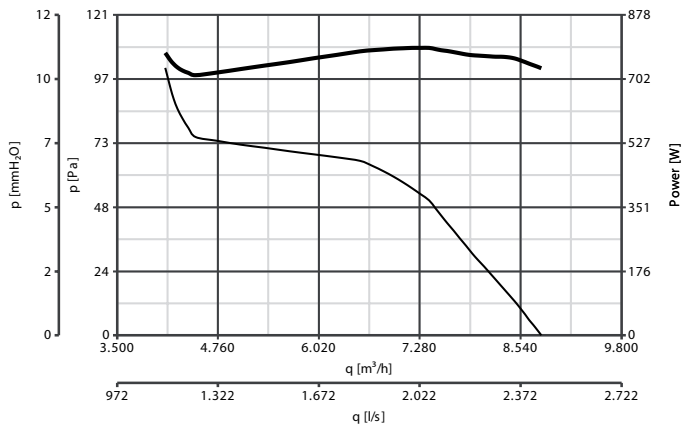

**MP 506 T code 42334**

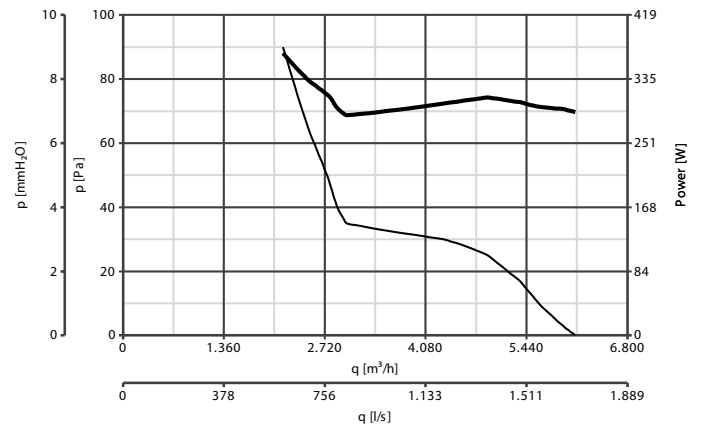

MP 604 T code 42374

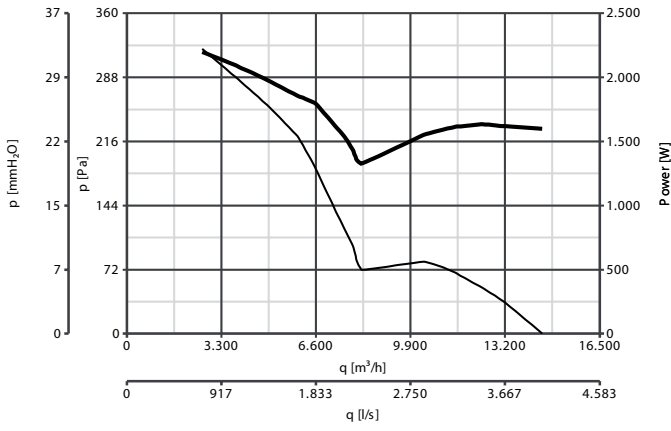

MP 606 T code 42364

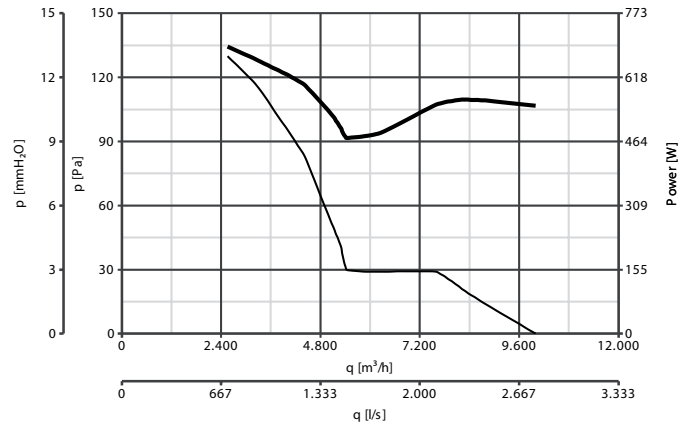

— Delivery    — Consumption